



This is a digital copy of a book that was preserved for generations on library shelves before it was carefully scanned by Google as part of a project to make the world's books discoverable online.

It has survived long enough for the copyright to expire and the book to enter the public domain. A public domain book is one that was never subject to copyright or whose legal copyright term has expired. Whether a book is in the public domain may vary country to country. Public domain books are our gateways to the past, representing a wealth of history, culture and knowledge that's often difficult to discover.

Marks, notations and other marginalia present in the original volume will appear in this file - a reminder of this book's long journey from the publisher to a library and finally to you.

### **Usage guidelines**

Google is proud to partner with libraries to digitize public domain materials and make them widely accessible. Public domain books belong to the public and we are merely their custodians. Nevertheless, this work is expensive, so in order to keep providing this resource, we have taken steps to prevent abuse by commercial parties, including placing technical restrictions on automated querying.

We also ask that you:

- + *Make non-commercial use of the files* We designed Google Book Search for use by individuals, and we request that you use these files for personal, non-commercial purposes.
- + *Refrain from automated querying* Do not send automated queries of any sort to Google's system: If you are conducting research on machine translation, optical character recognition or other areas where access to a large amount of text is helpful, please contact us. We encourage the use of public domain materials for these purposes and may be able to help.
- + *Maintain attribution* The Google "watermark" you see on each file is essential for informing people about this project and helping them find additional materials through Google Book Search. Please do not remove it.
- + *Keep it legal* Whatever your use, remember that you are responsible for ensuring that what you are doing is legal. Do not assume that just because we believe a book is in the public domain for users in the United States, that the work is also in the public domain for users in other countries. Whether a book is still in copyright varies from country to country, and we can't offer guidance on whether any specific use of any specific book is allowed. Please do not assume that a book's appearance in Google Book Search means it can be used in any manner anywhere in the world. Copyright infringement liability can be quite severe.

### **About Google Book Search**

Google's mission is to organize the world's information and to make it universally accessible and useful. Google Book Search helps readers discover the world's books while helping authors and publishers reach new audiences. You can search through the full text of this book on the web at <http://books.google.com/>

PROPERTY OF  
*University of  
Michigan  
Libraries*

1817



---

ARTES SCIENTIA VERITAS

---



PROPERTY OF  
*University of  
Michigan  
Libraries*

1817



---

ARTES SCIENTIA VERITAS

---

PROPERTY OF  
*University of  
Michigan  
Libraries*

1817



---

ARTES SCIENTIA VERITAS

---

PROPERTY OF  
*University of  
Michigan  
Libraries*

1817



---

ARTES SCIENTIA VERITAS

---











THE TEACHING BOTANIST



**THE MACMILLAN COMPANY**

NEW YORK · BOSTON · CHICAGO  
ATLANTA · SAN FRANCISCO

**MACMILLAN & CO., LIMITED**

LONDON · BOMBAY · CALCUTTA  
MELBOURNE

**THE MACMILLAN CO. OF CANADA, LTD.**

TORONTO

THE  
TEACHING BOTANIST

A MANUAL OF INFORMATION UPON  
BOTANICAL INSTRUCTION

INCLUDING

OUTLINES AND DIRECTIONS FOR A SYNTHETIC  
GENERAL COURSE

BY  
WILLIAM F. GANONG, PH.D.  
PROFESSOR OF BOTANY IN SMITH COLLEGE

*SECOND EDITION*

New York  
THE MACMILLAN COMPANY  
1910

*All rights reserved*

COPYRIGHT, 1899, 1910,

By THE MACMILLAN COMPANY.

---

Set up and electrotyped. Published June, 1910.

Norwood Press

J. S. Cushing Co. — Berwick & Smith Co.  
Norwood, Mass., U.S.A.

Science  
GK  
51  
.G19  
1910

## PREFACE

ALTHOUGH this book retains the title, the plan, and the spirit of the first edition, it has been rewritten almost throughout. When I came to revise it, I found, for one thing, that I had learned a good deal in the interval, and, for another, that progress in botanical education in the past decade had been surprisingly great. Therefore, upon almost every page it was possible to make some change for the better. And this bit of reminiscence suggests also a prophesy, to this effect, — that great as the progress of the last ten years has been, it is little in comparison with that which the coming decade will witness. I believe that the next great wave of botanical interest which will sweep over the country will be educational, and that it will lift our science into more nearly its rightful place in the life and interests of the community, and will leave botanical education a recognized and permanent department of botanical investigation. This word to the ambitious young botanist should be sufficient, while as for myself, I ask nothing better than to have some part in this difficult but meritorious service.

While I am sure that in most respects this edition is a marked advance over its predecessor, it exhibits one

209612

feature with which I am ill pleased, and that is its great increase in length. For this I can only plead, in somewhat rueful explanation, a reason suggested more than once in the following pages, — that the aim has been to make the work monographic of its subject, and the subject has grown rapidly of late. The book no doubt contains much that to some will seem needless, and to others commonplace; but I have reason to believe that there are those to whom the same matters will be new, and contain something of information and suggestion.

In the preparation of this edition I have not hesitated to seek aid wheresoever I thought I could find it. I have made the best use that I could of the many educational books from those of ASA GRAY down to the newer works by my own immediate colleagues. I have also availed myself of the writings, and still more of the advice, of my two honored fellow-craftsmen in the study of botanical-educational problems, Professor O. W. CALDWELL, of the School of Education in the University of Chicago, and Professor F. E. LLOYD, of the Alabama Polytechnic Institute, formerly of Teachers College in Columbia University, and author of another work upon the teaching of Botany. Certain of the illustrations have been furnished by others, as acknowledged at suitable places in the text, while the shaded line cuts, forming figures 9, 21, 28, 37, 38, representing apparatus of my own invention, have been supplied by the makers of the pieces, the BAUSCH & LOMB OPTICAL COMPANY. I have



had constant and loyal aid from the head gardener of Smith College, Mr. EDWARD J. CANNING, who has not only contributed the section on window gardening, in Chapter VII, but has helped in other ways by his skilled interest in educational gardening generally. I have had, also, an advantage of another kind in the use of the unsurpassed facilities provided by the Lyman Plant Houses at Smith College, — a far-sighted and generous memorial gift which I desire to see made as widely useful as possible. Finally, one of the greatest of my obligations is to Miss HELEN A. CHOATE, Assistant in Botany in Smith College, whose critical and skilful reading of manuscript and proofs has been very much to the advantage of the book. To all of those I have mentioned, and to some others who have cheerfully furnished aid in minor ways, I wish here to express my appreciative and grateful acknowledgment.

W. F. GANONG.

NORTHAMPTON, MASS.,  
April 15, 1910.



# CONTENTS

INTRODUCTION . . . . .	PAGE I
------------------------	-----------

## PART I

### *CHAPTERS ON SUBJECTS IMPORTANT IN BOTANICAL EDUCATION*

#### I

ON THE PLACE OF THE SCIENCES IN EDUCATION, AND OF BOTANY AMONG THE SCIENCES . . . . .	7
--	---

#### II

ON THE QUESTION: WHAT BOTANY IS OF MOST EDUCA- TIONAL WORTH? . . . . .	30
---	----

#### III

ON THE TRAINING AND TRAITS OF THE GOOD BOTANICAL TEACHER . . . . .	52
---	----

#### IV

ON THE METHODS AND MARKS OF GOOD BOTANICAL TEACH- ING . . . . .	73
--	----

#### V

ON SCIENTIFIC, MAINLY BOTANICAL. DRAWING AND DE- SCRIPTION . . . . .	89
---	----

	PAGE
VI	
ON BOTANICAL LABORATORIES AND THEIR EQUIPMENT . . . . .	109
VII	
ON BOTANICAL COLLECTIONS AND OTHER ILLUSTRATIONS . . . . .	141
VIII	
ON BOTANICAL BOOKS AND THEIR USE . . . . .	176
IX	
ON SOME COMMON ERRORS PREJUDICIAL TO GOOD BOTANICAL TEACHING . . . . .	227

## PART II

*OUTLINES AND DIRECTIONS FOR A SYNTHETIC  
GENERAL COURSE IN THE SCIENCE OF BOTANY*

INTRODUCTION . . . . .	249
------------------------	-----

## DIVISION I

## THE STRUCTURE AND FUNCTIONS OF PLANTS

I. The Structure of Seeds . . . . .	257
II. The Morphology of Seeds and Embryos . . . . .	264
III. The Ecology of Seeds . . . . .	272
IV. The Germination of Seeds and Growth of Embryos to Seedlings . . . . .	276
V. The Development of Seedlings into Adult Plants . . . . .	283
VI. The Mature Plant . . . . .	289
VII. The Morphology and Ecology of Winter Buds . . . . .	297
VIII. The Special Morphology and Ecology of Leaves, Stems, and Roots . . . . .	303
IX. The Tissue Systems (or Anatomy) of Plants . . . . .	310

## CONTENTS

xi

	PAGE
X. The Structure of the Cells of the Higher Plants . . . . .	321
XI. The Anatomy of Leaves . . . . .	327
XII. The Anatomy of Stems . . . . .	335
XIII. The Anatomy of Roots . . . . .	341
XIV. The Structure of Flowers . . . . .	348
XV. The Morphology of Flowers . . . . .	359
XVI. The Ecology of Flowers . . . . .	367
XVII. The Morphology and Ecology of Fruits . . . . .	377

## DIVISION II

### THE NATURAL HISTORY AND CLASSIFICATION OF THE GROUPS OF PLANTS

I. The Algæ . . . . .	386
II. The Fungi . . . . .	393
III. The Moss Plants, or Bryophytes . . . . .	399
IV. The Fern Plants, or Pteridophytes . . . . .	401
V. The Seed Plants, or Spermatophytes . . . . .	405

## APPENDIX

THE PRINCIPAL STANDARD OR UNIT COURSES IN GENERAL BOTANY FORMULATED BY REPRESENTATIVE COMMITTEES IN AMERICA . . . . .	413
---	-----



## INTRODUCTION

THIS is a book of ideals. In its pages I have tried to set forth the chief factors involved in the best of botanical teaching, well believing that it is good for each person to hitch his wagon to a star. It is true that we may never be able to attain to these, any more than to other ideals, for all alike they are veritable will o' the wisps which waft themselves farther away just as we reach forth to grasp them. However, this matters but little, since man is made in such fashion that pursuit holds more joy than possession, and visions more charm than realities. That we cannot attain to our ideals is, therefore, the least of objections against them. They have, however, at least one positive merit. They can serve as a perennial balm for the soul, or a kind of a spiritual radium, sending forth a perpetual emanation to keep work and life aglow. Besides, they may be made to do service in practical ways, as definite goals to be aimed at, or as standards of value to which we may point those objectors who question the aim of our efforts. So, from all points of view ideals are in place, and in generous measure, in a book that is given to teaching.

This is a practical book. In its pages I have tried to collect the results of experience gained by successful

teachers down to this day, in so far as these are concerned with general courses in this science. I have sought to explain at some length the various methods, materials, and instruments, which have been tested and found to be good, to discuss the merits and defects of matters which still are in question, and to give warning against sundry fallacies which, while fair seeming in theory, have been found useless in practice. I have tried also to set down, the clearest that I can, the various practical matters which the teacher will find it useful to know, not forgetting the little time-saving turns and strength-saving devices, both of hand and of mind, which, while simple enough when known, are not likely at first to be thought of. I know I have treated most subjects more fully than any one teacher will care for, but I have aimed to treat all matters as fully as any one teacher can need. In a word, I have tried to make the work in a manner monographic of matters connected with elementary or general science courses in Botany. Moreover, and here is a matter of consequence, I have tested for myself, in class room and laboratory, practically every matter that is treated in these pages; and the recommendations, therefore, are based upon actual experience under the administrative conditions which the teacher has to meet. If the book has any merit at all, it will be found to lie chiefly in this practical foundation.

It may seem at first sight that the book has a title too



wide for its contents, for it centers almost wholly in the teaching of its subject in a general course in high school or college. Here, however, lie our present-day problems. Above this grade, in advanced college or university work, the methods and materials are well organized and productive of satisfactory results, while in the lower grades, involving the nature courses of the primary schools, the problems are of another kind, being as much psychological as scientific. In the general science courses, however, those lying just on either side of the boundary between high school and college, is confusion, ferment, and need for organization; and here is the principal demand for discussion, investigation, and agreement. I think, therefore, that the book is not badly named.

The nature of my subject has imposed its own method of treatment. It calls first for a systematic discussion of the various matters of theory and practice involved in botanical teaching; and this I have given in Part I, as a series of chapters devoted to the several topics. Then it requires an attempt to combine the best theory with the conditions and exigencies of actual laboratory administration; and this I present in Part II in the form of outlines and suggestions for a course designed to embody an harmonic optimum between the various conditions involved. Finally, I reproduce in an Appendix two official documents of the first practical importance to the botanical teacher.

In explanation of the exact scope of this book, there is a point that needs particular emphasis. The book is concerned with the teaching of Botany as a science in high school and college, and has nothing to do, directly, with the nature-study which belongs to the lower schools. Yet, as we all know, most of our students come into high school and college with so scant a knowledge of the commonest facts about plants, and with so little idea of how to use their senses and minds upon natural objects, that most of our teachers find it needful to make their courses, even for college students, more or less of the nature-study type. Concession must, of course, be made to this condition, to an extent and in a way, however, which must be left to the judgment of the individual teacher; but there is no question, I believe, that we ought to treat the condition as temporary, and should expect the lower schools to send us students sufficiently grounded in common fact knowledge and in the use of the natural powers to enable them to profit by the later treatment of the subject as a science, — that is, as organized knowledge and disciplinary method. The pressure should be kept towards a science course for high school and college, and it is the development of such a course which is the aim of this book.

PART I

*CHAPTERS ON SUBJECTS IMPORTANT IN  
BOTANICAL EDUCATION*

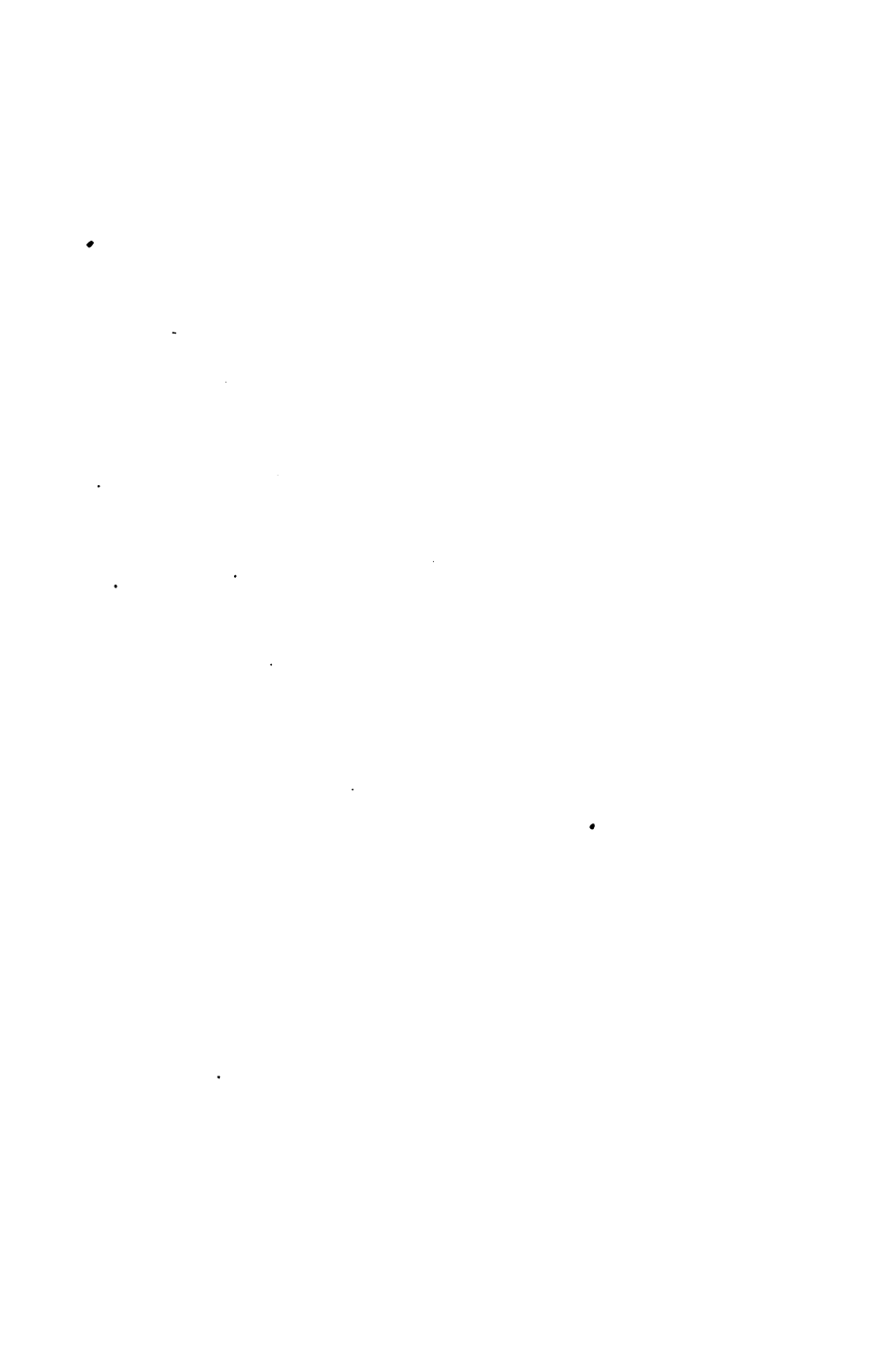

## I. ON THE PLACE OF THE SCIENCES IN EDUCATION, AND OF BOTANY AMONG THE SCIENCES

It is essential to the success of the teaching botanist that he acquire a definite and objective conception as to the place of his subject in education. This he must develop for himself through observation, reflection, and discussion, to the last of which, however, I can contribute something by recording here the results of a good deal of study of this subject.

What is the real aim of education? This question though old is yet ever new, nor is there any matter of equal importance on which there is so little agreement. Its value in the abstract is everywhere granted, but men differ widely in their views as to the relative nature and worth of information, knowledge, learning, intellectual discipline, culture, and practical training. Now the cosmic basis of education seems to me this. Man is an animal with a weak and weaponless body inferior to that of many of the brutes, yet he has risen to domination over them, and much more of nature besides, through the possession of one supreme weapon, — mind. To enable him both to make the best present use for his own advantage,

and also to utilize the highest potentialities for the benefit of his community, of his single great weapon, — that is the fundamental aim of education.

But although the aim may be simple, its attainment is hard. For one thing the mind, developed in adaptation to ages of savage struggle for physical existence, still finds more delight in the familiar field of strife with real or imagined foes than in the stranger ways involved in the quiet pursuits of peace, while at the same time it is so strangely complex and unstable that its cultivation presents one of the most difficult of human tasks. Moreover, the need for the highest skill and wisdom in education is inadequately appreciated by those whose duty it is to make provision for them, while at the same time the experts differ much upon some of the most vital of its problems. Nevertheless education, like humanity itself, moves surely, though slowly and clumsily, forward; and we are coming with time to a better understanding of the fundamental educational verities.

Of all educational problems the foremost is this: to establish the harmonic balance between mind training for general culture and the training of the mind for success in the practice of a particular business or profession. To most of our people, and especially to those of remoter or poorer communities, practical training seems the only worthy aim of education; and it is difficult to make them comprehend the reason of training for culture, whose

value is understood as a rule only by those who have experienced it. Yet training for culture is at least as important a part of education as training for a profession, since in a general way it is true that while the latter promotes the interests of the individual, the former tends to make him a better companion, neighbor, and citizen, which is no small matter when men must dwell together as members one of another. Cultural training is sometimes justified by the statement that the mind becomes a more efficient tool for any practical service if it has first been brought into a condition of general sharpness and polish. This is true, but it is not the highest justification of culture. That is found rather in the better sense of values, the truer perspective, the deeper knowledge of man in relation to other things, which cultural training gives. Certain great things which have profoundly influenced human thought and action have been and are now in the world; that is reason enough why an educated man should have some personal knowledge of them. To a considerable and a steadily increasing degree, subjects useful professionally can be made of value for culture as well, so that vocational and cultural education may to a considerable extent be coincident. Nevertheless there must always remain, from the nature of the case, a large number of subjects invaluable to culture which can never perform any practical service. Educational opinion is now well-nigh unanimous in the belief

that the best education is the one in which a cultural education, represented among us by the usual high school and college course, precedes the professional training given by the special schools. It is true, all cannot achieve such an education, but it is the ideal for which all should strive.

Any system of education for culture has to reckon with the great number of different phases or departments of human knowledge. But these have long been too many and vast for any one mind to encompass, even as to their elements, while all have become so detailed that it is task enough to attain a moderate proficiency in one. This marvelous widening and deepening of knowledge are working a complete transformation in our ideal of the cultured man. Time was when all educated men knew the same things, discussed the same questions, and read the same books. Now men of equal culture know very different things, debate quite unlike problems, and hear nothing of one another's works; and their common ground of meeting lies no longer in scholarly knowledge, but in the general affairs of humanity. We are coming to believe, indeed, that culture consists less in extensive knowledge than in intelligent sympathy; not so much in stores of particular facts as in ability to transmute any suitable facts into knowledge; not only in well-grounded conviction, but in toleration; not alone in absorption of wisdom, but as well in its radiation; in appreciation of public and humanitarian service; in pa-



triotism that is above party and profit; in a word, in the development of the forces and refinements of character. For purposes of practical educational administration the matter is sometimes expressed in the saying, — know something of everything and everything of something. Yet this is a bit too sweeping, and a safer guide is this, — know much of something, and something of many things. This, I believe, expresses the practical form of the aim of cultural education.

This view of culture is admitted more widely in theory than it is embodied in practice. For it implies that all the great and approved divisions of human knowledge should rank as equals, whereas in fact they do not, even in the minds of many highly educated men, who claim that some divisions of knowledge are inherently more cultural than others. In a general way the leading subjects of educational importance group themselves into two classes, one including those subjects, viz. literature, art, music, languages, and history, which appeal chiefly to the feelings and are called “the humanities,” and the other including those subjects, viz. mathematics, and the natural sciences (together with philosophy), which appeal chiefly to the reason and are called, somewhat loosely, “the sciences.” Not only do many people claim, but our educational practice assumes, that the humanities are innately more cultural than the sciences, which assumption is made manifest in many practical ways, —

in college entrance requirements, where the humanities are in overwhelming preponderance; in the construction of college curricula, where an amount of attention to the humanities is encouraged as "desirable concentration," which if offered to the sciences is vetoed as "narrowing specialization"; in the prevalent assumption that experts in the sciences are uncultured bores unless they know much of the humanities, while specialists in the humanities lose no cultural caste if wholly ignorant of the sciences; and in the high respect accorded the pursuit of the humanities as avocations or recreations in comparison with the somewhat amused toleration generally extended to a similar pursuit of the sciences. Much of this difference of attitude towards the two classes of subjects is due simply to the inertia of the older views which were prevalent in pre-scientific days, and will spend itself and vanish with time. A part of it is just, being based on the still inferior teaching of the sciences, and it will disappear as that is improved, — a subject on which some further comments will be found a few pages later. But, aside from these adventitious circumstances, is it true that the sciences are inherently less cultural than the humanities? This must of necessity be matter of opinion rather than of proof, and the reader must draw his own conclusions from such data as he can gather, — in which, however, let him include the material of the following paragraphs.

X The innate capacity of the sciences to rank as equals of the humanities as cultural subjects in education has been advocated by many distinguished leaders, of whom the greatest was HUXLEY, and in this country President ELIOT. In their works, notably the *Science and Education* of the former and *Educational Reform* of the latter, the reader will find full discussions, alike illuminating and attractive, of this important matter. The cultural value of any subject depends chiefly upon its power to do three things, — to train the intellect, to stimulate the imagination, and to impart useful knowledge. As to training of the intellect, consider this greatest of all definitions of Science: that of HUXLEY.

Science is, I believe, nothing but *trained and organized common sense*, differing from the latter only as a veteran may differ from a raw recruit: and its methods differ from those of common sense only so far as the guardsman's cut and thrust differ from the manner in which a savage wields his club. The primary power is the same in each case, and perhaps the untutored savage has the more brawny arm of the two. The *real* advantage lies in the point and polish of the swordsman's weapon; in the trained eye quick to spy out the weakness of the adversary; in the ready hand prompt to follow it on the instant. But, after all, the sword exercise is only the hewing and poking of the clubman developed and perfected.

So, the vast results obtained by Science are won by no mystical faculties, by no mental processes, other than those which are practiced by every one of us, in the humblest and

meanest affairs of life. (*Science and Education*, edition of 1894, p. 45.)

As to the power of Science to stimulate the imagination, these are the words of President ELIOT:—

The imagination is the greatest of human powers, no matter in what field it works—in art or literature, in mechanical invention, in science, government, commerce or religion, and the training of the imagination is, therefore, far the most important part of education. . . .

Contrast this kind of constructive imagination with the kind which conceived the great wells sunk in the solid rock below Niagara that contain the turbines that drive the dynamos, that generate the electric force that turns thousands of wheels and lights thousands of lamps over hundreds of square miles of adjoining territory; or with the kind which conceives the sending of human thoughts across three thousand miles of stormy sea instantaneously on nothing more substantial than ethereal waves. There is going to be room in the hearts of twentieth century men for a high admiration of these kinds of imagination as well as for that of the poet, artist, or dramatist.

It is one lesson of the nineteenth century, then, that in every field of human knowledge the constructive imagination finds play—in literature, in history, in theology, in anthropology, and in the whole field of physical and biological research. (Address on The New Definition of the Cultivated Man, in *Science*, 18, 1903, p. 78.)

As to knowledge, each must judge for himself whether it is not as conducive to gentle conduct, to good citizen-

ship, and to sympathy with all grades of humanity, to know something of the forces with which man to-day is subduing nature, of the processes going on in our own bodies, of the basis of the germ nature of disease, of what moves an electric car, of the meaning of the procession of the seasons with their manifold phenomena, as to know the arts and literatures, ancient or modern, fine though these things be.

There is, however, one respect in which the sciences are now, and must ever remain, of less cultural importance than the humanities. Man as a whole is much more a feeling than a thinking being; and therefore the great majority of people can best be influenced, or educated, through studies which appeal to their feelings,—that is to say, through the humanities. Nevertheless there are some, and they a considerable proportion, who can best be reached through the reason, and for them the sciences have the higher cultural value. Now a minority has rights, and although the humanities must always hold quantitatively a greater place in education than the sciences, these are entitled to a qualitative equality of educational rank and dignity, expressed in equally efficient and continuous instruction, and in the same status of requirement or election, throughout the educational system from kindergarten to college. As a matter of fact the sciences do not now possess this rightful equality, and it is our duty to see that they shall,—first, by

deserving it through improvements in our teaching, and second, by insisting thereon upon all suitable occasions.

For the attainment by the sciences of equal educational rank with the humanities, continuity of good instruction throughout the grades is indispensable. Because of their many generations of experience the humanities have been able to develop, immensely to their profit, efficient and measurably standardized instruction, adaptive both as to matter and methods, for all grades from the lowest schools to the college. But, as everybody knows, while instruction in the sciences is fairly good in the higher grades, we have not as yet any consistent or continuous system of instruction in nature knowledge in the lower schools, and our scientific education suffers greatly from this deficiency. In the first place, poor or discontinuous instruction in nature-study deprives the scientifically-minded student of the opportunity to find early his chief interest. Again, it gives to most students a prejudice against subjects in which their experience has been so limited, or, often, so unfortunate. And, finally, it deprives students, at a time when their minds are in the most formative and receptive state, of training in the natural inductive methods of acquiring knowledge, while immersing them instead in excessive text-book and deductive work, which tends always to make them distrustful of their own powers, and leads them to regard as the only real sources of knowledge the thoughts of others

formally presented in printed books. In consequence most students come into high school and college not only without a good foundation in natural fact knowledge, but even with a prejudice against all matters scientific; and the revival in them of that spirit of inductive inquiry which they originally possessed, but so often have lost through disuse and the pressure of other activities, becomes the hardest task of the teacher. The teaching botanist should, therefore, from the standpoint of his own interests if no other, give every possible aid and comfort to his nature-study colleagues in their efforts to develop continuous and efficient instruction in nature knowledge in the primary schools.

The conception of cultural education as requiring a good training in some one of the worthy departments of knowledge, involves this question: What shall determine for each student that main department of study? As to this all opinion is in agreement; he should be allowed to choose that which is most congenial, and in which, on that account, he will attain the highest proficiency. Experience has taught that the mind like the body derives more good from an exercise in which it can take an interest than from one in which it does not. This is the fundamental principle of the elective system, and it is, when suitably safeguarded, of very wide educational application. Indeed, this general idea of making the individual's first interest the center of his education is equally applicable to

all grades from the kindergarten to the university, although, naturally, with differences in the mode of its practical application according to the grade. In the lower grades it will consist simply in the utilization by the skilled teacher of a student's first interest as a means of arousing and stimulating him to better effort; but in the upper grades the student should be encouraged to some definite concentration upon his chief interest, with a permission of some limited election in the high school, a more liberal allowance in college, and as much as he pleases in the university.

Our idea of culture involves, however, not alone the need for a thorough knowledge of something, but likewise some knowledge of many things; and therefore the elective system ought logically to involve, along with the choice of a main subject, the obligation to learn the elements of a number of others. Thus only, indeed, can be met a frequent and just objection to the elective system in its extreme form, viz. that in permitting the student to choose and concentrate solely upon that which he likes, he loses the power, acquired only through effort, to turn his mind at need to uncongenial tasks. There is really nothing in the principle of election to weaken the training power of education, as the example of the technical and professional schools, which illustrate election on a large scale, abundantly proves; but certainly that result does often follow in actual practice. A rigid drill in some other subjects, whether he likes them or not, is, in my opinion, as



essential a part of any student's education as is the most devoted pursuit of things that are congenial. But the point now of concern is this, that such drill will be more effective if linked with a voluntary interest in a congenial main subject. This brings us, in turn, to the matter of the relation which ought to exist between a student's elected main subject and those he is required to take. The one ought not to rise abruptly anywhere out of a dead level of the others, as a factory chimney towers up from a flat roof, but rather it should form the central height of a mass sloping gradually away therefrom, as a mountain peak runs curving symmetrically down to the plain. That is, the minor subjects should be grouped about the principal one in the order of their bearing upon it, some receiving more attention and some less. In the higher grades, in high school and especially in college, this principle finds its logical expression in a group system, wherein the minor subjects are linked to the main subject in that kind and degree shown by educational experience to be advantageous. The student may choose his group, but having chosen it, finds his studies arranged upon a logical plan. A system of perfectly free election can be satisfactory only where much good influence is brought to bear upon the choices of the better students, and where indifference prevails as to the effects upon the poor ones. The group system preserves the essential advantages of the elective system without its serious defects; and its universal

use in the technical and professional schools is, I believe, a chief reason for their much greater efficiency in their fields as compared with that of the colleges in theirs.

This mention of the superior efficiency of the technical schools over the colleges suggests another reason for the difference between them, viz. the former have never lost sight of the educational value of effort and discipline, while the latter too largely ignore them. In our own generation we have witnessed the transformation of the greater American colleges from institutions primarily educational into institutions partly educational and partly social. This change has been linked, naturally enough, with an insidious luxurizing of education, in which process the features of the system disagreeable to young people have been emasculated, the guidance of their studies has been intrusted largely to their own whims, and the responsibility for their learning has been shifted mostly from them over upon their teachers. We are now beginning to reap the natural fruits of this short-sighted policy. Our students as a whole have many hazy impressions but little exact knowledge, are habitually inaccurate in all things even to the three r's, and regard their intellectual duties as subordinate to their personal inclinations.<sup>1</sup> There can be no im-

<sup>1</sup> On these matters the recent addresses and articles of many of the younger college presidents are illuminating. An important document upon the same matters as concerns the schools, is the recent Declaration of Principles of the National Education Association, published in *Science* 28, 1908, 333.

provement in these matters until effort and discipline are restored to their proper educational status. By effort I do not mean a nervous straining imposed from without by fear of the exercise of the teacher's constituted powers, but a calm determination, originating within under the stimulus of the influence and example of a teacher who knows how to inculcate a spirit of Spartan pleasure in devotion to duty with ambition for intellectual endeavor. It cannot be too often or too strongly repeated that in the development of the mind, as of the body, it is through effort that strength is gained and through responsibility that character is formed. Nor should we lose sight of the value of drill, good old-fashioned drill in the elements of knowledge, which provides the only means for doing something with poor students, is a good method for the mediocre ones, and does no harm to the best. Furthermore, we need to restore the understanding that the responsibility for learning rests with the student, not with the teacher. In fact no teacher can educate any student; all that he can do is to show the student how he can educate himself, and perhaps supply him with some incentive to do it. Another phase of the luxurizing of education is found in an exaggeration of the value of pleasingly-presented information, which we can pour out in floods without serious disturbance to our students, as compared with training, which must be self-acquired with effort. Yet training is far more important than information in education, and

for many reasons, — amongst others for this, that the acquisition of information follows easily and naturally upon training, while the reverse is not true. The trained mind assimilates information and transmutes it into knowledge, where the untrained mind can do little more than store it en masse. Every teacher should keep always in mind the great saying of HUXLEY, that “the great end of life is not knowledge but action”; or, if he prefer, he can put the same thought in the words of President ELIOT, “train for power.” In training for power, or action, no subjects are better prepared to render service than the sciences; and towards the development of a more Spartan and less luxurious spirit in education the teaching botanist should lend all of his influence.

Our modern conception of culture involves the idea of the equality of all the great leading departments of knowledge. Most universities and the greater colleges attempt to provide instruction in all departments which are of a character and grade suitable to their students; but some such institutions, and most high schools, cannot afford to do this, and some principle must be followed in determining which ones should be selected. The best principle, however, seems to be obvious. Selection should be so made as to give equal representation to each of those natural groups of subjects which are known to require distinct methods of thought, or to appeal to different types of mind. That subjects fall into such groups is

well known. Thus, aside from the primary division into humanities and sciences, there are minor groups centering about languages and literatures, involving the faculties of expression: about mathematics, involving the faculties concerned with number and spacial relations: about history and geography, involving interrelations of human-ity: about art and music, appealing to the æsthetic faculties: about philosophy, involving the loftiest efforts of the human reason: about the sciences, exercising the inductive faculties and seeking to transfer a replica of nature into the mind of man. These minor groups are likewise subdivided according to lesser differences between them. Now it should be the aim of every educational institution, of whatever sort, to provide equally competent instruction in something, appropriate in grade to the age of its students, from each one of these great leading groups, without cultivating some to the neglect of others; while additional subjects should be introduced with care to secure a symmetrical representation from the different groups and leading sub-groups. Thus only can all students be assured their just right to an equal opportunity for finding and following their main interest, and thus only can they all be given that general knowledge of many things involved in our ideal culture. In these many things, I take it, should include something from each of the great divisions of knowledge. Presently our modern educational trend is this way, as is exemplified in our secondary

college entrance requirements, which not only permit but encourage such a plan.

A few pages earlier I said that the sciences are not so well taught, upon the whole, as the humanities and mathematics, and we can hardly expect for the sciences an educational equality with the older subjects until this deficiency is made good. Some of the causes of the deficiency are innate in the case and beyond our own control. Thus, the luxuriousness of modern education, with its leaning towards avoidance of effort, its permission of inaccuracy, and its tendency to substitute information for training, does not offer a favorable environment for the growth of subjects which, like the sciences, are nothing if not exacting, accurate, and individualistic. Correlated with this is the fact that the sciences, partly because appealing to the rarer reason rather than the commoner emotions, partly because of the defective early training of most students, and partly because of the strenuousness of the laboratory type of study, with its demand for much mechanical manipulation, its fixed hours and methods of work, and its absolute requirement of independent observation, are distasteful to young people, who prefer to absorb their knowledge, as they have been mostly trained to do, in physical ease, by methods which can be lightened by the wits, and from printed books upon which they can lean for authority. For these things the science teacher is not responsible, and cannot himself change. It is fortunate, therefore, that

they are only of minor account in comparison with the main causes of our defective teaching, which are within our control and removable. Thus, the sciences, chiefly on account of their youth as laboratory-taught subjects, have not yet had time to become organized and standardized for their most effectual educational use. To a considerable extent we know what subjects are most worth teaching and how best to present them; but there remains a very broad margin of matters on which opinions and usage are divided, while hosts of topics are in need of careful sifting and testing. But effort, discussion, and time will bring order in all these directions. Again, teachers of the sciences are not as a rule as well trained for their work as are the teachers of the humanities for theirs, and sometimes they are not trained at all; for the status of the sciences is still such in some schools that their teaching is handed over to that member of the staff who is least overworked in other ways, and who is then expected to "work it up" ahead of the class. But conditions in this respect, too, are improving, and the supply of well-prepared teachers is now becoming sufficient to deprive educational boards of the excuse that they cannot be obtained. More important, however, is the fact that our science teaching is suffering from the wide prevalence of a serious fallacy, viz. the belief imposed upon all of their students by the universities, that in order to be a good scientific teacher one must at the same time be an active scientific investigator.

This matter I shall consider again in the third chapter; I only mention it here as one of the removable causes of defective teaching. Finally, in correlation with this fallacy, our teaching suffers from the fact that our teachers tend to rely overmuch on the merits of their subject for success, and neglect or ignore the use of those personal and diplomatic qualities, and those legitimate devices for arousing attention and interest, which are essential to success in dealing with impressionable and self-centered youth. This matter also I shall consider further in the third chapter, but I cite it here as perhaps the most vital of the defects of our science teaching. To the correction of these various defects the science teacher should bend all of his efforts, since upon their correction depends the elevation of his subject to its rightful educational dignity.

Thus much for the place of the sciences in education; we turn now to the educational place of Botany among the sciences. In a broad way the educational value of all the sciences is much the same, or at least, they differ less from one another than all do from other subjects. Those which are recognized in general teaching are Chemistry, Physics, Botany, Zoölogy (with Human Physiology), and Physical Geography (or Physiography), all of which have good standing as high school subjects, Astronomy and Geology which are rarely found in high schools and belong distinctly in college, and the newer sciences of Experimental Psychology and Anthropology, which belong



exclusively in college. These sciences segregate somewhat according to the method of their study. Thus Botany and Zoölogy are chiefly observational in method, and are extremely alike in most of their features; Chemistry and Physics, though resembling one another less in their subject-matter, are alike in being primarily experimental in method; while Physical Geography is characterized by the prominence of visualization and generalization. This natural grouping of these sciences suggests the practical advantage that schools which cannot afford to provide them all had better provide one from each group rather than two in the same group; and all considerations of educational expediency indorse this plan. As to expense of equipment, Chemistry and Physics are much alike and both are more expensive than the others; Botany and Zoölogy are about alike and less expensive than the two former, but more expensive than Physical Geography.

The group of recognized high school sciences thus includes five, and the question naturally arises how these are to be adjusted in the curriculum of the four years of the course. The difficulty is further increased by the fact that the first year in high school is generally considered too early for the serious study of any subject as a science. In practice the greatest diversity prevails,<sup>1</sup> and so much

<sup>1</sup> A careful statistical study of this subject by G. W. HUNTER is contained in *School Science and Mathematics*, 10, 1910, 1. A new plan now in trial at Springfield, Massachusetts, places in the first year of the high school an experimental course upon topics from the various sciences.

must depend upon local conditions that it is difficult to make any general recommendations. In some places the Botany and Zoölogy are combined into a single year of Biology, with no additional instruction in those subjects. This method has the serious demerit of yielding a very defective knowledge content for both sciences. In any subject there is a point up to which, while the training is all valuable, the knowledge acquired is relatively small; and it is, I believe, the common experience that knowledge in these sciences follows in proportionally greater amount in the latter part of the year. I think, therefore, that a full year of either Botany or Zoölogy is of much more value than the combination half year of each. In some cases where the course in Biology is used, provision is made for a full elective year later in either Botany or Zoölogy, and such a plan fully meets this objection.

As to the two sister sciences of Botany and Zoölogy, they are so very similar in every educational feature that a choice between them must be based chiefly upon the predilections of the teacher, some conditions of local expediency, or other extrinsic cause. So far as training is concerned it matters not in the least whether one studies the sedentary and food-making plants or the locomotive and food-destroying animals, for these differences are insignificant as compared with the resemblances between them as living organisms. Zoölogy has some advantages; the structure of animals is far more sharply differentiated than

that of plants, and throws great light upon the structure of man, hence affording the best basis for the understanding of many of the facts of human physiology, hygiene, etc. On the other hand, experimental physiology is far more practicable in plants, many of whose most important processes are physiologically identical with those of animals, while plants are easier than animals to obtain and keep. Botany, perhaps, comes somewhat closer to our daily interests than Zoölogy, and æsthetically it certainly far exceeds the latter.<sup>1</sup> Most people undoubtedly consider Botany a much easier subject than Zoölogy, but that is due entirely to the fact that hitherto only its more superficial aspects have usually been selected for study, though this is changing so rapidly that already the two sciences rank as equals in this feature.

Such are the views to which one student at least has been led as to the place of our science in the general system of education. Whether the reader agrees or not is of no great moment, but it is indispensable that he have knowledge and opinions of his own on these matters of fundamental concern.

<sup>1</sup> If the reader desires an analysis of the advantages and pleasures of botanical study, he can find a very full and clear treatment of the subject, with many citations of the literature, by F. E. LLOYD in LLOYD and BIGELOW'S book, *The Teaching of Biology in the Secondary School*. This book, in fact, is particularly strong in its citation of the literature of other phases of botanical education as well.

## II. ON THE QUESTION: WHAT BOTANY IS OF MOST EDUCATIONAL WORTH?

THE remarkable expansion of botanical science in recent years has immensely enriched our knowledge of plants in every direction, while at the same time it has caused a segregation of the science into rather sharply-marked divisions. So far as investigation for the attainment of new knowledge is concerned, no one of these divisions is any more important than another, for all are of the utmost value and boundless in every direction. But in teaching, in general courses, selection is imperative, and it is necessary to determine what parts of the science will yield richest returns for the time and effort expended. The practical phases of the subject are treated elsewhere in this book; I shall try here to examine what data there may be for a judgment upon the relative educational value, from our present point of view, of the different divisions or phases of botanical study.

We may note at the outset that any such inquiry must involve the idea of the formulation of some kind of optimum course such as will represent the harmonic resultant between the various factors involved. In this case the factors are mainly these: the present state of knowledge of the science, our present command of the technique of laboratory administration, and the psychological make-up of the adolescent mind. It seems to me that, from the nature

of the case, such an optimum course ought to exist and be discoverable through discussion, trial, and experience. When found, it would offer a standard framework equally applicable wherever Botany is taught, though it should always allow a margin for the play of the individuality of the teacher, and for adaptation to legitimate local conditions.

It may seem at first sight that the formulation of any such optimum and standard course would be well-nigh impossible because of hopeless difference of opinion as to what should constitute its content. It is true that the greatest obstacle to its formulation rests in the difference of opinion amongst authorities as to what should enter into its construction. Where, however, opinions are convictions founded on the study of evidence, only full discussion, based upon experience, is necessary to bring about a substantial agreement. But it is a fact that most of our supposed opinions are only predilections based on some unconscious prejudice given us by early surroundings or education, and are no more matters of conviction than is the language we speak or the town that we live in. By constant meditation upon the excellences of those phases of the science which he likes most, usually those in which he has been best educated, one becomes impressed by their great, and very real, value for training and as knowledge; and in the absence of constant comparison with other phases, and of discussion with per-

sons of other interests, one's own naturally comes to seem most important of all. It is, then, particularly important in this discussion to endeavor to put aside prejudices based upon the nature of our own education and occupation, and to attempt to rise to a standpoint high enough to give a view over the entire subject. Happily, this is becoming easier with each succeeding generation of teachers, to whom our best colleges are now giving a measurably thorough and well-rounded botanical education.

As to the desirability of an optimum or standard course, two considerations affirm it. In the first place, both reason and experience point to the need for some authoritative and widely-accepted standard, or measure of value, by which teachers can estimate their own courses, towards which those forced to work under unfavorable conditions can strive to approximate, and to which all can point as authority in support of their efforts to secure better conditions and equipment from those in control of educational policy and expenditure. In the second place, there is a reason of great practical importance connected with the peculiar relations existing between the large preparatory schools and the great colleges, especially in the eastern United States, — namely, since the schools prepare students for many different colleges, and since the colleges draw students from many different schools, there must obviously be much confusion and waste of educational effort unless the schools can prepare on one set of specifications (*i.e.* a standard course)

for all colleges, and unless all colleges will accept preparation upon one set of specifications. Yet in the past the colleges, placed by circumstances in a position to act the tyrant if they chose, have largely made their requirements each for itself, thus entailing an intolerable burden upon the schools; and all the efforts of special committees and boards did not suffice to remove this difficulty until the foundation of the College Entrance Examination Board, whose influence for good in this direction has already been great and gives promise of finally removing the trouble altogether. Now the central principle of this Board consists in the provision of standard courses which all schools can offer in the assurance that they will be accepted by all colleges, and the Board's standard course in Botany, with other related matter, is printed in the Appendix to this book.<sup>1</sup>

We turn now to consider the desirable content of the optimum course. However much we may differ in details, all teachers will agree upon this, — that the optimum

<sup>1</sup> The College Entrance Examination Board, although an independent organization, is controlled by a Committee made up of officially-appointed representatives from universities and colleges in the eastern states, (all of which now accept its work,) and from a number of the leading secondary schools. It publishes full specifications of courses, drawn up in the different subjects by authoritative committees from representative associations, and holds examinations thereon every June in all the large centers in the United States and in some foreign countries. Its work is of course more important in the East, where the schools and colleges are wholly independent of one another and largely independent of any geographical segregation, than in the West, where the State Universities have complete control over the courses given by the schools, and where

botanical course is that which combines the best scientific training with the most useful knowledge of plants. Our inquiry then resolves itself into these two questions: What phases of Botany best develop the scientific powers? What knowledge of plants is most useful to the average man?

A study of the ways in which intellectual results are won in science, as indeed in most fields of practical endeavor as well, shows that there is but one scientific method, and that is made up of three coöperating elements, viz. *first*, exact observation of things as they are; *second*, critical comparison of the results thereof; and *third*, logical testing of the derived conclusions. Each by itself is of small value, but yoked together they form the invincible phalanx by which man is enabled to force his advances into the stubborn unknown.

Of all scientific powers, then, the foremost is that of exact observation, and therefore the cultivation of observation should constitute the first care of any course. Observation, however, does not consist, scientifically at least, in

the vast majority of students attending college in any given state go to their State University. If the reader desires any further information concerning the work, personnel, publications, etc. of the Board, he can obtain it on application to the Secretary, address Sub-Station 84, New York City.

This Board is but one element in a strong movement towards standardization of the framework of education in this country. Other important contributions thereto are contained in an address by E. E. BROWN, in *Science* 30, 1909, 417, and in a Report of a special committee in the same journal, 590.



a habit of taking note of everything existing or occurring around one. Indeed, some of the best scientific observers can be most oblivious of the details of their surroundings. But it consists in a power of concentrating the eye and attention at will upon any desired object and seeing therein all that it contains of fact and relation. It is an aggressive power which can at will be roused to militant action and thrown against a problem, though at other times it may remain passive or latent. It is, moreover, a wholly subjective activity, non-existent outside of the observer, to which the object observed remains deadly indifferent. This is always a surprise to young students, who expect each point of importance to call attention to itself by some suitable method, something like showing a tiny red light or sounding a little bell; and they learn only slowly that the gains from observation must always be wrested from a silent and sullen enemy.

For training in observation there is certainly nothing so good as the study of structure, the actual fact-features independent of explanation, exhibited by plants. Moreover, in order to permit of the undisturbed concentration of eye, mind, and hand upon the work, uncomplicated by distractions introduced by the use of unfamiliar methods or tools, the first laboratory studies should be centered upon objects of clearly defined characters, already somewhat familiar and large enough not to require special instruments. Answering to these demands there is certainly

nothing better than the structure of the familiar flowering plants. In this respect the older type of botanical instruction which prevailed into the present generation, that which rested almost wholly upon the structure of the flowering plants, was particularly strong, and I doubt if we shall ever find a more logical or a better practical starting point and axis for botanical courses than it offered. Whether we begin, as did ASA GRAY, with a study of germinating seedlings, or, as seems very practicable, with a study of leaves and their work, or, as is commonly done in these days, with a study of seeds, does not matter particularly, the main point lying in the use at first of large and more or less familiar materials. Later, when special instruments are introduced, the various phases of microscopic structure become available, and they are equally good for observational training. In general, therefore, plant structure, on the lines of the older type of instruction, forms the best beginning and axis for any course.

Second among the scientific powers comes that for critical comparison, involving correlation and generalization. It comprises training in ability to compare a series of variable structures with a view to eliminating the variable and unimportant, and to distinguishing the constant and important. In another phase it includes a power to trace back, through a series of stages, differing forms to a common origin or similar forms to their different origins, as the case may be. In Biology the chief field for the exercise

of this power, so valuable in many other fields as well, lies in the study of Morphology; and, for development of the morphological instinct, well-nigh ideal materials are offered by the manifold modifications and metamorphoses of the members of the higher plants. It is true, the morphological transitions from group to group in the study of the plant kingdom are not inferior, except in regard to practical difficulties of manipulation. The study of the morphology of the parts of the higher plants as formerly treated was, however, injured by the introduction of certain formalistic conceptions, against which I give warning in the ninth chapter of this book; but viewed in the more objective light thrown by modern studies, this morphology of the higher plants forms an invaluable element in any botanical course. Equally good material is offered also by modern studies in internal morphology, through anatomy; but, here again, practical difficulties in the study give a strong advantage to external morphology.

Third among scientific powers comes that for logically testing the truth or falsity of probabilities suggested by the results of observation and comparison. For training in this power our science offers admirable means in physiological experimenting. If suitably linked to observation of the great leading facts of structure and morphology in correlation with habits, and used as a test of conclusions suggested by reasoning thereon, and if conducted, as it should be, under rigidly controlled conditions, it is a dis-

cipline of the first value. Now it is an actual fact that physiological experimentation is most practicable upon large plants,—the common large and familiar forms which in general are the same as we use for the study of morphology and structure.

So far as concerns scientific training, therefore, I conclude that the best material offered by the science consists in the structure, morphology, and experimental physiology of the higher plants.

There are teachers who do not agree that it is best to begin a general course in Botany with the study of the familiar higher plants, but who prefer some other plan, usually the study of the plants by groups, beginning with the lower forms. With some teachers this is an opinion formed on the basis of experience. With others it represents a plan which appeals to them as embodying the best theory, although they usually abandon it after some trial. With still others, including some younger teachers, I have sometimes fancied that it arose rather from the innate desire we all have to be a little different from others, or to lead a change from the old ways. This spirit is part of a deep-seated characteristic of living beings, the basis, I have no doubt, of unceasing variation in organisms, of fluctuation of fashions among people, and of the feeling which made the Athenians grow tired of hearing Aristides called *The Just*. This feeling can easily become a source of error in judgment, and the young teacher should make

sure that his opposition to older courses, and his preference for something new, is not simply a manifestation thereof.

We turn next to ask what Botany is of most worth as knowledge to the average man of education. An elementary course must take careful account of this, since the great majority of students go no further in the subject, and the course must be made complete in itself for them, as well as a foundation for those who continue into higher work. The most important knowledge, I should say, is that which, when a man looks upon the world of plants, enables him to know those facts about them which are most fundamental, wide-reaching, and illuminating. His knowledge must, therefore, include an acquaintance with the main facts as to what they are made of and their architectural construction: what they are doing in their daily lives, and how these lives are interwoven with those of animals: why they have the shapes and colors and sizes and other notable peculiarities they exhibit: what different kinds of them there are, and how they have evolved from lower to higher groups.

To make a course valuable for knowledge content as well as for training, therefore, it must involve some personal acquaintance by the student with the cellular structure of plants, — what cells are like, and what are the appearance and characteristics of that all-essential protoplasm of which every person of education hears much, and in what ways the tissues build up the great plant structures,

so strikingly adaptive to many and diverse external conditions. Incidentally, also, this study will remove all mystery from the microscope, and make him know the real nature and value of this principal tool of biological research, — one of the greatest of all the tools that man has developed. The general botanical course must, therefore, include some microscopical work upon cells and tissues. It cannot include enough to give any thorough knowledge in detail, it is true, but it can go far enough to open up this important subject and give some accurate first-hand knowledge of what it is all about, which is as much as can be expected in a general course.

The second kind of illuminating knowledge concerns the daily life of plants. Therefore, it should include some acquaintance, based upon experiment, with the great leading processes, — photosynthesis, a knowledge of which is indispensable to an understanding of the real place of plants in nature and of their relations to animals: assimilation, with its explanation of the need for minerals, fertilizers, etc.: respiration, with its important economic connections: modes of absorption, transport and elimination of substances: growth and its nature: reproduction, with its processes and significance: and the method by which plants adjust themselves, through their irritability, to their immediate surroundings. A general course, therefore, should include a study of these primary physiological pro-

cesses. Such study has a further value in this: that as most of these processes are physically, chemically, and biologically identical with the corresponding processes in animals, while far simpler and more practicable for study, the students' knowledge is thus doubly extended.

The third kind of illuminating knowledge is concerned with the explanations of the shapes, sizes, colors, and peculiarities of form exhibited by plants. This study we call ecology. It is as yet a somewhat nebulous subject, with a larger accumulation of fact matter than we can see the significance of, reminding one somewhat of a highly saturated solution which has not yet managed to crystallize, but which will do so when a suitable nucleus is presented. Nevertheless, we do really know much of importance upon the matters ecology represents; and some instruction therein, even though largely theoretical, is certainly important.

The fourth kind of illuminating knowledge about plants concerns the different kinds, with the ways they live and their connections with one another. This, like the other phases of botany, is endless; and only enough can be considered to show the general natural history of the principal groups in the plant kingdom. The student who has had a general course need not know many Algæ, but he should know what Algæ are, their most striking divisions, the ways in which they make their living and reproduce, and the fact that they have formed the starting

point for the evolution of the other groups. He cannot know many Fungi, but he should know what Fungi are, how they are nourished, and what is the nature of the damage they do to man's health and his crops; and he should certainly know something about the operation of Bacteria and Yeasts, which so profoundly affect his welfare. In the same way he should know in general the essential characteristics and habits of the Lichens, the Liverworts and Mosses, the Fern Plants and the Seed Plants; and he should have a general knowledge of the remarkable relations existing between these groups.

In general, in this study, acquaintance with larger and more prominent forms is more important than acquaintance with the lower and inconspicuous kinds, for a knowledge of things that can be seen with the naked eye, and are likely to be met with again and again, is more important than a knowledge of things requiring special instruments for their detection, though to this there are many exceptions.

For the sake of its knowledge value, therefore, no general course can afford to confine itself to that structure, morphology, and physiology of the higher plants which afford the best of material for training; but it should include a study of cellular structure, physiology considered as knowledge, the elements of ecology, and some treatment of structure and habits of plants from all the great leading groups. It may seem at first sight



impossible to include so much within the compass of a general course and do it well. But in fact it can be done, and is done. The possibility thereof rests partly upon the increased skill and facilities which have become available in recent years, partly upon a rigid selection of the more important and illuminating matters for treatment, and partly upon the combination of the topics in such a way as to make them throw light upon one another. Nowhere, probably, is any attempt now made to treat these various constituents of the course separately, but they are always welded together in one way or another. The commonest method appears to be that in which the course is divided into two parts. The first part is based upon the study of the higher plants as followed through their cycle of development in typical examples, the structure, morphology, physiology, and ecology of each leading organ being considered in order. The second part consists of a study of the natural history of the groups of plants, a subject which, with the knowledge acquired in the first part, the student works through with a facility and understanding which he could not command if this work formed the beginning of his instruction. Such a course is essentially synthetic. It is the kind which is most prominent in botanical education at the present time. It is represented in the recommendations in this book, is embodied in the outlines in Part II, is followed in substantially all of the prominent recent text-books, is

used in innumerable schools and colleges, is adopted in the important option, or unit course, used by the College Entrance Examination Board, and is accepted in the unit recently formulated by the teachers of the Middle West.

Among the phases of botanical study which ought, because of their knowledge value, to be introduced into a general course, there is one which I have reserved for special discussion, viz. that contributing to an understanding of agriculture, horticulture, and other economic matters. We are witnessing at this day a remarkable awakening of interest in this phase of botanical education, especially in the Middle West. In the minds of many persons who make the demand for the introduction of such knowledge, it means the addition of formal instruction in these subjects, even to the exclusion of some of the more scientific phases if necessary, and it reflects the same short-sighted spirit which would make all education "practical." But in the minds of the teachers of the Middle West, who have taken up the subject with much energy (as their new unit course in Botany, printed in the Appendix to this book, sufficiently testifies), it has a very different, and a thoroughly educational, meaning. It is yet too early to say in what way this knowledge can best be managed in our courses, for at present the wholly unformulated for practical administrative vast amount of study and experiment will be

needed before we can introduce it into our botanical courses without doing them more injury than good. It seems to me wholly unlikely that formal instruction in economic topics can ever be made profitable in a general botanical course, nor indeed do I think it is the best way to attain the desired end. Aside from the question of time, most schools have neither the equipment nor the environment to make such work profitable, for it must be studied practically to be of any real use. But in addition to this, the study of economic matters, from the nature of the case, does not seem to be, like morphology, physiology, and natural history of groups, a separate discipline, but rather is an extension of those subjects into the economic field. The most thorough knowledge of economic subjects must surely be that which arises from an understanding of the fundamental scientific facts or phenomena upon which they depend. Hence the most logical plan for the study of economics would seem to be this,—to study the scientific facts of structure, physiology, etc., primarily in a scientific way, and then, whenever a subject is met with which underlies or explains some important process in agriculture or the arts, the economic matter should be carefully treated in the light thrown by science upon it. It is characteristic of all the modern and successful scientific study of agriculture, horticulture, and other economic subjects, that the economic phases are grounded first in thorough scientific investigation of

the conditions concerned, and this is the principle upon which all of the very successful work of the Department of Agriculture is being done. To begin with economics and work back to the scientific basis thereof seems to me justified neither by theory nor experience, while beginning with scientific study and working thence to economics seems to me in accord with both. Of course this method has been to a considerable extent used by all teachers in their regular work, and I have myself often noted the interest taken by students in economic subjects thus presented. But there is no doubt that our courses should give more careful and systematic attention than heretofore to these matters. Whenever the work of students can thus be linked with the important affairs of practical life, it is an immense advantage, both as making them more truly educated persons, and as giving them a better understanding of, and interest in, their work.

From this discussion of the broad subject of the value of the different phases of Botany in a general course we turn to consider certain special matters of which the worth is still more or less in debate. Of these the first in importance concerns the study of the classification of the higher plants, with their identification by use of Manuals, and the naturally-associated herbarium-making. As everybody knows, a quarter of a century ago this was a large part, sometimes almost the exclusive whole, of real botanical instruction, and it still lingers in places

though often in only a rudimentary or perfunctory state. Moreover, it is very generally omitted altogether from our present botanical courses. The omission, I believe, is partly administrative and partly educational. The indispensability of field study for such work, in face of the extreme difficulties (presently to be mentioned more fully) which field study has to meet in the largest of our schools, almost prohibits it in the majority of places. Educationally it certainly gave a training of the highest character in observation, comparison, and description; but in these respects it had no superiority to the subjects now in our courses, supposing the teaching to be equally good. In knowledge value, however, the identification work was limited and special, and in this feature it was, for the great majority of general students and especially for dwellers in cities, inferior to that yielded by our present courses, which, whatever their other defects, certainly illuminate somewhat widely the world of plants and animals. Theoretically it seems an admirable plan to teach every student how to identify the common plants around him, and to give him some good start in doing it; but in fact, as we all know, extremely few ever continued the work beyond the course. On the other hand, the identification work had one marked superiority over our present courses; namely, it gave to those who did continue it a healthful interest which they could follow as an absorbing recreation in after life. Moreover, a knowl-

edge of the names and classification of plants, and an ability to use Manuals for their identification, is indispensable to those who engage professionally in botanical work, especially teaching. These facts taken together appear to show the proper place for identification work. It should not be made a part of the required work for all students, but should be opened to those who have a taste or a need therefor. Its value and interest should be presented strongly to all students in general courses, and then, by means of voluntary or special divisions, some training in the use of Manuals, with related matters including herbarium-making, should be given. Colleges, of course, ought to offer elective courses therein, with attention to nomenclature and taxonomic methods. The subject is one which can be studied, to a much greater degree than most others, by one's self; and it forms very suitable work for the summer vacations which it will help to utilize. Arrangements should be made to count good field work of this kind in the student's schedule of study. No person preparing for advanced botanical teaching should be certified as competent without some such training.

There is another reason why identification is a less appropriate part of a general course than it used to be, and that is found in the character of our Manuals themselves. The extreme refinement of modern systematic study has resulted in the discovery that our old visible, or Linnæan, species are really aggregates of minor or

elementary species. In many groups the number of species, distinguished, however, for the most part by marks which none but an expert can recognize, has been increased manifold, and no doubt an equally critical study of other groups will yield similar results. In consequence our Manuals are becoming usable only by expert botanists, and the ordinary student cannot take any satisfaction in them. Of course these elementary species are real entities, at least for the most part, and must be suitably recorded in appropriate works. But I agree with several botanists who have said that for educational purposes we must have manuals which describe only the old Linnæan species, those classification units which are recognizable without the service of experts, while the treatment of the elementary species should be relegated to monographs or other technical works. Moreover, these Manuals themselves will be far more useful and attractive if they include information upon other striking facts, — morphological, ecological, economic, historical, — connected with the respective species.

The second matter needing some discussion in this connection is the place and importance of field work. That field excursions should be taken as often as possible, even into parks and botanical gardens when no wild region is available, I think all teachers will agree; and certainly that is my opinion. Nevertheless I think that field excursions must, for practical reasons, always remain

for most schools a very minor element in their instruction; while, furthermore, I am of opinion that they are not so indispensable to a good course as is sometimes maintained. In the majority of schools field excursions involve great administrative difficulties in the securing of sufficient time therefor, in access to suitable localities, and in the discipline of full-spirited youth. Furthermore, only small numbers can profitably be allowed on field trips (a subject on which I comment elsewhere), while most teachers have to deal with very large numbers; and besides, in the arrangement of the American school and college year the field material is available only for a little while in spring and autumn. On the other hand, in well-organized laboratories commanding a sufficiency of living material, students can be managed and taught in the large groups which are an essential feature of this problem. Even if field excursions were just as practicable administratively as laboratory work, I do not believe that they ought to form a substitute for any great part of the latter.<sup>1</sup> I believe it is found by those who conduct much field work that this is something which looks better in theory than it works in practice, and that the results are meager in

<sup>1</sup> If the reader wishes to learn the most that can be said in favor of field work, with, incidentally, the most that can be said against the present laboratory courses, he will find both in an article by C. F. HODGE in the *Nature-Study Review* for September, 1908. With this he may wish to compare my answer upon both points in the same journal for November, 1908.



amount in proportion to the effort expended. But, however meager in quantity, the results are very precious in quality, for they serve to link, through the bond of personal experience, the necessarily somewhat artificial or conventional work of the laboratory with the realities of nature in the large. It is in this linking of laboratory with nature, rather than in any knowledge which it imparts in itself, that the chief value of field work must consist for most students under the conditions prevailing in our modern schools and colleges. The teacher will therefore do well to plan for his field work from this point of view.

The substance of this whole matter is, after all, nothing other than this, that botanical education under modern conditions is as much an administrative as an educational problem. Laboratory courses are administrable; those requiring much field work are not. Good generalship requires, therefore, that we direct our efforts towards making our laboratory courses just as valuable in themselves as possible. This is to be done by developing all possible devices of natural gardens, greenhouses, aquaria, museums, pictures, and other illustrations which can serve to make our laboratories represent nature as nearly as possible, by occasional excursions, the oftener the better, and by especial attention to the matters which laboratory and class room are particularly fitted to teach, — namely, the fruits of the accumulated botanical knowledge of the race, especially in relation to man's interests.

## REQUIREMENTS AND TRAITS OF THE COLLEGE BOTANICAL TEACHER

The requirements for good botanical teaching the world over are by far the same. Ideally he is a person of natural capacity born for this work, and furnished with the best obtainable botanical education. The success of the person is largely dependent upon the attractiveness of the profession, and the more attractive we can make botanical teaching the better the quality of the persons who will enter it. A good botanical education can be acquired.

The best basis for a botanical education is derived from the college course in which especial attention is paid not only to Botany as a science, but also to its teaching. It is "back" because here, as elsewhere, the best education is that derived from actual experience and effort for which, however, the college course affords the best foundation. It is well to remember that here, as elsewhere, it pays to have the best. Without doubt the future teachers of Botany, in high school as well as college, will be college trained, and indeed there are indications that such training is to be made a requirement in the more progressive States. If the teacher can have in addition a year or more of graduate work it will be an immense advantage, especially for the possibility it gives of first hand experience with investigation under a

competent teacher. It is of course true that not many high schools can employ teachers of Botany alone, but the tendency to employ teachers who can teach Botany as one of a limited group of closely related subjects is on the increase.

But while a college course followed by some work in a university affords the best existent preparation for botanical teaching, it is not at all ideal. For one thing the universities, and to a lesser degree the colleges (which are strongly influenced by them), lay an emphasis upon investigation out of all proportion to its importance to teachers, and even to an extent of actual injury to them, — a matter of which I shall speak later. But another and more serious fault is this, that the teacher receives no instruction in some matters very essential for him to know. Thus, he can take many elaborate courses without having the opportunity, or at least without being required, to know the common facts about the commonest plants around him, being sometimes unable to identify the plants of his native flora. Again, he may know nothing more of the historical or biographical phases of the science than he may have picked up incidentally, although for teaching purposes such knowledge is vastly important, not only for the favorable background it offers for the projection of present-day knowledge, but also for the purpose of placing at the disposal of the teacher the dramatic, heroic, and humanistic aspects of the science. Again, he is usually taught nothing of the tech-

nique of laboratory administration, as to laboratory construction, furniture, apparatus, supplies, and manipulation. Again, he is allowed to take up the instruction of young people without the slightest knowledge of the results, very valuable all imperfect though they are, which have been won in the scientific study of the psychology of the adolescent mind. Nor does he receive any education at all in the exposition or interpretation of scientific knowledge. Yet these are all matters in which the teacher needs training far more, as a rule, than he does in investigation. They will receive due attention without doubt in the future, and will be certified by appropriate titles or degrees, as this matter of training of science teachers becomes better organized and standardized. Meantime there is nothing for the teacher to do but to work up these matters for himself.

Next in value to college and university training comes attendance at summer schools, which several of the principal universities, and some scientific institutions, maintain in the vacations for those who cannot attend the winter sessions. The obvious objection to these, that they impose hard work at a time when the teacher should be resting, is not so great as it seems. The change in occupation, surroundings, and companions brings so much relief in itself that the work is less trying; and besides, if the learner's spirit is of the right sort, and the teaching is of the true quality, the pleasure of it all should

go far to lighten the labor. In my own experience, too, I have found that there is more rest in change of occupation than in absence of it. Perhaps the mind is in this like the soil, that it does not need to lie fallow, but can continue to bear without exhaustion if given a wise rotation of crops.

The greatest of all summer schools in this country is one which is at the same time a college course, — the summer quarter of the University of Chicago. But so many of our universities now maintain efficient summer schools that the teacher can in all probability learn of a good one by application to the nearest large institution. Of important and distinctive character among such schools are the summer courses of the marine biological laboratories, which, situated upon seacoasts, provide well-nigh ideal physical conditions for summer work. They offer, moreover, as a rule, excellent courses of instruction, the best of material facilities, opportunity to work with a flora otherwise inaccessible to most teachers, the chance for contact with eminent specialists and for acquaintance with other workers of congenial tastes, and in general a scientific atmosphere which is worth at least as much to the teacher as the instruction itself. The best known of these laboratories are: The Marine Biological Laboratory, at Woods Hole, Massachusetts, maintained by the coöperation of many colleges and universities: the Laboratory of the Brooklyn Institute of

Arts and Sciences at Cold Spring Harbor, Long Island: that of Tufts College at Harpswell, Maine; that of Leland Stanford University at Pacific Grove, California: that of the University of California at La Jolla, California: that of the University of Washington at Friday Harbor, Washington: and that of the University of Minnesota at Port Renfrew, British Columbia. In addition there are several lakeside laboratories in different parts of the country. All of these laboratories, like the summer schools of the universities, publish descriptive announcements which may be had upon application.

This mention of summer courses suggests the advantages to the teacher of attending when possible the great scientific conventions of the country, which are held under the auspices of the American Association for the Advancement of Science every year in the Christmas vacation, sometimes in one great city and sometimes in another. These meetings are all open to everybody, and, despite the very technical character of much of their proceedings, and despite also the rather inefficient management of most of them, contain many features of the greatest value to all botanists, inclusive of the opportunity to see, hear, and meet the leaders in the science.

If the teacher is so placed that he has not behind him any adequate training under competent teachers, and yet is determined or obliged to work up some phases of the subject for himself, he can do something by aid of

books. But he should seek first to obtain the advice of some specialist in his proposed work, and guidance if possible during its progress. Knowledge obtained without such guidance is sure to be full of gaps and bad in its proportions. Correspondence courses are not at all prominent in botanical instruction in this country, but would be useful if well conducted, though a very poor substitute indeed, especially in the sciences, for contact with a skilled teacher. No doubt books could, and in time will, be prepared as guides for those who must study alone; but at present very few exist.<sup>1</sup> Much good may be derived from reading, but only as supplementary to the actual study of botanical objects, never as a substitute for it. In another part of this work (Chapter VIII) will be found further suggestions upon reading, and lists of the best existent books.

Whenever advice is needed about books or any other botanical matters, the teacher should not hesitate to write to some botanical specialist, as, for example, the Professor of Botany at the nearest large university. Most specialists take pleasure in assisting any earnest inquirer, and many of them welcome this method of extending their own usefulness as teachers.

<sup>1</sup> STRASBURGER'S *Handbook of Practical Botany* could thus be used, and with great profit, in plant anatomy; and BAILEY'S *Lessons with Plants* would form a good guide for such study in general elementary work. For physiology I have tried to arrange my own *Laboratory Course in Plant Physiology*, Second Edition, so as to make it useful in this way.

There is one feature of the education of the teaching botanist so prominent as to deserve particular discussion, viz. the performance of some work in original investigation. Good scientific teaching consists above all things in the inculcation of this very spirit of investigation, — the instinct to attack new problems with an expectation of solving them by one's own efforts, — and it is a spirit which is not confined to the universities but in principle applies to all grades from the kindergarten upward. Only that teacher who has felt this spirit can impart it. The college graduate, if he has been well taught, has experienced it, for the best undergraduate training involves much thereof, though the investigation must, of course, be of a subjective and not of an objective sort. But in any case it is a great advantage for the teacher to have had a year or two of graduate instruction involving some real, or objective, investigation under a competent leader. In the great majority of cases, however, the teacher in college or high school cannot advantageously continue to carry on the university type of investigation along with his teaching. For one thing he is engaged not with an understanding that he is to be free to do this, but rather with the assumption that he is to give his principal strength to his teaching, which is to be in the nature of reciprocal and temperamental requirement. Moreover, the temper and temperament required for general teaching are not suitable for original investigation.



somewhat antagonistic. If the teacher can do good investigation under these conditions, it is well; but very few can, and the effort to do it injures the work and the happiness of many a teacher. This all applies to the university type of abstract research, the kind which is on the forefront of advancing knowledge; on the other hand it does not apply to some other types of investigation, which are closely and logically connected with the teaching. Of this kind is investigation into the pressing educational problems of the science, a field as difficult and serviceable as anything which the abstract phases of the science have to offer the teacher. Our science courses are still very imperfectly adapted to their constituencies, and we need a study of the reasons and remedies therefor. We have great need for a discovery of better ways of presenting and demonstrating important matters, for more effective and simpler experiments, for more illustrative methods and materials. Again, the extreme specialization of modern science, and the consequent inaccessibility of most of its new results to general users of knowledge, makes vastly valuable the preparation and publication of such expositions of important botanical subjects as combine literary excellence, pedagogical force, and scientific accuracy; and the teacher who does this work well comes very close to the investigator. The community needs not only the discoverers of new knowledge, whose best environment is the university,

but also the interpreters of knowledge, whose natural environment is the college. Again, there is a great field for original study in the investigation of local floras from the natural history standpoint. The construction of a local flora in which the plants are not simply listed but also described ecologically, while the whole subject is presented in attractive literary form, would not only realize for the teacher the real value of abstract investigation, but it would constitute a work of marked scientific value, while fitting perfectly with the work of teaching.

Another great advantage of investigation by the teacher is this, that it permits him to teach by example, which here, as elsewhere, is better than precept. He should, of course, keep his students in touch with his work, and allow them the benefit of seeing him like themselves ever striving to learn and advance. Not only does such study add greatly to the teacher's influence and power, but it adds intensely to the interest of his life and profession. The perennial freshness which accompanies constant progress goes far to counterbalance that monotony of yearly repetition which is the greatest drawback to the life of the teacher.

But, after all, investigation is subsidiary in the work of any teacher. It is the spirit of investigation which is important rather than the results, which indeed can be won quickly and easily by the experts trained and at work in the universities. There are many teachers who do none of it, and many others who

would find their happiness and their usefulness alike augmented if they were to abandon the attempt to combine the two. I make this statement with some emphasis, because at the present time the universities are giving to investigation a prominence which, wholly correct for those who are to remain in university work, is inappropriate or even injurious to the work of those who engage in college or high school teaching.<sup>1</sup>

A thorough botanical education stands so far above all other needs for good botanical teaching that any consideration of the cultivation of special qualities seems hardly to belong in the same discussion. There are, however, qualities which may be cultivated to great profit, and these it will be worth while to consider in brief.

First, what are the personal characteristics of the good teacher? He is, for his part, a liberal but firm leader, finding pleasure in the guidance of young people to more spacious realms of power and knowledge, though he can also serve his turn as a driver when that may be needful. He has in him much of the spirit of the missionary, though he is better without that of the martyr. He is to his students a comprehending and sympathetic friend, ever trying to project his understanding into their state of knowledge and point of view, while, like the wise physician, he makes diag-

<sup>1</sup> The reader who may be interested in a fuller discussion of this, together with other important matters treated in the present chapter, will find it, approached from a somewhat different point of view, in a Presidential address of mine published in *Science*, 31, 1910, 321.

nosis of each individual case and fits to it the suitable treatment. He rates a knowledge of his students as of worth as great as a knowledge of his subject, and he remembers that this subject has no value as an end in itself, but only in so far as it contributes to the happiness and welfare of humanity. He is a genial though uncompromising critic, awarding praise where meet, and blame without bitterness when he must, making all use that nature allows him of humor, but resorting to sarcasm only in extremities. He teaches much through example, and seeks to illustrate the charm of doing as well as of knowing. He utilizes, and turns to profit, the good natural instincts and particular talents of his students, — their pleasure in competition, their ambition to excel, their better emotional moods, and their artistic abilities, while with diplomatic unobtrusiveness he makes use of all reasonable devices for arousing interest and holding attention. He does not avoid discussion with his students, nor fail to learn from them. He respects his profession, views it as a worthy life work, and leaps ever to the defense of its interests. Finally, he refuses to be disheartened by the spaces which yawn between his ideals and his results, but, doing the best that he can and taking no thought for his failures, he presses cheerfully on, profiting by experience and building for the future.

Among these attributes of the good teacher there is one deserving of a little more emphasis, and that is the desire for unremitting progress. The teaching botanist should take a

lesson from his trees, and admit no internal limitation of growth, which should stop only when forced by external conditions. The value of constant progress is the double one of contributing both to his professional usefulness and his personal happiness. Seizing promptly upon every educational opportunity: taking quick advantage of every new opening: keeping closely in touch, through reading new books and the journals, with botanical progress: carrying on his own chosen line of investigation: attending botanical conventions: visiting, as opportunity permits, other botanical institutions: making personal acquaintance with fellow-craftsmen and with the leaders in botanical education: minding his own affairs and leaving the reform of his neighbors' to them: observing closely, judging independently, acting confidently: ever patient, persistent, unhurried: these are the constituents of progress. In truth it is much to expect, and it means hard labor for life; but it is well worth while. "Behind every success is a cross," said a preacher, and he was right.

From the characteristics of the teacher we turn to some of the attributes of his teaching. Of course he seeks above all to give training in the scientific method of thought and work,—in observation, comparison, and experiment, and in skilled coöperation of mind, eye, and hand. He will never allow any temptation to swerve him from the preservation of the scientific quality of his teaching. He will seek also to train his students in self-reliance, so that they shall

always prefer knowledge acquired through their own faculties to that derived from any other source: in admiration for results accurately and logically grounded, with distrust and dislike for the opposite sorts: in faith in causation, and in the conservation of energy and matter: in belief in the supremacy of reason over superstition: in freedom from deception by phrases, no matter how high-sounding: in objectivity of judgment as against anthropomorphism: in intellectual honesty, not only with others, which is easy, but with one's self, which is hard: in industry, which finds pleasure in useful work and does not even shrink from needed drudgery; and he does it all in a way to preserve the natural qualities of spirited and wholesome young people.

While the good teacher will have at command, and habitually use, the approved educational methods for attaining his ends, he should hold himself free at any moment to abandon or contravene them when he can teach better thereby. Pedagogical methods in any case are but relative, those good at one time and place being not so at others; and there may even result a certain relief to all parties concerned through an occasional break in the monotony of good methods by a resort to a bad one. Methods very bad for constant use may be very good for an occasional emergency. Besides, human nature is imperfect and at times it may be wise to meet it with weapons of its own kind. At all events it is in such ready adaptability to emergencies,

in the power to use the best method for the moment regardless of the usual rules of the case, that great generalship consists; and the teacher is a general. Nor even is logic always a safe guide, though it usually is; for there is many a problem of this life unsolvable by the subtleties of logic which is readily met by robust common sense.

There is another attribute of good teaching which cannot receive too much emphasis, and that is the humanistic spirit. Every young teacher should be taught, and should remember, that success in science-teaching, as in so many other vocations, is almost in direct proportion to one's power to influence people. Science is primarily a matter of the reason, but young people are not primarily reasoners; the teacher will, therefore, do well not to trust to the merits of his subject for success, but will give careful attention to those qualities which will increase his hold upon young people. He should cultivate in himself the sympathetic qualities, involving interest in their pursuits: the diplomatic qualities, involving the utilization for good purposes of the peculiarities of human nature in those he has to deal with: and the perfecting qualities, involving attention to the amenities and even the graces of life. He should not permit any weakening of the scientific quality of his teaching, but should aim to present science to his students in a way which conforms to their natures. He should wield the iron hand of the scientific method, but should keep it carefully gloved in the soft velvet of gentle human conduct.

Just here we may appropriately consider a matter which well illustrates this subject, and at the same time is very important in itself. Young people, for the most part, have in them a considerable measure of what may be called a perfecting principle, leading them upon the whole to respect and like those things which are good and clean and dignified, — a feeling which shows itself in their preference for good company, good clothes, and good manners. Now untidiness, dirtiness, boorishness, carelessness, whether showing themselves in the person or manner of the teacher, or in the condition of his laboratory, are a direct affront to this feeling, and always prevent in the student a full respect for the one and an inclination for work carried on in the other. I have sometimes fancied that the alluring character of scientific work leads science teachers as a whole to some neglect of the external formalities and amenities more fully practiced by their colleagues of other subjects; or perhaps the case may fairly be put thus, that the very nature of the subject-matter and methods of the humanities predisposes their teachers to contact with people and to the cultivation of the social qualities, while the subject-matter and method of science predispose one to some personal isolation. Humanity is, from the nature of the subject, a natural practice ground for teachers of the humanities, but not for teachers of the sciences. However that may be, of this I am sure, that we science teachers keep our laboratories in a far less attractive condition than other teachers keep



their class rooms and libraries, while many scientific laboratories are simply disgracefully dirty. Of course the conditions of the case make it harder to keep laboratories attractive, but that is simply another of the extra burdens the teacher of science has to carry. I am of opinion that scientific laboratories, and especially those in which young people make their first acquaintance with scientific matters, should be kept, simply for pedagogical reasons if for no other, in the perfection of neatness. More than this, I think, for the same reason, a laboratory should be made in other ways as positively attractive to the eye and person as possible, all of its construction and furniture being simple, massive, artistic, and all of its objects spaciouly placed and suitably environed. These things are not only desirable for the good personal impression they make upon the students, but are also appropriate because illustrative of scientific method and work at their best.

This mention of simplicity suggests another phase thereof so important as to rank as an educational method, and that is a reduction in number of subjects with occasional concentration upon doing some things the best that one can. In all our education we are doing too many things, being still in the accumulation stage of progress where the effort is made for completeness. We need to pass to the selection stage in which fewer things are taught, but those given a better attention. Because of the prevalent mode of education, our students can carry off many things with a

dash, but they show up very badly when set to do something the best it can be done. The most of them, in fact, do not know what it means to do a thing thoroughly well, their whole early experience having inculcated the standard of doing things just well enough to pass. It is true that the conditions of modern life make it needful for us all to perform most of our duties just well enough to pass, but we ought not to neglect the power to turn at will to some work and do it our maximum best. Moreover, and here is a point I offer my fellow-teachers as an original discovery, although they may have known it all the time, students really like to be made to work in this spirit, perhaps as a phase of the perfecting principle of which I have earlier spoken. They do not like the process at first, but their satisfaction in the obvious worth of the results, and especially their pleasure in the exercise of a power they did not know they possessed, makes them in time like the process itself.

In this same connection I would mention the cultivation of interest. One cannot in science, any more than elsewhere in education, select the interesting parts and ignore the others; but we can make the interesting parts stand out to their best advantage, and can give some tinge of interest to subjects which may even seem to lack it. The good teacher should have something of the same instinct for scientific interest that the good reporter has for news, — a trained knowledge of what matters will interest people

and how best to present them, although I am very far from recommending that the teacher go to such extremes as the reporter. Interest should be cultivated for its worth as a pedagogical method, aside altogether from its diplomatic value; and all legitimate devices of good illustration, — striking artistic effects, suitable events, and congenial activity, — should be used to this end. In full conformity therewith is the principle of selection and individualization of subjects. The human capacity for absorption is limited, and the power of attention is soon dulled by repetition of like things. It is best, therefore, to make use of a few important things in spacious and attractive settings, whether one be concerned with specimens in a museum, plants in a garden, or topics in a course of instruction.<sup>1</sup>

In connection with interest there is one other matter that needs mention; and that is the use by the teacher, for the cultivation thereof, of the humanistically attractive phases of the science, involving materials from scientific history and biography. These are matters which need much wisdom for their successful use, and the young teacher had better introduce them only as he becomes sure of their control. But as he feels he can use them with safety, he can make them invaluable means for effective teaching through appeal to the higher feelings. On the

<sup>1</sup> Some contributions to this subject of the use of interest in teaching are given by C. H. SHAW in *Science*, 28, 1908, 349, and by O. W. CALDWELL in *School Science and Mathematics*, 9, 1909, 581.

other hand, there is one thing which the teacher ought ever carefully to shun, and that is the use of his science to illustrate any preconceived doctrine or dogma. It is said sometimes that a chief object of scientific study should be the inculcation of a love of nature. I do not think so, though this is assuredly a desirable by-product. The object of scientific study is the training of the scientific faculties and the acquisition of a knowledge of natural facts and processes, and many of the greatest and most successful of scientific men have had no love of nature in the sense meant by the users of that phrase. Moreover, any attempt to use natural sciences for any such object is sure to lead into undesirable methods, — into a weak sentimentalism which has blighted much of nature study, into a false poetizing which has served as a cloak for hazy ideas and a release from exacting problems, and into that insincere and mendacious, even though charmingly-presented, literature which has brought upon itself the deserved opprobrium of the name "nature-faking." We are also sometimes told that the study of nature ought to illuminate in clearer light the works of the Creator; but this also, I think, is not so. Those who have searched nature most deeply do not find therein any direct evidence of his working, and whatever of the kind one is to find there must first be read into it beforehand. But the moment one reads into science any preconception whatever, that moment it ceases to be science. If any reader now imagines that the

absence of poetry, sentiment, or religion deprives science of the power to awaken the loftiest of human emotions, I assure him he is mistaken. The experience of scientific men has shown that the exercise of the scientific imagination, especially as it comes for the first time into contact with truth new to the race, yields a pleasure as lofty and uplifting as any which literature, music, or art can offer. More than this, it is, I believe, the same in kind. In all cases the pleasure is in the person, and is felt when some supreme chord in his spirit is touched; and that touch can be given in many different ways.

Finally, as I review this chapter, I think of certain minor matters of which mention ought to be made. A phase of science which the teacher should always keep prominent in his teaching is the exposition of its method, — that is, the exact ways in which, through experiment and otherwise, scientific results have been won.<sup>1</sup> This is a great mystery to most people, and a matter of particular and broadening interest to students, to whom, also, the charm that there is in scientific discovery should be illustrated when possible. Again, in my emphasis upon making all work genuinely scientific in spirit, I do not mean to imply that young students should be obliged to study advanced technical matters, or to study simple

<sup>1</sup> Upon the value of the teaching of the method of science, there is an admirable address by Professor JOHN DEWEY in *Science*, 31, 1910, 121. I am of opinion, however, that the value of fact matter in science courses is somewhat underrated in his argument.

matters in technical ways, but merely that all scientific teaching should be scientific in spirit, no matter what its grade; for the scientific spirit applies just as well to primary as to university work. In cultivating interest, also, the teacher should be careful not to sacrifice this scientific quality. His problem in this matter is not that of giving an adventitious interest to the science, but rather of exhibiting in its best light the interest that the science really contains, and all students who cannot be attracted by a combination of such interest with real scientific quality should be allowed to go. Furthermore, while scientific fact knowledge, won through scientific methods of work, should form the skeleton of the teaching, certainly the teacher should not stop there; on the contrary he should try, from this accurate training as a basis, to lead the students into the broadest and most attractive generalizations and conceptions which their age permits. The former is the particular province of the laboratory, and the latter of the conferences or equivalent exercises in which teacher and students can roam together far afield in imagination. The reader will also observe that I lay much stress upon form, though never, I hope, to the detriment of efficiency. I do not think that the gaining of results is everything in life, and I conceive that success with form is better than success without it. Some emphasis upon the way things are done contributes to the better elements in life, and to a higher civilization.

#### IV. ON THE METHODS AND MARKS OF GOOD BOTANICAL TEACHING

WE come now to consider the practical procedure of botanical teaching in its three cardinal phases of laboratory, class room, and field work.

As to the laboratory work, many teachers have trouble to secure from the authorities a sufficiency of time in the schedule; and in this connection they are often met with the inquiry why much, or most, scientific knowledge cannot be acquired, like other subjects, from the many existent good books. This objection is very readily answered by simply asking the querist in turn, why any person should go abroad for the benefits of foreign travel when so many well-written and beautifully illustrated books exist in description of foreign lands, and much trouble and expense could be spared if one would simply read these beside his own hearth. The parallelism is really very close, and the benefit of personal contact with the foreign places or scientific objects respectively, as contributing to a genuine and more nearly objective acquaintance therewith, is practically identical in the two cases.

The best length for laboratory periods in biological work for general students has been found by experience to be about two hours, that is, two of the usual schedule periods. -Students do not become weary in that time,

and shorter periods are uneconomical on account of the time lost in starting the work and putting things away at its completion. One of the greatest difficulties of teachers in the high schools is to secure these double periods; but they are indispensable for really good work, and the teacher should persist until he gets them. Their status in the counting of hours is commonly this, — that each double period counts the same as a single period with its usual outside preparation. The reader will find that this is the arrangement recommended in both of the standard courses printed in the Appendix to this book.

The number of students in one laboratory division should not exceed, at the most, twenty-five to one teacher, and at times it is difficult to teach even that number with efficiency.

The actual laboratory work is best managed, as most teachers appear to agree, on the *practicum* plan; that is, the students are all working together upon the same problems, and the teacher, after suitable explanations to the class upon starting the work, goes about among the students, giving individual encouragement or criticism. Then, from time to time, as the progress of the work requires, he asks for their attention while he makes suggestions, explanations, or summaries to the class as a whole; and he closes each period by a summary of the work of the day. This plan does not in the least interfere with the independence and value of individual work by the students. Moreover, the efficiency of the work is immensely pro-



moted if outline guides to the study of the particular material in hand, on the general plan of those in Part II of this book, are placed in the hands of each student.

In each new laboratory period all students should start the new topics together, uncompleted work of earlier periods being made up in time outside of regular hours, for which, as well as for extra voluntary work, the laboratory should always be open. The amount of work laid out for each period may best be adjusted to rather above the average student; and more exact and detailed work may be expected from the best members, while the poorer must be permitted to do it much less completely and accurately.

In the matter of order, etc., in the laboratory, much must depend upon local conditions, but certainly a reasonable liberty of conduct is very conducive to natural methods of working. Students should, of course, be expected to keep their own places and instruments in good order, and to take a corporate pride in the appearance of the laboratory as a whole. They should learn to put away every tool after using, as an integral part of the very act of using. They should be encouraged to work in physical comfort and with deliberation, and to be exact and neat in all their work, doing it always well, and, at certain times or with selected topics, the best that they can. But of course even order and neatness can be carried too far; and there is, as in other things, a certain *optimum* of these qualities that should be sought

for the laboratory rather than the *maximum*, which demands an undue and uneconomical expenditure of labor.

This principle of the *optimum* rather than the *maximum*, as a working guide, is indeed of wider application than this. It is a fact in education, as in physiological and economic phenomena, that the return for labor expended increases up to a certain point, beyond which any further advance is made at a disproportionately great cost. This, of course, is the well-known law of diminishing return from land. It is this best, or optimum, point which the teacher should in general seek; and he should not, as a rule, compel his students to follow refinements too far. On the other hand, it is true that in the face of competition in the world outside it is the maximum that most men are forced to, while this is the logical end in investigation, art, music, and one's specialty, whatever it may be. While, therefore, the teacher should be content with the optimum as a general rule, there are times when it is best to encourage individuals to the attainment of their maximum, their very best possible.

In the management of the laboratory, I think the teacher should take care not to expend more than a fair share of attention on the duller students. Education does not undertake to make a new man, but only to make the best of the man there is; and the good student is as entitled to have the best made of him as is the poor one. School and college are after all but a preparation

for the world outside, and the world does not devote more attention to its dull than to its bright members. I do not mean that the dull students are to be neglected by the teacher, but simply that they are to receive only their fair proportion of attention; and I hold that it is just as much the teacher's duty to take time to lead on the best pupils into still higher achievement as to urge the duller to greater efforts. It is not, however, the dull students who most try and discourage the teacher, but those indifferent ones who are in college or high school in some number nowadays, not from liking or ambition but simply for enjoyment or fashion. Such students tend to view their studies as a necessary evil to be disposed of in the easiest way possible, and at times take no great pains to conceal their contempt for it all. I think the teacher's first duty in such cases is to try to save such material for scholarship by endeavoring to awaken some intellectual interest. Very commonly this can be done, for such students are not inferior to others in ability; but if, after reasonable effort, he fails, I think his whole duty is to see that the student does enough work to justify the institution's requirements, while beyond this he should waste no more effort or regrets upon him.

In the laboratory most things should be done, as a rule, in the investigation spirit. The student should find most of his work placed before him in the form of definite problems so arranged that their solution comes just

within reach of his own powers. In general, nothing should be told a student that he can find out for himself, though with beginners, where everything is new and unfamiliar, this principle must be used with great caution. Indeed, at the opening of the course, the teacher should make much use of the didactic or demonstration methods already familiar to his students, even to the extent of having them at first simply confirm information given them or imitate methods shown them; and they should be brought only gradually into the full use of the independent or investigation methods. There are many occasions on which it is best to tell minor things outright to the student in order to help him to the solution of more important questions; and there are other occasions when leaving him unaided would result in discouragement followed by a distaste for the subject. The best procedure in such cases is to ask a question, or give a suggestion, in such a way as to allow the student the pleasure of finally solving the difficulty for himself. It is in such points as this that sympathy and judgment, and knowledge of the minds of young people, count for so much.

The teacher will, of course, constantly use such common and sound teaching devices as proceeding from the known to the unknown, — always recalling to a student his previous knowledge as a basis for building new knowledge upon. Again, he should remember to make effort essential to success, and should keep the re-

sponsibility for learning very largely upon the student. For these reasons the student should not receive aid and admonition at every step of his progress, but should be compelled to complete certain topics the best that he can before they are shown to the teacher for approval or criticism. Otherwise the teacher is soon doing the mental, and the student merely the mechanical, part of the course. But this principle, like all others in teaching, should be open to violation when good generalship demands. It is true the student will in this way make many mistakes and less apparent progress than on the alternative plan; but in this world there is nothing from which we learn so much as from our mistakes, and it is by constant struggling and effort that the mental fiber is strengthened. Again, it is important not to supply information, methods, terms, or tools until students have been made to feel a need for them. Such things then have a meaning, and make an impression upon the memory, far greater than when supplied without this connection.

Of course all laboratory work is to be carefully examined after it is completed by the student, and should be marked when approved. In my own experience I have found the following a satisfactory system, — to place a small oblique mark at the lower outer corner of each page when it has been examined, which is made a cross when the page is finally satisfactory; and the responsibility for having all their pages completed, examined, and checked

is thrown upon the students. This examination of the work is best made with the student, not apart from him.

A special phase of laboratory work needing some particular comment is experimentation in Plant Physiology, which has become an integral and invariable constituent of every modern general course. A great amount of experimentation upon many and diverse topics is now quite practicable even in elementary courses, but reason and experience both unite to approve a limited amount which should deal with the most fundamental topics and be carried out in the most scientific spirit. This principle is recognized in the two important standard courses printed in the Appendix to this book, where the experiments are limited to about fifteen. At first sight it may seem impracticable to teach experimental Plant Physiology at all to large classes, and so it is on the plan of purely individual work. But there is a method of teaching by demonstration, supplemented by individual work, which is well-nigh as efficient as individual work, and at the same time wholly practicable. As I have developed it in use, it is this: With the entire class assembled, and only the bare materials for the experiment upon the table, I try first to make sure that the importance of the problem to be studied, and its connection with their laboratory work, is made clear to the students; in fact, I try to make the experiment seem not only a logical but a necessary step in the subject. Then I set up the experiment from

the beginning, explaining the reason for each step and for the use of each piece of apparatus, each reagent, and the like. The students follow, asking what questions they wish and making full notes. The completed arrangement is then placed under the requisite conditions until the result is ready, when it is brought a second time before the class; the whole matter is then briefly reviewed and the result is exhibited or the test applied (not without attention to details of striking effect), as the case may be, and of course the results are fully discussed. The experiment is then placed in the laboratory, and each student has to study it minutely, and make records (descriptions and drawings) of the appliances and results as if the experiment were his own. Then, by aid of an outline which suggests but does not state the leading matters in the topic, they are expected to prepare a synoptical discussion of the subject, incorporating in its suitable place their account of the experiment. This, of course, is examined and criticised like other parts of the work. In the outlines in Part II, I incorporate the experiments for use in this way, with sundry suggestions as to profitable procedure with each.

Experimentation in Plant Physiology cannot attain to its full educational value unless its scientific or logical quality is adequately safeguarded. A chief requisite for this logic lies in control experimenting, which consists in this: that whenever a plant is to be exposed to a certain change of condition, such as a special gas supply,

or special color of light, involving a considerable amount of experimental machinery or apparatus, then there should be a duplicate experiment alongside, alike in every detail of the experimental machinery and method, except that there is no change in the particular condition in question. In this way, and this way only, can one be sure that the result obtained is due to the change of the principal condition and not to some peculiarity of the experimental machinery or method. In the descriptions of experiments in Part II of this book I have often recommended the teacher to go to considerable trouble to secure controls in the experiments; but I can assure him, from a considerable experience, that it is well worth while. For the respect, appreciation, and attention given by the best students to experiments of this type, is very striking in comparison with their attitude towards less perfect kinds. And besides, the control kind is the right kind, the sort really representative of scientific work. Many of the fallacious physiological experiments recommended in current books, as I point out in the later chapter on errors, owe their fallacy to a neglect of control experimenting. Another element in logical experimenting is a search for sources of error, to which the teacher should give some attention, even in this course. It is an attractive and important matter into which I cannot take space to enter here, but the interested reader will find it somewhat fully discussed in the second chapter of my work on Plant Physiology.



Another feature of good scientific method is the expression, wherever practicable, of the results of physiological study, not simply in general statements, but in figures. It is, of course, agreed that it is qualitative and not quantitative results which are mainly sought in a general course; nevertheless, in conformity with the scientific spirit of precision, every opportunity should be taken to express matters in quantitative fashion, even though it is not appropriate to seek quantitative methods especially. And finally, the logical spirit requires that in records of physiological work the experimental results and the conclusions should be sharply distinct. The students should, therefore, be required to write up their experiments in such form that they express clearly and separately, *first*, the object of the experiment (which is usually a question asked of nature, and asked in such a way as to call for a definite answer): *second*, a description of the exact method and appliances used, with suitable illustrations of the latter: *third*, the precise results obtained, in figures or tabular form, when appropriate: and *fourth*, the conclusions derived from the results. In particular the third and fourth should always be understood as logically-distinct things, and the students should be made to see that the results, if the experiment has been correctly performed, are facts whose accuracy cannot be affected by any explanations, while conclusions are matters of another, and less important order, being personal affairs which may be wholly erroneous.

At other places in this book I have mentioned the need for investigation directed to find more illustrative materials for laboratory studies. In Plant Physiology this will take the form of a critical study of all the plants available to teachers with a view to determining for each physiological process, *first*, what plants are best adapted in practice, either because of the large quantities they yield, or for other equivalent practical reason, for the demonstration of that process: *second*, how much, quantitatively, may be expected therefrom; *third*, what quantities are yielded by the other, though less useful, available plants: and *fourth*, what special precautions should be observed in order to make sure of the best results. Into the large and attractive field here open, I have directed some of the activity of my own students, with a result that several contributions to this kind of educational-physiological organization, intended to be of direct use to the teacher, have already been published by them in the *Botanical Gazette*, while others are to be expected in the future.<sup>1</sup>

Upon this matter of the teaching of Plant Physiology I may seem to dwell over much, but there is this reason

<sup>1</sup> These papers are mentioned in the suitable places in Part II of this book. In summary, they deal with Chlorophyll Solutions and Spectra (in the *Gazette*, 40, 1905, 302), Root Pressures and Exudation (45, 1908, 50), the Numbers and Sizes of Stomata (46, 1908, 221), the Demonstration of Starch Formation in Leaves (48, 1909, 224), all by SOPHIA ECKERSON; with Transpiration Quantities (45, 1908, 254) by GRACE CLAPP; and with Protoplasmic Streaming (46, 1908, 50) by GRACE BUSHEE.

therefor, that it is still the worst taught of all the constituents of a general course, and one of the hardest of the parts to teach well. Yet all authorities now agree that no good course can be given without it. For this reason and one other, viz. that it is a specialty of my own, I may be pardoned for the space I give it in this work.

There is, finally, one other element in the good teaching of Plant Physiology, the importance of which grows upon me with experience, and that is neatness in experimenting. I think every experiment should be performed with efficient apparatus, carefully prepared and preserved for its special work, used in a condition of spotless cleanness, and set up with workmanlike mechanical exactness, while it should be given a distinctive place in the laboratory where it can occupy the center of its own little stage, enmargined with liberal space and such a setting as contributes to a pleasing and even artistic effect. These features are of value for two reasons, *first*, for their reflex effect upon the spirit of the workers, whom they induce, by suggestion, to make their own work a little more similar in character, and *second*, because they really reflect the characteristics of the scientific spirit. It is in conformity with this principle that I believe all apparatus should be primarily of an efficient sort, and not the makeshift appliances which one brings together temporarily, and which always do their work imperfectly. The use of such makeshift tools is always wasteful of time, temper,

and labor, while the difficulties of securing good results by their use is so great as to cause a shifting of the center of effort and interest away from the processes of the plant to the working of an uncertain machine. Besides, and this is a point of more moment, the use of such imperfect tools tends to inculcate an erroneous ideal of the real nature of scientific method, whose essence is precision, logic, and the exact quantitative spirit. The improvement of the teaching of Plant Physiology, even to beginners, is bound up, I believe, in large part, with the provision of better appliances, those which will be accurate, convenient, always ready for use, and even attractive in appearance.

From procedure in the laboratory we turn to that in the class room. Laboratory work alone gives a disconnected, even though thorough, knowledge of botanical matters, and must be supplemented by much other instruction in order that it may be suitably extended and welded together. The laboratory is the place for minute and careful work and the gaining of a real personal acquaintance with scientific facts and phenomena; but each topic thus personally studied forms a center of illumination for a large area around it, and about each of such subjects can profitably be grouped a considerable amount of theoretical instruction. This additional instruction should be given in part through requirement of the reading of a standard text-book, which should be thoroughly studied, but in part through demonstrations and conferences (which in college would take

the form of lectures), together with quizzes, examinations, and the other approved devices for securing that "attention, repetition, pleasure, and pain" which we were assured in former days were the basis of good learning. These demonstrations or lectures should be as fully illustrated, broadening, suggestive, and interesting as they can be made. In college work a profitable proportion of laboratory to other instruction has been found to consist in two two-hour periods of laboratory to one of demonstration or recitation and one of lecture a week. In school, where five periods a week are given to the subject, the proportion should represent at least two, and preferably three, double periods, with the remainder given to recitation and demonstration.

The third important phase of botanical instruction, correlative with laboratory and class room, is field study through suitable excursions. I have spoken already of their educational value in an earlier chapter, and need only repeat that while very valuable they are not indispensable. In most schools they present great administrative difficulties because of insufficient time, distance from suitable localities, and the size of the classes, not to mention the disciplinary problem introduced by the natural exuberance of youth, which tends to turn the excursions into picnics. In my own experience I have found that the number of students who can be kept attentive to the objects of the day, and who, moreover, can group themselves near enough to the leader to profit by his

explanations or exhibition of materials, is limited, and does not exceed ten. More value is given to excursions if they are made not simply observing, but also collecting, trips, either for materials to furnish greenhouses or gardens, or for specimens in connection with herbarium-making upon some one of the several possible plans.

## V. ON SCIENTIFIC, MAINLY BOTANICAL, DRAWING AND DESCRIPTION

IN the preceding chapters I have tried to make plain the true aim and the approved methods of procedure in laboratory study. There is one phase of the latter, however, of such importance as to require separate discussion, namely, the use of drawing and description in recording the results of scientific studies.

Exact recording of the results of laboratory work has several values. In the first place it is of great utility in general education for the training it gives in precision and proportion in the exposition of original data. Again, it serves to give definiteness and direction to the work of the student, and compels completeness in his observations and conclusions. Finally, it has this invaluable pedagogical merit,—it enables the teacher to make sure that the student has actually and fully worked out his topics. By verbal answers alone a clever student may convey the impression that he has seen an object fully, when in fact he has viewed it but superficially; but he cannot make even a passable scientific drawing or written description of an object until he has first seen it accurately and completely, and realized its construction.

The aim of the student in recording the results of his study upon any topic should always be directed towards producing a piece of good scientific exposition, that is, an example of concise, accurate, and vivid conveyance of his ideas to another. In this he is to follow the example of the best scientific models. For his purpose both drawings and descriptions in words are usually needed, since each expresses something which the other cannot bring out so clearly; but the two should supplement and not duplicate one another. From the teacher's point of view, however, the drawings are much the more important, since from them he can most readily keep in touch with the student's progress. Some training in drawing, therefore, is an important element in a student's scientific education. But it is essential for the teacher to realize that scientific drawing does not consist in the composition of pictures correct in perspective and fine in finish, but in the making of diagrammatic outlines which convey to the mind of the beholder accurate conceptions of the real construction of the object represented. A diagram, even though unrecognizable as a picture of its object, if it correctly represents the structure when supplemented by some words of explanation, is a far better scientific drawing than one which arouses admiration by its fidelity to nature as a picture, but fails to express the actual structure. If a drawing can be at one and the same time an accurate diagram of the structure of an object and a picture giving a true impres-



sion of its appearance, so much the better; and indeed this is the ideal in scientific drawing. But diagrammatic accuracy is its first quality.

Drawing in the laboratory should be commenced only after observation of the main features of the object has been completed, though the very act of drawing will call attention to features likely otherwise to be overlooked. Drawings should not be pieced out or idealized from several specimens, but rather should be accurate delineations of a chosen typical specimen, which the student should be taught as soon as possible to select from several presented to him. In the very first lesson he should be given a familiar object, and told first to study and then to draw it without help, himself selecting the number and kind of views necessary to illustrate it fully. Many students under these circumstances answer in despair that they cannot draw. This answer is a sad commentary upon our modern system of education, which so largely neglects this most natural, elemental, and valuable discipline, thus depriving the student of training in an additional and vivid mode of expression. Of course all students must be required to try to draw; and if perspective, shading, etc., are at first discouraged, and correct outlines alone are insisted upon, all find that they can draw somewhat, and many find in themselves an unsuspected power of drawing well. Certainly the artistic talents of individuals should receive the greatest encouragement and stimulation, and

if some can accurately shade so as to make their diagram a good picture, so much the better. But at first the drawings must be, above everything, clear, accurate diagrams of the actual structure, such, *e.g.*, as Figs. 14, 16, 17, while if they can also be good pictures, like Fig. 15, it is just so much the better. To this end every line and spot in them should represent some feature in the object, and no mark of pencil or pen should be allowed to the equivalent of which in the object the student cannot point. Moreover, outlines should be complete, and no loose ends, nor hazy joinings, nor dim angles, should be permitted. Such imperfections generally correspond to loose, hazy, or dim ideas, which it is one of the chief uses of the drawing to help remove and replace by clear and sharp conceptions. It is for this reason that the generalized diagrams, to be spoken of later, are of such great value. I have found that "rough drawings," which scarcity of time may sometimes seem to justify, are of very little use; while the impressionist kinds, often really beautiful, made under teachers untrained in scientific methods, are little better. This matter is the more important since, unfortunately, much of the drawing done in the lower schools in connection with nature-study leans too much towards this impressionistic, and too little towards the diagrammatic character. The diagrammatic drawing takes but little if any longer, and is many times more valuable. Indeed, a mere "drawing" of an object, *i.e.* a representation of its appearance

to the eye, a reproduction of the impression the object makes upon the beholder, has little scientific value in connection with laboratory work, and is usually not worth the time it takes. Such a drawing is in place in a drawing class, and even in certain phases of general natural history study; but it reflects not at all the clearly cut ideas which should characterize the activities of the laboratory.

The drawing should include not only plants and their parts, but also some mechanical objects, for only in this way can correct proportioning as well as correct outlining be insured. Most students who can apparently draw plants very well make very bad drawings of bottles, flowerpots, or other such objects having definite lines and angles. This is, of course, because plant parts are mostly so variable in form that a wide deviation from their actual shapes is possible without detriment to the apparent accuracy of the drawings, while in the case of mechanical objects, any inaccuracy of proportioning is obvious at once. For such drawing the apparatus used in the experiments in plant physiology affords particularly good material; and for this reason, as well as others, the teacher should insist upon its accurate representation.

Scientific drawings, especially when made by beginners, are of course mostly freehand. Students should be taught first to outline the features of the object faintly in pencil, next to modify and alter this to closer agreement with the original, then to go over the whole with firm, uniform, com-

plete lines, and finally to erase the superseded lighter pencil marks. All mechanical aids from rulers, compasses, and the like should be allowed when they contribute to accuracy.

The paper for the drawings should be of a quality which will take both pencil and ink, and permit of clear, sharp outlines. It should not, on the one hand, have a glossy surface, nor, on the other, should it be rough like that used for their sketches by artists. An erroneous impression prevails among teachers untrained in scientific methods of work that scientific drawings should be made with soft pencils upon rough paper, in close imitation of the methods and results of the classes in sketching. After trial of many kinds of paper, I have found that the sort called commercially "ledger paper" gives the best results. A somewhat hard pencil is needful, especially for finishing the drawings, if ink is not used, and the Faber 4 H has proven in my experience best for the purpose. Each student should of course be provided with a fine flat file, or the more usual small sandpaper block, for keeping a good point on the pencil, while of course every laboratory is provided with some form of good mechanical pencil sharpener.

Economy in the number of drawings made to illustrate an object should be emphasized. Just so many views should be drawn as are necessary, when wisely selected, to show fully the structure, and no more. Thus, for a seed

like the bean (Figs. 14, 15), two drawings are sufficient; an end view in addition would bring out little if anything not already in the other two. One view of an object need never duplicate features already shown in another, though different views of the same feature are always desirable. The extreme aspects of an object should be chosen for representation, *i.e.* a face or edge view should be an exact face or edge, and not a quartering view. Of course, different drawings of the same object should be perfectly consistent in size, form, and structure.

The scale of the drawing in comparison with the original object is very important, and should always be expressed. In good monographs this is usually done by use of a fraction; if the drawing is one half the length and breadth (not area) of the original, the fraction  $\frac{1}{2}$  is placed beneath the drawing; if the drawing is twice the size of the original object, it is expressed by  $\frac{2}{1}$ ; if the same size, by  $\frac{1}{1}$ , and so forth. The best general rule as to scale is to make the drawing as small as will allow all the features which it is desired to represent to be clearly shown. If, however, the clear representation of the smallest features would make the entire outline inconveniently large, it is better to make two drawings, one of them showing the details upon a larger scale. It is well to give the students small pasteboard or celluloid rulers, preferably on the metric system, which can be kept in pockets in the back of the laboratory books, ready for use in making the scale of the drawings correct.

The labeling of the different features of the drawings with the appropriate terms or names should be carefully done. The exact spots to which the names apply should be shown by fine-ruled dotted lines, as in Figs. 14, 16, 17. In printed books, for appearance's sake, usually only single letters are thus attached to the drawings, and the corresponding names are given in an explanation below or in the text. But in laboratory work I have found that the extra neatness of this plan does not compensate for the loss of time entailed on the teacher in looking up the explanations, and I think it much better to require the drawings to be labeled with the names directly, as shown in Figs. 14, 16, 17, where the whole explanation is visible at one glance. For this labeling a compact vertical writing, or even printing, is desirable, and should be cultivated when wanting; and a compact writing is pleasing, too, for the notes. When one set of words can be applied to two or more drawings, as in Figs. 14, 16, 17, it is an advantage, but of course is not essential. Where the views of an object do not fully explain themselves, they should also be labeled beneath by descriptive words, such as "face view," "transverse section," and so forth. Different drawings of the same object, unless their connection is perfectly obvious, should be kept in correlation with one another by suitable cross-references. Of course neatness and pleasing effect are desirable qualities in all work, and some attention should be given to

on the page, *i.e.* with the long axis upright, an ample margin, and plenty of room between different drawings of the same object as well as between different topics.

In all of these matters just mentioned, *i.e.* completeness and clearness of outline, economy in number, scale, labeling, pleasing effect, it is a very good principle, pedagogically, to allow the students at first to do the best they can without aid. After they have made their own attempts, they are in a position to understand and profit by the teacher's hints as to how they may do better. Instruction on any points, after their own efforts have made them feel the difficulties, has much more meaning than it has before they have tried for themselves. It is important, however, not to confuse by too many suggestions at once. It is much better to point out improvements in but one or two respects at a time, and thus to bring the work towards a high standard gradually. On this plan the earlier drawings will be incomplete; but they may subsequently be brought up to the higher grade, or left as a record of progress, not without its value. It is a marked advantage to the poorer students to see frequently the work of the better, and, if the matter is tactfully managed, a stimulus to still higher accomplishment can thus be applied to the leaders. From the first, however, it is necessary to insist that the laboratory work **shall not be made a drawing lesson.** The laboratory hours **variation, comparison, and recording of essential for outline drawings alone can then be**

taken. All refinements should be added outside of these hours.

After the principles of diagrammatic drawing have been grasped by the students, the teacher may well give some suggestions as to the use of shading for expressing solidity, rotundity, and perspective. A drawing of this character, made by a student, is shown in Fig. 15. In this particular those teachers and students who have had some training in ordinary drawing are at an advantage, but all can learn for themselves something of its simpler principles. To this end the best procedure for the learner is to select from a good book a well-shaded drawing of a familiar object, and then, with both object and drawing before him, to copy the drawing with care, noting just where the shading is made heaviest, and the apparent reason therefor. Particularly fine models of such drawings, involving many familiar objects drawn much as the student should aim to do them, are found in the plates in SARGENT'S *Silva of North America*, a work further mentioned in the chapter on Books. A few trials of this sort with different objects — seeds, twigs, fruits — will show that the subject is, after all, very simple, and that a few precautions, especially in the use of the deepest shading for the darkest shadows, and in the treatment of the object as lighted from some one direction, will enable the student to produce very satisfactory results. I know at least one person who by this method taught himself to use shading tolerably well.



The use of ink, instead of pencil, for finishing drawings has manifold advantages, and only the drawback that it takes more time. The ink makes the drawings safe against rubbing through handling of the books; but the chief merit of the method consists in the far better appearance of the drawings themselves, both as to clearness, permanence, and artistic effect, an improvement which tends greatly to foster the very desirable pride of students in the appearance of the results of their work. In the case of my own students, the use of the ink is made voluntary with beginners, though it is required in advanced courses, where most of the extra work entailed must be done outside of the laboratory. But, almost invariably, the best students, after they have once tried the ink, take to its use altogether.<sup>1</sup> Liquid India ink, sold by all stationers, is the best, and gives results far superior to any other kind. Care must be taken to prevent it from drying up in the bottle, which should be kept stoppered even between dips of the pen. The finer writing pens (Gillott's 303 or 171) are best for the purpose. Of course the outlining must first be done in pencil, the marks being erased after the ink has been added.

<sup>1</sup> Incidentally, the use of the ink in this way will teach the students the mode of preparing drawings for publication by the commonest of the modern methods of picture reproduction, viz. line cuts by photo-zincography. Pencil drawings can be reproduced only by the less satisfactory half-tone process, or by the very expensive lithography. This subject of the modes of preparing illustrations for reproduction by the various modern methods is synoptically discussed by C. R. BARNES, in the *Botanical Gazette*, 43, 1907, 59.

Shading can be added either by stippling (fine dots, made more numerous for a darker shading) or by cross-hatching (fine lines parallel and crossing) or even, though this is less desirable, by use of a hard pencil. Care must be taken in the use of such shading, however, to guard against the universal tendency of beginners to make it too black. Here, as in all other phases of drawing, every encouragement should be given to individual artistic tastes, even to the point of allowing some use of color. But it is constantly necessary to guard against the eclipse of the naturalist by the artist; and the beautiful drawings must be allowed to be no less accurate than those which are merely diagrammatic.

While scientific drawing is a unit as to its aims and general methods, there are several forms of it adapted to different uses. First of all, and that which beginners will mostly use, are the simple outlines without attempt at perspective, of which examples occur in this book in Figs. 14, 16, 17. They are best when they exhibit fidelity to the form and features of the object in conjunction with evenness, completeness, and economy of lining. Next come the shaded drawings, exhibiting solidity and perspective, the shading being added by varying blackness of penciling, or, when ink is used, by stipple or cross-hatching. A good example is shown in Fig. 15 in this book. Another kind, applicable principally to the drawing of physiological or other apparatus, though also useful for some plant structures, is the outline perspective, in which the outlines are



so arranged as to give the effect of perspective without the use of any shading; and examples thereof are given in Figs. 4, 6, 19 in this book. This is a useful sort which it is well for the student to learn to make. Finally, there is a kind, extremely useful for showing the exact construction of apparatus set up for experiments, in which everything is shown in exact median section (or in optical section), while conventional markings on each part indicate its composition at a glance. This method, which is perhaps too special for use in an elementary course, is illustrated by Figs. 10, 20, and others, in this book, and by most of the figures in my work on Plant Physiology, where, unfortunately, the use of the conventional signs is not consistently carried out. Some additional matter upon scientific drawing in its more special phases, including an account of the valuable method of drawing from photographs by the intermediate use of blue prints, is given in the last-named book.

Drawing with the microscope might seem at first sight to offer particular difficulties; but, in fact, this is not the case, since most objects are seen, and are to be drawn, in but one plane. There is an instrument, the camera lucida, which makes drawing with the microscope a simple, accurate, and almost mechanical operation; but its use belongs rather with advanced courses, and the beginner may best do all of his drawing freehand. In drawing cells care should be taken to represent them, as far as possible, with their walls complete, not ragged and unfinished as the

sectioning instrument is likely to leave them; and certainly the drawing should clearly distinguish wall, cavity, and intercellular space. In drawing tissues it is a good plan, on the diagrammatic principle, to shade all walls, leaving their cavities and intercellular spaces blank, even in cases where the reverse would make a better picture of the object. Here, as elsewhere, diagrammatic clearness is the highest quality of a scientific drawing.

The copying of published drawings, in addition to its occasional use in teaching good methods of drawing, has a value at times in connection with the completeness of the students' records, especially when material for an original drawing is poor or wanting at a crucial juncture. Then a good drawing copied from an authoritative source is certainly better than no drawing at all. But, of course, this method must be considered an emergency measure, and should be used only after assurance of the complete understanding of the drawing by the student, and with suitable acknowledgment of the source written beneath it.

Generalized drawings or diagrams, designed to express in the simplest possible form the comparative development of morphologically-identical structures, and worked out in color or suitable shadings, have a very high educational value. They are called for a number of times in Part II of this book, where examples occur in Figs. 18, 24, 35. Their correct construction necessitates the greatest clearness of ideas, and inculcates comparison and generaliza-

tion of the highest value. Indeed, such diagrams demand thinking of well-nigh mathematical exactness and clearness. The coloring to show the homologous structures can be added by water colors, but is more conveniently and economically given by pencils, which may be bought in small boxes containing six colors.

It may seem to the reader that in giving no less than a dozen full pages to the matter of drawing alone, I ascribe to that subject an importance exceeding its actual value in any good course for beginners. Besides, the reader will doubtless agree with the opinion of an assistant of mine, who tells me this chapter is simply interminable. I fully admit the objections, but wish to say in defense that I warned the reader in the Introduction that I am treating all subjects more fully than I expect them to be used in any single elementary course. I do this in part to provide a definite basis for further discussion and progress, in part as an aid to the self-education of the teacher, and in part for the sake of presenting abundant material from which selection may be made according to tastes and local conditions. Some teachers will derive greater educational value from a strong emphasis upon drawing, others from a different sort. It is my aim to treat all matters as fully as I think can be of worth in any elementary course, on the basis of what seems to me the best educational experience. It is the teacher's part to use his judgment as to whether these suggestions have value for him.

The descriptive notes should be complementary to the drawings, not a repetition of features these show. Whatsoever can best be expressed by drawings should thus be represented, and what can best be expressed in words should be written. The notes should be as condensed as possible, both for the effect upon the student's composition and also for the convenience of the teacher who has to examine them. They should, as a rule, form complete sentences, of terse and expressive English. Indeed, scientific study offers peculiarly good material for training in expression, and some arrangement to that end should be made between departments of English and of Science. In suitable places the notes should be thrown into tabular form. Drawings and notes should, of course, exhibit their mutual connections, which they do the better if they stand opposite one another on facing pages, with suitable cross-references and titles.

In addition to drawings and descriptive notes there is another form of expression particularly valuable where figures are concerned, and that is by graphs, commonly called curves. The graphs bear very much the same relation to tables of figures that pictures do to words; that is, they not only express numerical data clearly to the eye at a glance, but they also bring out facts and relations which would not be suspected from inspection of tables of figures alone. But their mode of construction, though simple, hardly has application to the work of an elementary course in Botany,

unless perhaps in certain phases of physiology. The teacher who desires to know more of their construction and educational use can find them fully described and illustrated in my book *Laboratory Course in Plant Physiology*, second edition.

Synoptical essays, prepared after the completion of work under each topic, are a very valuable kind of record, for their preparation involves review, study in proportion, generalization, conciseness, and directness. They thus secure most of the values of examinations, and may well be made a substitute for the latter. They should be strictly limited in length, though required to include all matters of importance. Their English should be of the best, and it certainly would be an advantage if they could be made to count as work in English composition. It is not at all intended that the essay shall simply repeat material already carefully recorded in the laboratory books; it is rather a comprehensive but synoptical outline of the entire subject based upon all sources of information, — laboratory work, reading, lectures, or demonstrations. The essay should be primarily a study in proportion and correlation. After the students have done their best with their first essay, it is well for the teacher to read them a selected one, or even one composed by himself; and to illustrate this point there is given in Part II, Section 3, of this book, an essay which I have read to my own students after they have completed the study of the seed, as called for in the first three

sections of the outlines. Of course these essays should be corrected by the teacher and returned to the students, and they should be preserved permanently with the other records of the student's work.

There are several different methods of preserving the records of work, and most teachers have some favorite way of their own. Each has its merits and also its drawbacks, some of which are manifest, while others become known only after use. Very commonly the records are made upon separate sheets, often of different paper for drawings and notes, and these are finally preserved in a portfolio, or some kind of cover with adjustable fasteners. This arrangement is convenient for the hour of use, but has the objection that the result is neither neat, homogeneous, nor compact for permanent preservation. So far as I can find, no form of cover with mechanical fasteners has yet been invented which is efficient and convenient. If obliged to use any poor system, the student takes less pride and satisfaction in the progress of his work, and, therefore, gives less care and neatness to the preparation of records. Moreover such covers cannot be conveniently and appropriately preserved among his other books, though this is a desideratum from all points of view, and especially from this, which has been amply illustrated in the experience of my own students, that if the student himself becomes a teacher, his records will be of much practical use. No system has been devised, and probably none can be developed, which



will meet all the conditions of the case, but after trial of many methods I have concluded that a well-bound book offers, upon the whole, the optimum combination of advantages; and I have invented a special laboratory book which I have used for several years to my great satisfaction. It is made of the best quality of ledger paper,  $8\frac{1}{4}$  by  $6\frac{3}{4}$  inches, is ruled on the right-hand page for notes and unruled on the left-hand for drawings, is strongly bound in linen, and is stamped on the cover with the name of the institution and course. It is offered for sale by the CAMBRIDGE BOTANICAL SUPPLY COMPANY, and a sample is sent by them to teachers. Experience shows that a thoroughly good book of this kind, even though somewhat expensive, pays well in the end, and especially in the satisfaction which the best students take in its possession.

Students who become especially interested in their work often ask to have their records examined in the rough before placing them in the books, doing this in order to avoid the chance of having to mar the pages by erasures or other corrections. Though the intention is laudable the results are not good, for a reason which I have earlier given (page 79), *i.e.* because even the best students under these circumstances tend to rely overmuch on the aid of the teacher. I have found it much better in every way to require them to enter their records at once, the best that they can, in their books, making the corrections later where needed. The principle should be established that the books represent

primarily a record of the student's progress rather than a correct synopsis of the subject.

Finally I wish to repeat, in connection with this matter of making of records, the same warning I have given for other phases of teaching, that while a knowledge and habitual use of the methods approved by general experience is, from all points of view, desirable, at the same time the teacher must guard against too close a devotion to these, and should hold himself free to depart therefrom whenever he feels that his course can profit thereby. Never should he allow formalism to become dominant, or to subordinate the liberal, elastic, progressive, adaptive, spirit in which the work should be carried on. His course should grow like an organism, with its groundwork laid down in accord with the experience of heredity, but with a large margin of possible adaptive adjustment to the immediate conditions of the surroundings.

## VI. ON BOTANICAL LABORATORIES AND THEIR EQUIPMENT

BOTANICAL laboratories are of many sorts, from those built especially for their purpose by some of the greater universities down to unaltered schoolrooms; but all have this in common, that the rooms and their furniture are of far less account than the person who directs them. That is to say, it is more profitable to give a good teacher to a poor laboratory than a good laboratory to a poor teacher. Laboratories, like methods, are tools for skilled workmen, and they give but indifferent results in the hands of those untrained in their use. Suitable laboratories every teacher should strive for; but he is not to suppose that good work must be put off until he achieves them.

Many universities, some colleges, and a few high schools now possess good botanical laboratories; and if a teacher has the opportunity to direct the building of a new one, he should study some of these, and ask advice of their directors, whose addresses he may obtain by writing to the Professor of Botany in the principal university of his State. In universities and some colleges, the general or elementary laboratory, the only one with which we are concerned in this book, is part of a building devoted entirely to botanical

education. One of the most recent and best of such buildings in this country, and one altogether admirable in its completeness, efficiency, and pleasing finish, is Clark Hall of the Massachusetts Agricultural College, at Amherst, Massachusetts. In colleges the laboratory is usually part of a building devoted to biology, or to the sciences, while in schools it is almost always a single room in a general high school building. As for high school botanical laboratories, we have some admirable examples in this country, especially in the Middle West, where botanical education in the schools is far more advanced than it is in the East. Illustrated descriptions of some of these laboratories have been published in journals accessible in all large libraries,<sup>1</sup> and the teacher who has the opportunity to develop a new laboratory should make use of the suggestions in those articles.

First we consider the laboratory room. The prime requisite is abundant light, which implies as many and large windows as can possibly be provided. These it is

<sup>1</sup>The fine laboratory of the Detroit Central High School is described and pictured by L. MURBACH in the *Journal of Applied Microscopy*, 2, 1899, 425, and that of the Duluth High School in the same journal, 2, 1899, 353. Illustrated descriptions of College laboratories are contained in the same journal, — of Cornell University, by L. B. ELLIOTT in 1, 1898, 23; of Western Reserve University by F. H. HERRICK, in 3, 1900, 949; of Ripon College by C. D. MARSH in 4, 1901, 1149; of Vassar College, by A. L. TREADWELL in 5, 1902, 1717; of Morningside College by R. B. WYLIE in 5, 1902, 1949. A good synoptical description of the outfit needed for a small botanical laboratory is given by C. E. BESSEY in the same journal, 2, 1899, 232, and by S. D. BROOKS in 5, 1902, 1603.



PLATE I. — An admirable laboratory for a general botanical course.  
In Clark Hall, of the Massachusetts Agricultural College.



difficult to secure from architects, since they do not look well from the outside of a building, nor do they harmonize with the smaller sort which are ample for most other uses. The best-lighted laboratory known to me is that of Clark Hall, already mentioned, which has lofty windows upon three sides. This, with many others of its admirable characters, is well brought out in the accompanying photograph (Plate I), which I owe to the courtesy of its designer and director, Professor G. E. STONE. Where windows are provided upon only one wall, they should preferably face the north in order to avoid exposure to direct sunlight; but this point is really of no great consequence, since thick white shades perfectly temper the direct sun, and in short winter days it is an advantage to have the windows face in the lightest direction. Good lighting is favored also by tinting the walls white or nearly so, and by the use of light-colored wood for the furniture.

The size of the laboratory room, within limits, is better the larger it is. But since economy of room is usually necessary, it is desirable to know the size which experience has shown to be the optimum resultant between these conflicting conditions. Studies made to this end by C. S. MINOT have shown<sup>1</sup> that for each student the desirable working area is about 5 by 3½ feet, or 17½ square feet, while about 11 square feet in addition are necessary for

<sup>1</sup> Discussed in his very suggestive article upon the unit system in laboratory construction, in *Science*, 13, 1901, 409.

tables, cases, and extra space used in common: that is  $28\frac{1}{2}$  square feet in all for each student. For a division of 24

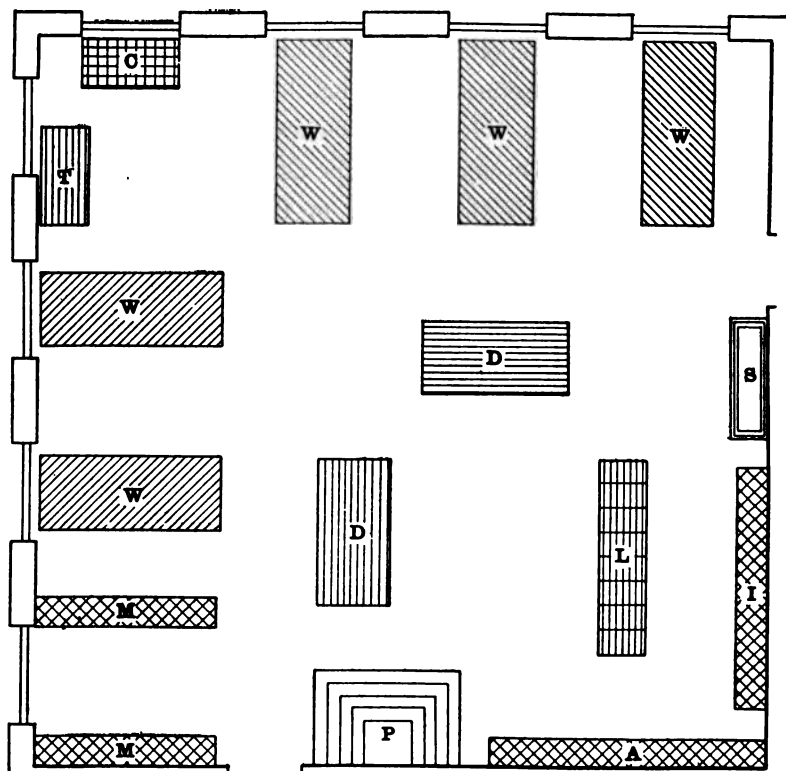

FIG. 1.—Suggestion for the arrangement of an optimum standard botanical laboratory, lighted on two adjoining sides; scale, 8 feet to the inch.

The room is 30 feet square and therefore 900 square feet in area, and is designed for a division of 25 students, each having approximately 35 square feet of space.

- |                                       |                           |
|---------------------------------------|---------------------------|
| A. Apparatus and books.               | M. Museum cases.          |
| C. Wardian case.                      | P. Teacher's platform.    |
| D. Demonstration and material tables. | S. Sink.                  |
| I. Microscope case.                   | T. Tool table.            |
| L. Locker or drawer case.             | W. Students' work tables. |



students a room would, therefore, require 684 square feet of area. For advanced laboratories, or others which are used exclusively for laboratory work, this is, I believe, ample. But in most schools the laboratory must also serve as a class room, museum room, and storage room for the apparatus and materials; and certainly this allowance is then insufficient. After some calculation and experiment I have concluded that 35 square feet to each student represents an optimum allowance for such a general laboratory, though, if necessary, it can be scaled downward to a minimum at about 30 square feet.

The form of the laboratory room is nearly always fixed by the plan of the building, but there is one feature which is practically indispensable, — namely, its long axis should run parallel with the lighted side, on which principle a corner room may be square. The form recommended by MINOT for a division of 24 students, each having  $28\frac{1}{2}$  square feet, is one 30 feet long by 23 wide; but I think a greater length in proportion to width is still better, even to a form practically twice as long as wide. This proportion is approximately embodied in the accompanying suggested plan (Fig. 2), which shows a room designed for a division of 25 students, each having an area of 35 square feet; it is 43 by 21 feet, therefore containing 903 square feet. If lighted also at one end, it could be shortened, and the Wardian case, sink, and tool table could be placed in the opposite corner. A square corner room, however, is better in every

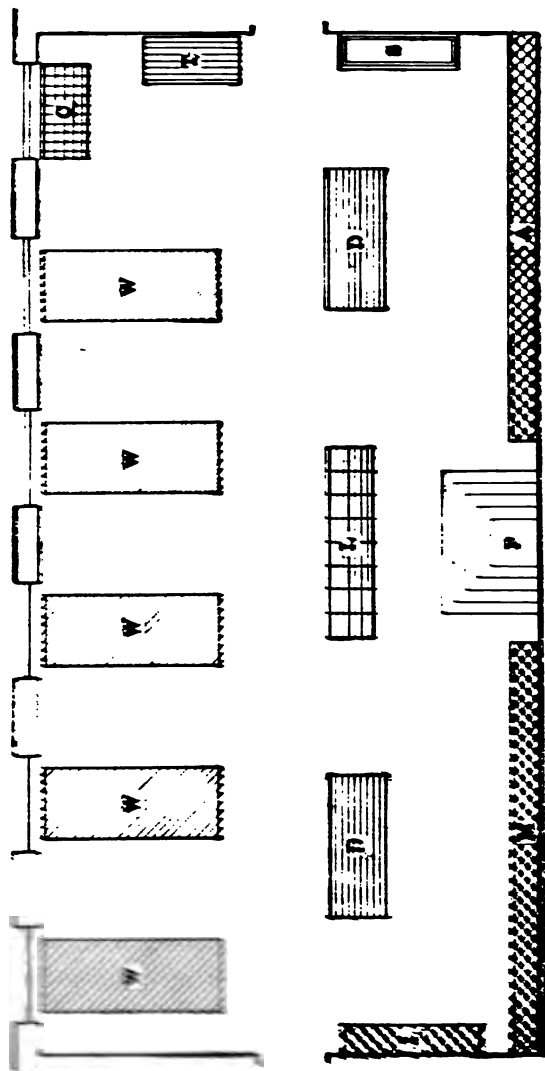

FIG. 67.—Suggestion for the arrangement of an optimum standard botanical laboratory, lighted only from one side; scale, 1/8 feet to the inch.

The room is 49 x 83 feet, and therefore 903 square feet in area, and is designed for a division of 23 students, each having 39 square feet of space. Letters are explained under Figure 3.

respect, as Fig. 1 illustrates, and it should be secured if possible. On the same basis of space, it should be 30 feet square, thus making an area of 900 square feet.

Thus much for the room; we turn now to its furniture, of which the work tables come first. Much study has been given to the development of good tables for laboratory work,<sup>1</sup> especially in advanced and special courses; but so far as our general course is concerned the subject is simple. Individual tables, with ample drawers and a locker for storage of the microscope, are, of course, the ideal; but they are usually impracticable because both of cost and room. I have tried many kinds and have concluded that the simplest possible form, that shown by the accompanying figure (Fig. 3), is, upon the whole, the best. The optimum size should be such that each student is allowed a space of 3 feet long, though this can be scaled down to a minimum of 2 feet if necessary, by  $1\frac{1}{2}$  wide. If the tables are arranged in the usual way, that is, with an end to a window, then the students will sit along both sides, and one may sit at the end, where the better light exposure compensates for its greater distance from the window. In this case 3 feet is a good standard width for the table, with 3 feet of length along the

<sup>1</sup> Detailed descriptions, with illustrations, of various forms of laboratory tables are given by M. J. ELROD in the *Journal of Applied Microscopy*, 2, 1899, 326; and there are other notes on the same subject in the same *Journal*, — by W. E. BRITTON in 5, 1902, 1968, and by P. A. FISH in 6, 1903, 2209. A design for a table adapted especially to the general laboratory is given by O. W. CALDWELL in his *Suggestions to Teachers*, 20.

side for each student and  $1\frac{1}{2}$  feet for the end place. Thus a table for 5 students would be  $7\frac{1}{2}$  feet long, and one for 7 students would be  $10\frac{1}{2}$  feet long. Drawers must somewhere be provided for the possessions of each student, and if the places at the tables are used each by only one student,

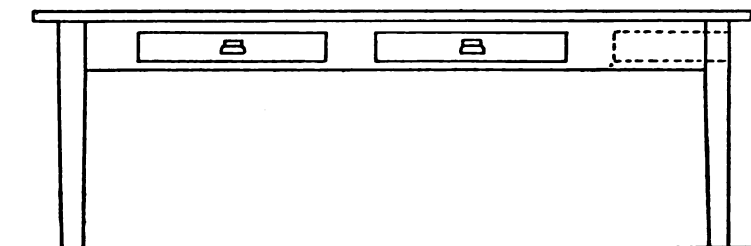

FIG. 3.— Elevation view of a good form of laboratory table; scale, 1 inch to 2 feet.

then shallow drawers at each place, as shown by Fig. 3, are most convenient; but if several students use the same seat, then drawers, lockers, or boxes, one for each student, with some for storage of supplies and the like, should be furnished elsewhere in the room, as shown in the accompanying plans. This arrangement is much more economical of table space than the alternative plan of vertical rows of drawers between the seats at the tables. All drawers should be furnished with handles (or "pulls"), which have a place for a label above (for name of student or of contents), and should be provided with a movable button check on the inside of the back to prevent any accidentally-complete withdrawal. The tables may be of oak for durability and effect; but pine or whitewood are nearly as good. The

tops should not be varnished, or they will be quickly spoiled by spilt alcohol, but should be finished simply with oil. Some teachers prefer black tops, especially for microscopical work, since there is less reflection into the eyes, and such tops may readily be prepared according to easily accessible directions.<sup>1</sup> It is also worth while to have each student's territory ruled off in plain boundaries.

While a rectangular table like that here described is the form most commonly used, some teachers prefer them of a wedge shape, widest towards the window, and narrowing away from it; for thus the students interfere less with one another's light, and, incidentally, the access of the teacher to all of the students is facilitated. These tables were invented by C. E. BESSEY,<sup>2</sup> and, as Plate I will show, they have been adopted in the fine laboratory of Clark Hall. Their advantages are manifest, and their only disadvantages are a somewhat greater cost of construction and a rather less economy of room.

A tight waste basket, which is ample for most of the

<sup>1</sup> Directions are given by F. E. LLOYD in his *Teaching of Botany*, 213, by W. D. FROST in the *Journal of Applied Microscopy*, 1, 1898, 145, and by P. A. FISH, in the same *Journal*, 6, 1903, 2211. Suggestions upon the general subject of the treatment of table tops are contained in other notes in the same *Journal*,—by C. W. DODGE, in 1, 1898, 121, by F. R. WRIGHT in 2, 1899, 231, and by H. H. WILDER, in 5, 1902, 1651.

<sup>2</sup> They are also described in the article by M. J. ELROD cited in the footnote two pages earlier. They were, however, reinvented in Europe, by S. ROSTOWZEW, as described and figured in *Botanisches Centralblatt*, 81, 1900, 361.

... should stand under each  
 ... with receiving seat ad-  
 ... with back but no arms,  
 ... with rubber caps on the  
 ... such a chair, which is  
 ... Fig. 2 I have in  
 ... although it  
 ... if the base  
 ... spread.



The room furniture of the  
 laboratory should include one  
 or two large tables for hold-  
 ing the supply of material  
 for the class and for demon-  
 stration use. These should  
 be built about three feet  
 high, which is the height  
 most convenient for a person  
 to use while standing; and  
 they should be situated in  
 convenient places to make cup-  
 boards or storage of class  
 material.

A teacher's platform,  
 with a desk or table on it, as well as else-  
 where in the room, should be provided for displaying dia-  
 grams, charts, and other material. The height of the platform should be about an inch

... by W. D.  
 ...

thick, four inches wide, and ten feet long, rounded on one edge to hold Dennison's No. 12 Card Holders (which are excellent holders for flat diagrams); these boards run in a light guiding frame, like a window frame, and are raised and lowered by cords attached as shown in Fig. 5, which also shows a cross section of the guiding case. The latter, however, is not indispensable. Two boards may be used in the same case, as shown by the sectional figure, thus allowing use of two tiers of diagrams. A tool table, with the simpler tools, facilities for heating with gas, and appliances for the manipulation needed in setting up physiological apparatus, is desirable, while a large sink, preferably porcelain-lined, and provided with several taps, is necessary. Lockers, or cases of some form for holding microscopes, on a principle later discussed, are needed, and

should stand against the wall; but if built separately, they should not rise over four feet from the floor in order that they may not obstruct the free view around the room. Also there is need for cases with glass fronts for the

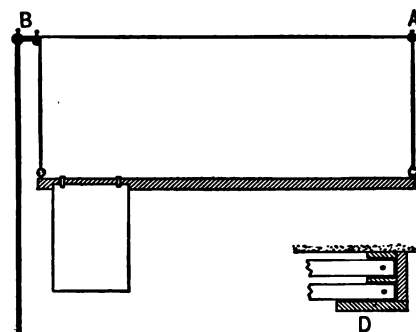

FIG. 5. — A successful rack for displaying diagrams. *A, B*, pulleys; *C*, cleat for fastening cords; *D*, cross section of the guiding case, enlarged.

museum collection (which is discussed later in this book), and these should be built with as much glass and little frame as possible, while the shelves should be adjustable to allow of rearrangement of materials accompanying growth of the collection. Upon all of these matters there are valuable hints, with illustrations, in the various articles descriptive of botanical laboratories already cited; and they are taken into consideration in the plans presented in Figs. 1 and 2. Museum cases and methods are discussed in the following chapter.

The arrangement of the furniture in the laboratory room must be fixed in part by local conditions, especially the positions of the windows; but certain desirable features are to be attained if possible. It seems generally agreed that the best arrangement of the work tables, for economy of both light and space, is that which brings an end to a window as shown on the accompanying plans. Tables parallel with the windows are sometimes used, and are very convenient, but they are wasteful both of space and light. If arranged end to the windows, a space of  $4\frac{1}{2}$  feet should be left between them to permit easy access of the teacher to all of the two rows of students, though this can be reduced to a minimum of 4 feet. The material tables should be near the work tables, and one window must be left free for the Wardian case, presently to be mentioned, as well as to give light to the tool table; while the other cases, the teacher's platform, and so forth, may



have some such positions as the plans of Figs. 1 and 2 suggest.<sup>1</sup>

A very important part of the furnishing of a general botanical laboratory is a suitable place for keeping plants alive and in health while under observation or experiment. In fact not much physiological or observational work on living plants can be done without something of this kind, since the dryness, gases, fluctuations of temperature, and other disturbances of an open laboratory are likely to cause abnormal results, or even no results at all. On the other hand, some suitable arrangement permits not only good physiological experimentation, but also the possession of a small collection of living plants, illustrative of important facts in morphology and adaptation, together with some that brighten the room and give pleasure to those who make use of it. Later in this book will be found some suggestions about these plants; here we are concerned only with some house for them. Best of all for this purpose would be a well-built and competently-managed conservatory opening from the laboratory. One's first thought would be that a small greenhouse could rather easily be built on the roof, or in some odd angle of a large building; but, in fact, such roof greenhouses are not satisfactory, partly because of the difficulties of trans-

<sup>1</sup> There are many valuable suggestions upon laboratory furniture, and related matters, in an article by L. B. ELLIOTT entitled "Representative American Laboratories" in *Journal of Applied Microscopy*, 1, 1898, 23.



was formerly in successful use in my own laboratory. The floor is a copper box, four inches deep, filled with water and heated from below by a Koch safety gas burner, which shuts off the gas if the flame goes out, while the flame is shielded from draughts by a sheet-iron hood, arranged to prevent access of injurious gases to the case above. The height of the flame is controlled by a Reichert thermo-regulator inside the case, which can be set at any desired point, and which keeps the temperature within  $3^{\circ}$  C. of that point, no matter how low it falls in the room outside. This case is, however, more elaborate than necessary, and, after my experience with it, I believe one would work well if

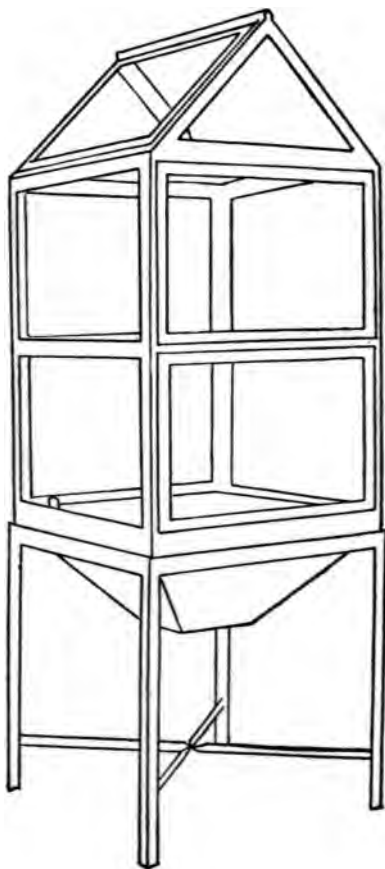

FIG. 6.—A successful Wardian case;  
scale,  $\frac{1}{2}$  inch = 1 foot.

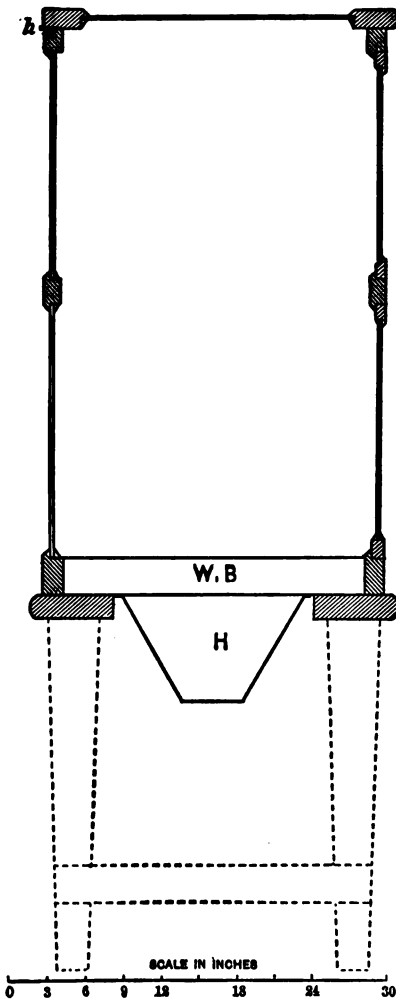

FIG. 7.—Plan for a Wardian case, in cross section. *H*, sheet-iron hood; *h*, hinge of top; *W.B.*, water box of galvanized iron; dotted lines show legs of table.

built after the plan shown by Fig. 7, and with the following specifications: heating box of galvanized iron made the length of the window, two feet wide and three inches deep, with a hole in one corner for filling, and a tight sheet-iron hood beneath, so arranged as to shield the flame and keep gases from rising through the joints of the case; heat from a safety burner, controlled by the thermo-regulator within the case; the sashes made with as little wood as possible; on one of the long sides two doors, which can be tightly closed; the top hinged to allow it to be opened for ventilation at

times; shelves of glass or wire netting added according to details of use; the whole case supported on a firm wooden table. It should not be built into the window, at all events not without an extra sash some inches from the window sash. I have no doubt that such cases, completely equipped and abundantly tested, will presently be offered for sale by supply companies, and that the incandescent electric current, automatically regulated, will be successfully used for the heating.

Another desirable item of laboratory furnishing is a small aquarium for water plants, and this is the more interesting, and likewise easier to keep, if it contains also some animal life; for a balance can thus be maintained which renders change of water or other close attention less needful.<sup>1</sup> It seems agreed that aquaria made of glass sheets set in a metal frame are safer from breakage, and generally better, despite their tendency to leakage, than the globular or other one-piece forms.

Thus far the laboratory room and its furniture; we consider next its equipment. Of this the most expensive part is the outfit of microscopes, which, however, as the chief tool of the biologist, ought by no means to be omitted. Through long and extensive use, and close competition

<sup>1</sup> A brief description of a successful balanced aquarium is given by L. MURBACH in *Journal of Applied Microscopy*, 3, 1900, 995. A recent book on the subject is *The Freshwater Aquarium and its Inhabitants*, by O. EGGLING and F. EHRENBERG, published by Holt & Co., 1908.

between makers, microscopes are now so nearly standardized in construction, use, and even price, that it is not only possible to give with some confidence the specifications of the kind best for a general course, but such instruments can be purchased at substantially similar prices from any of the leading makers, between whose excellent products there is little choice.

I have given a good deal of study to this subject with the result that I consider the optimum standard microscope for a general course to be one with the following features: The stand is of the simple continental type with horseshoe base (which will no doubt ultimately be made with rounded angles to facilitate cleaning), and the pillar is one piece, ending above in a perforation handle. This handle represents the greatest improvement in microscope construction of recent years, since it permits of lifting the instrument in a natural and convenient manner without that risk of injury to the fine adjustment mechanism which accompanied the use of the movable fine adjustment pillar of the older type, and which could be obviated only by the awkward expedient of grasping the instrument by its base. The mechanism of the fine adjustment is embedded in this pillar, but moved by a screw in the usual position. No joint for inclination is needed, and when present, is rarely, if ever, used. In consequence one might suppose that the base and entire column could be cast all in one piece, to the advantage of solidity, simplicity, and cheap-

ness; but I am told that mechanical difficulties forbid such castings, for which reason the joint adds no great sum to the cost. The coarse adjustment is effected by rack and pinion, which is so far superior to the slide tube in convenience, time-saving, and security to object and lenses, that I advise every teacher to consider it indispensable, and if necessary, to get along with fewer instruments rather than to buy instruments without it. The diaphragm should be of the iris type set into the stage, a form so much more convenient than other kinds that students will make use of it where they never can be induced to change the others. A dust-proof nose piece for two lenses, allowing these to be exchanged in a moment, is also, in my opinion, far too valuable in saving of time and trouble to be omitted. The objectives are two,—the lower of the power variously designated by different makers as 16 mm.,  $\frac{2}{3}$ , 3, or A, and the higher of 4 mm.,  $\frac{1}{8}$ , 7, or D. A single ocular will usually be sufficient, and should be of medium power, — 7.3 or III,—which allows, in combination with the above-mentioned objectives, magnifying powers of approximately 65 and 320 diameters, which is ample for all general work. In the accompanying figure (Fig. 8) I have sketched in elevation my idea of the optimum standard instrument, though none exactly in agreement therewith is now offered for sale so far as known to me. But approximately such an instrument may be bought from any of the makers at a duty-free price of

under \$30, and I advise the teacher not to buy any of less value. Yet, if needs be, the nose piece, and then the

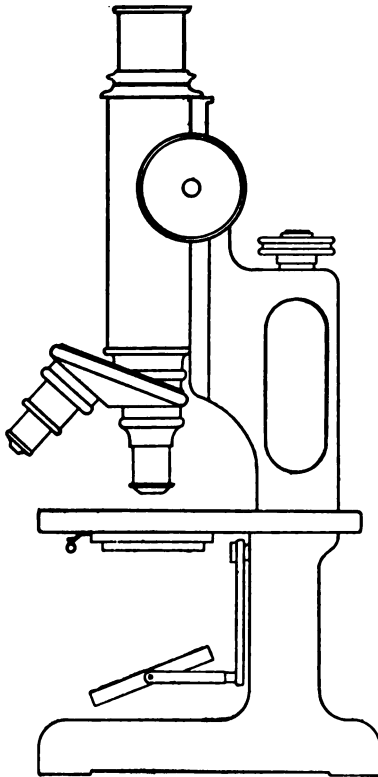

FIG. 8. — Sketch of an optimum standard microscope for use in a general course;  $\times 1$ .

rack and pinion, can be sacrificed, cheapening the instrument to about \$20. I am inclined to think, however, that an instrument lacking a fine adjustment but provided with rack and pinion is better than one having a fine adjustment in conjunction with a draw tube. The various accessories, substage condenser, camera lucida, micrometers, mechanical stages, and immersion lenses, while finding occasional use for exhibition or demonstration, belong rather with

higher courses. The condition of practical standardization of microscopes makes it reasonably certain that they



will not be superseded by any better forms in the near future; and, therefore, they may be bought in full confidence that they will remain permanently of the best type.

The leading manufacturers and dealers in microscopes in this country are the BAUSCH & LOMB OPTICAL COMPANY of Rochester, New York (with branches in Boston, New York, Washington, Chicago, San Francisco), and the SPENCER LENS COMPANY, of Buffalo, New York, while the European makers best known in this country, all of whom have agencies in New York City, are CARL ZEISS of Jena (who manufactures the instruments *de luxe* of the world), ERNST LEITZ of Wetzlar, C. REICHERT, of Vienna, and VOICHTLÄNDER of Brunswick. There are also firms, making instruments of much excellence, in France and England, but their product has little vogue in this country in comparison with those above mentioned. The duty on microscopes is forty-five per cent, but schools and colleges have the right of duty-free importation, and the price of the American instruments is adjusted to meet the foreign competition.

In number the microscopes should approximate one to each student, as nearly as possible, for not only is the wear and tear on each instrument thus minimized, but it is possible to hold students responsible for damage or dirt, to a degree which is impracticable where several students use the same instrument. Yet this latter must be the more usual condition, for, with large classes, it is rarely

possible, even for the colleges, to provide a larger number than one microscope to each member of a division, which should, however, be viewed as the irreducible minimum, though many there are who must make shift with less. In this case only constant and vigilant inspection will insure their decent care. Of course the teacher will give definite instruction upon their principle, use, and care; and he will be aided by the use of those very excellent little pamphlets and wall diagrams, supplied free to all users, by most of the dealers, — for advertising purposes, of course, but none the worse for that. Several ways are employed for storing the microscopes while not in use. Sometimes they are kept upon the tables, either in their own cases, or else under glass bell-jars, or even simpler coverings, but more often they are placed in lockers built under the tables or elsewhere in the room. After trial of different systems, I have concluded that while some of these methods have their merits for advanced students using individual instruments, a better arrangement for the general course is one in which the students always replace their microscopes in the cases, and then stand these on numbered places<sup>1</sup> on the shelves of a glass-fronted case, where the presence and condition of the instruments can be seen, with occasional inspection, far more easily than when they are kept in individual lockers. If the latter are used, I

<sup>1</sup> A set of steel figures arranged for stamping numbers in wood is most useful for this and other laboratory uses, and is of low cost.

think the doors should be paneled with glass to encourage neatness.

Dissecting microscopes, and these also in number as nearly as possible one to each student, are a far more valuable part of the laboratory equipment than is generally supposed. The compound microscope is a very perfect tool, but in fact there is much, especially in objects just beyond the unaided vision, which can be seen not only more conveniently, but far more clearly, with the simple or dissecting microscope; and the student should be taught to turn to that first, resorting to the compound instrument only when driven thereto. But the great advantage of the simple instrument lies, of course, in the fact that it permits accurate dissection, which the compound instrument practically does not. If the student settles down in a spirit at once deliberate and determined, centers his object accurately on the stage, finds the best focus and light, places his hands in position both comfortable and steady, and then with a definite problem in mind applies needle and scalpel point to its solution, he will be surprised to find how much and how satisfactory is the knowledge he can gather. Deliberation and definiteness are essentials in its use, for most persons seem to have naturally a tendency to expect that, after a few perfunctory passes on their part, the instrument will, by some inherent, subtle magic, do the rest, though this spirit is by no means associated only with this particular

instrument, but is common to the use of many others. Dissecting microscopes, like the compound kind, are now very largely standardized, and all makers offer, at substantially the same price, a form with horseshoe base, rack and pinion adjustment, mirror, and two lenses magnifying about five and ten diameters. Its cost is from \$10 to \$12, which can be reduced by the use of a sliding adjustment, though it is increased by a better grade of lenses or by the addition of arm rests, which, however, are a convenience rather than a necessity. Very much simpler and far cheaper forms, of good efficiency, are offered by several makers; among these the BARNES Dissecting Microscope, offered by the BAUSCH & LOMB OPTICAL COMPANY, at a cost of \$3.25 seems very good. As a last resort, and one not so very bad, a tolerably-efficient dissecting microscope can be improvised from the lens and instrument case described in the following paragraph.

The instruments needed by students for their individual dissections, manipulation, and so forth, are fortunately few and inexpensive. A hand lens of two powers, forceps, a scalpel, and two needles (scissors are not needed) are the articles most in use, and are supplied, at a cost not over one dollar, by all of the dealers in biological supplies. It is desirable to keep these together in a case, especially when used in field work where any study of classification is made, and I have designed for the use of my own classes the leatherette case shown in the accompanying figure

(Fig. 9). It is now manufactured for sale, at a cost of \$1.75 by the BAUSCH & LOMB OPTICAL COMPANY of Rochester, New York, and by some other dealers. The lens is kept in one end, and the dissecting tools in the other, while the case is made of such form and size that, when laid flat on the table with the lens-case resting upon it and the high-power lens projecting, this is in focus with



FIG. 9.—Dissecting instruments for botanical use, with case;  $\times \frac{1}{2}$ .

the table, while if the case is on edge, with the low power lens projecting, that is in focus; and thus a tolerably efficient dissecting microscope is improvised. Another instrument, of which there should be theoretically one to a student, is a sectioning razor. As a matter of fact, however, very much of the necessary sectioning can be done with the scalpels if these are kept reasonably sharp, for which purpose a suitable stone and hone should be accessible in the tool table. The finer sectioning can be done with a few razors, *i.e.* one to each of a division given out for the purpose, or even with fewer, especially in those cases where the teacher finds it more practical to make the finer sections for the students. This latter statement may seem a heresy, and is so, unless some form of necessity demands it, or unless, and this is equally to the purpose, the teacher can really teach better by this method.

Other articles contributory to best work by the students are pipettes, slides and covers, small rulers (preferably of celluloid), colored crayons, simple compasses, and erasers.

Apparatus for physiological experimentation is an essential part of the equipment of the modern general botanical laboratory, though its amount and character, beyond a certain irreducible minimum, must depend largely upon the methods of the teacher. I have described apparatus of all grades somewhat fully in the second edition of my book, *A Laboratory Course in Plant Physiology*, where the interested reader will find ample information. Apparatus for work in Plant Physiology is of several types, from *precision* (used only in refined investigations), through *normal*, and *adapted*, to *makeshift*. The normal type is that which is made for its particular work, and is applicable thereto with convenience and celerity while yielding quantitative results of inconsiderable error. This is the kind which in general is best for demonstration, and for individual work by specially interested as well as advanced students; and pieces for all of the important experiments can now be purchased from supply companies, notably from the BAUSCH & LOMB OPTICAL COMPANY, which attempts to supply not only such instruments, but all supplies and articles needed for any work in Plant Physiology. This firm issues a catalogue of its apparatus for plant physiology, descriptive especially of some eighteen

pieces, of normal and demonstration appliances, designed by myself for the study of the leading physiological processes. Several instruments are also supplied by the C. S. STOELTING COMPANY of Chicago, and some others by the CAMBRIDGE BOTANICAL SUPPLY COMPANY of Waverly, Massachusetts, though the instruments of the latter firm are mostly appropriated without authority or acknowledgment from designs which I have published. The adapted type of apparatus is that which is made up in the laboratory from approximately-suitable articles, — especially those manufactured for use in physics and chemistry, — which are altered, with more or less extensive additions, to fit the particular purpose. Designs for such apparatus may be found in the books devoted to elementary Plant Physiology, while they are described, in so far as they are connected with the work of a general course, in the second part of this book. Such instruments serve well for some purposes of demonstration, though unlikely to yield results of much accuracy. Finally, there is the makeshift type consisting in improvised arrangements of articles temporarily pressed into service. Such appliances consume undue energy and time in their preparation, require so much concentration upon the working of the mechanism as to leave little for the phenomena in the plant, and finally, through the inevitable inaccuracy of the results, inculcate a wholly wrong ideal of scientific work, as I have shown more fully in an earlier part of this book (page 86). It

is far better in every way for the teacher to accumulate gradually the needful normal or adapted pieces, and then to keep them, year after year, in good order in suitable

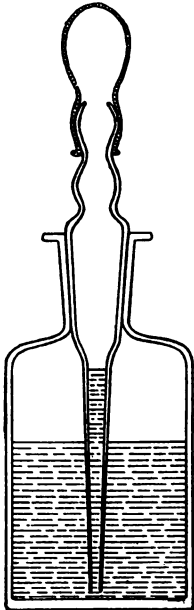

FIG. 10. — Sectional view of a good form of reagent bottle;  $\times \frac{1}{2}$ .

cases, always ready for immediate and convenient use. On the teaching of Plant Physiology to large classes, I have given some suggestions in an earlier chapter, while the particular appliances needed in a general course will be found described, with the usual allowance for the teacher's individual methods, in the second part of this book.

Certain reagents, though in no great number, are needed in the general course, and these also are mentioned later. For liquid reagents, to be used in small quantity, the best form of bottle known to me is one in which the stopper and pipette are all of one piece, as shown diagrammatically in the accompanying Fig. 10. Such bottles may be obtained, along with all needed reagents, from most of the firms dealing in botanical supplies, and of course may be bought from any of the many chemical supply companies of the country, — a list of which will be found towards the end of this chapter.



Abundant materials in suitable condition are a necessity for good study, and fortunately these are not expensive. They are partly to be bought in the markets or from greenhouses, partly collected a season in advance, while, as a last resort, some of the more spécial materials may be bought from a botanical supply company. Methods of preserving the various kinds of materials will be found described in Part II of this book, in the suitable connections. If the teacher has at command his own greenhouse and gardener, as many colleges have, he is fortunate. If he is near a botanic garden, he will find the director ready to aid him in anything which advances botanical knowledge. Commercial greenhouses, happily, are everywhere, and the teacher should make friends, and a bargain in advance, with the gardener for such materials as he needs, — bulbs, flowers, leaves, plants for experiment, and so forth.

Finally there are many small articles of miscellaneous equipment, certain tools, gas jets, balances, gas generators, small glassware, and other appliances, the amount and kinds of which must depend upon how fully the teacher goes into the respective topics. Particulars concerning such articles as are needed, and their use, are given in the suitable places in Part II of this book, and if the teacher desires further information upon their use, he may find it in my book devoted to practical Plant Physiology.

In reading these lists of necessities and desiderata for the

equipment of the general botanical laboratory, the teacher himself may experience some measure of that shock at the seeming expense which always afflicts the authorities in control of educational expenditure. But there is this to be said, that in the first place, as inspection of price lists will show, the expense is actually much less than seems probable, while in any event the cost of equipping completely a laboratory is insignificant in comparison with the cost of the building of which it is a part. In the second place, the equipment is substantially all permanent and not likely to be superseded, so that after it once is provided it lasts like the building itself, with only a moderate expense for maintenance and repair. Finally, it need not all be purchased at once, but may be added a part at a time until the outfit becomes gradually complete. In any case the teacher must insist upon the necessity for expenditure, but has the advantage of being able to say with assurance that the results are well worth it. One phase of laboratory expense is generally somewhat difficult to adjust, and that is the cost of the materials (seeds, plants, chemicals) actually used by the student in the course of laboratory study. In colleges this is usually supplied from a laboratory fee charged each student, and amounting to \$5 a year at least, and often more.<sup>1</sup> But in schools such a source of

<sup>1</sup> The justice of charging a laboratory fee to students of the sciences is usually supported by the argument that such students are receiving something which their fellows in other departments are not, and therefore it is fair that they should pay for it. There is, however, another view which

income is impossible, and in its stead the teacher should endeavor to obtain an annual appropriation of so much per student to meet these expenses.

The principal firms known to me as dealing in chemical supplies in the United States are MESSRS. EIMER & AMEND, of New York City: THE HENRY HEIL CHEMICAL COMPANY, of St. Louis, Missouri: and THE CENTRAL SCIENTIFIC COMPANY, of Chicago, Illinois: while THE WHITALL TATUM COMPANY of New York makes a specialty of laboratory glassware. The principal firms making a specialty of biological equipment include the BAUSCH & LOMB OPTICAL COMPANY, of Rochester, New York, with its several branches, as mentioned earlier, on page 129: THE CAMBRIDGE BOTANICAL SUPPLY COMPANY, of Waverly, Massachusetts: WILLIAMS, BROWN, & EARLE, of Philadelphia: THE KNOTT SCIENTIFIC APPARATUS COMPANY, of Boston, Massachusetts: THE C. H. STOELTING COMPANY, of Chicago: THE CENTRAL SCIEN-

seems to me more just and correct. The necessity for the use of materials in a science course is, from the student's point of view, purely adventitious, and really bears exactly the same relation to his work that the wear and tear on library books, for which no charge is made, does to the work of his fellows in the humanities. The use of these materials is absolutely indispensable to instruction in the sciences, and hence I think it is the duty of an institution to provide them without extra charge as a part of its provision for good instruction. The extra charge always places the student of the sciences at some disadvantage as compared with others. In principle, therefore, I think the extra charge is unjustifiable, and if justifiable at all, it is so only upon the ground of expediency.

TIFIC COMPANY, of Chicago: THE KNY-SCHEERER COMPANY, of New York, and THE HENRY HEIL CHEMICAL COMPANY, of St. Louis. Of firms supplying botanical material, viz. fresh or preserved materials for study, THE CAMBRIDGE BOTANICAL SUPPLY COMPANY, of Waverly, Massachusetts, THE KNY-SCHEERER COMPANY, of New York, and THE WOODS HOLE BIOLOGICAL LABORATORY, of Woods Hole, Massachusetts, are the chief in the East, while the Department of Botany of Leland Stanford University (address G. J. PEIRCE) will supply such material, in season, for the Pacific coast. THE ST. LOUIS BIOLOGICAL LABORATORY, of St. Louis, supplies much preserved material. Most of the seeds needed for laboratory studies can be bought from the regular seed firms which exist all over the country.

## VII. ON BOTANICAL COLLECTIONS AND OTHER ILLUSTRATIONS

THE only sufficient foundation for biological knowledge is laboratory or other practical study. The laboratory method, however, has this inherent defect: consisting as it must in the investigation of a series of more or less isolated topics or types, it gives a view of the plant world which is both discontinuous and deficient in perspective. In order that the full value of practical study may be utilized, these isolated topics or types need to be located, united, and correlated in one general conception, complete and correct as far as it goes. To this end the various kinds of formal instruction, lectures, demonstrations, and so forth, are indispensable; and these I have considered elsewhere in this book. But especially valuable is a comprehensive survey of a large series of connecting forms, and such a survey is rendered possible only by the possession of collections of living plants, of museum specimens, of models, of photographs, or of charts. The study of such collections has no great educational value apart from some actual laboratory study, but every topic thoroughly studied in the laboratory becomes a center of

illumination for a circle of related matters which then have a significance and interest otherwise entirely lacking. A good laboratory course in any science distributes these centers of light within view of one another, so to speak, so that by the use of the other aids, a plain and safe passage can be made from one to the other.

The most valuable of all botanical illustrations are, of course, living plants growing wild in their native homes, and naturally the teacher will make every effort to utilize them through field excursions. But in practice this use of the native vegetation has marked limitations, for not only are some of the most instructive plants residents only of tropical or other distant parts, but the native vegetation is often impracticably distant, especially from schools of the city; while in any case it is not in growth during the greater part of the school and college year. These drawbacks are partially overcome by Botanical Gardens, and especially by their greenhouses, in which the most interesting and scientifically-important plants of all climates are brought together and kept alive, always suitably labeled and ready for study. Such collections of living plants, though of small worth for showing the relations of the plants to their natural surroundings, are invaluable for their illustration of structure, morphology, and classification, and even of some important facts of habit and adaptation. The teacher who is so fortunate as to live within reach of a Botanical Garden should not only make full use

of its collections, but should also, for such profit and pleasure as he may derive therefrom, make the acquaintance of the director.

Botanical Gardens are numerous in Europe, but comparatively rare in this country. We have but three or four of the first rank, which, in order of their age, are, *The Missouri Botanical Garden* (popularly known, locally at least, as *The Shaw Gardens*), at St. Louis, Missouri: *The Arnold Arboretum* (a department of Harvard University, devoted to trees and shrubs only), at Jamaica Plain, Massachusetts: *The Botanic Gardens of the United States Department of Agriculture*, at Washington, D.C.: *The New York Botanical Garden*, at Bronx Park, New York City.

Of lesser size but similar aims are the botanical gardens maintained by several of the leading universities or colleges, notably (in approximate order of age) those of *Harvard University*, at Cambridge, Massachusetts: of the *Michigan Agricultural College*, near Lansing, Michigan: of the *University of Pennsylvania*, at Philadelphia, Pennsylvania: of *Mount Holyoke College*, at South Hadley, Massachusetts: of *Smith College*,<sup>1</sup> at Northampton, Massachusetts: of the

<sup>1</sup> It has been my good fortune to be able to develop this garden, with its unusually fine range of greenhouses, along the lines which have seemed to me most suitable for botanical education. It now represents very nearly my ideal of an efficient equipment for the use of a college. There is a description of its plan, now somewhat antiquated, however, in *Garden and Forest*, 10, 1897, 512. The greenhouses in particular (The Lyman

*University of California*, at Berkeley, California: of the *University of Michigan*, at Ann Arbor, Michigan: of *Johns Hopkins University*, at Baltimore, Maryland: while *Leland Stanford University*, of Leland Stanford, California, has a beginning in an arboretum, and the *University of Minnesota*, at Minneapolis, Minnesota, is about to develop its small garden to a much larger one. Many of the Agricultural Colleges and Experiment Stations have experimental gardens which in some cases approximate towards botanical gardens, and at least two cities maintain botanical gardens of a really scientific character, viz. Buffalo, New York, in the *Buffalo Botanical Garden*, and San Francisco in Golden Gate Park. These genuine botanical gardens (whose distinguishing feature may be taken to consist in a deliberate grouping, as well as labeling, of the plants to illustrate some scientific idea in classification, distribution, or habit) merge without break into certain public gardens, especially those which are provided with conservatories, as in the case of Schenley Park, Pittsburg, and thence downward through others in which the

Plant Houses, a memorial gift) are described, though without some of the latest additions, in *Science*, 15, 1902, 933, while the Physiological Experiment House and Laboratory are described and pictured in the second edition of my *Laboratory Course in Plant Physiology*.

There is an admirable summary account of the greater Botanical Gardens of the world, including those of this country, by N. L. BRITTON in the *Bulletin of the New York Botanical Garden*, 1, 1897, 62, while a symposium on Botanical Gardens from different points of view, is in *Science*, 31, 1910, 641, and a later number.



trees and shrubs are merely labeled as they happen to stand, as in the Public Gardens at Boston.

Where no greenhouses of Botanical, or Public, Gardens are available, the teacher can sometimes make the acquaintance of the owner of a private greenhouse, who will generally be found willing to allow its use for educational purposes, and even may consent to accumulate some of the more interesting plants; for people with the taste for growing exotic plants usually desire to make them as widely useful as possible. And when even this resource is wanting, something can be done with window gardens, which, indeed, when the conditions are favorable, can be made both useful and attractive. Upon this subject I am fortunate in being able to present the following suggestions, written for this book by Mr. EDWARD J. CANNING, the experienced head gardener of Smith College.<sup>1</sup>

The successful growing of plants in windows, especially in a laboratory or schoolroom, requires more care than in an ordinary greenhouse, because of the dryness of the atmosphere, the fluctuations of temperature, the exposure to drafts, and the uneven or one-sided light. Nevertheless, with intelligent and daily attention in the matters of ventilation and watering, good plants can be grown, especially as it happens, by good fortune, that the majority of plants of most value for teaching purposes are generally of easy culture.

<sup>1</sup> There are also valuable articles upon this subject in accessible publications, by J. W. HARSHBERGER in *Education*, 18, 1898, 555; by H. D. HEMENWAY, in a Bulletin of the Massachusetts Agricultural College (may be had on application), and by F. K. BALTHIS, in the *Nature Study Review*, 4, 1908, 276.

The ~~Window~~ Plants do best in windows which face east; ~~they~~ they receive the earliest light of the day, which is best for their food making, while they are exposed to its concentrated rays at midday. For eastern windows blinds are not needed, but for southern and west-  
 facing windows these must be provided (white are best), in order to screen the plants during the hottest part of the day. Windows of a northern aspect are best for ferns and other shade-loving plants. Bay windows are better than ordinary windows, because they admit more light and can generally be more evenly ventilated.

**Ventilation.** — Cold drafts of air are injurious if not fatal to most plants; therefore, air should be admitted with the greatest caution. When it is necessary to ventilate on cold days, air should be admitted sparingly, from the top of the window, so that the plants will not be subject to sudden changes of temperature, one result of which is the development of disease.

**Shelves.** — One good shelf, one foot in width, is all that any ordinary window should have. Cypress boards of about one inch in thickness, and painted, will be found the most durable if wood is used. Zinc trays, of one and one half inches in depth and made to fit the shelves, should be provided. These should be filled to half their depth with either fine gravel or crushed stone, so that the surplus moisture may pass away readily from the pots without running over the floor, while at the same time this arrangement provides for a constant evaporation of some moisture in the air around the plants. The gravel or crushed stone prevents the pots from actually standing in the water, which for many kinds is so fatal to the plants.

**Flower Pots and Boxes.** — Boxes of about ten inches in depth, made to fit the window and filled with soil in which the plants are set out, are often used. They have the advantage that the moisture conditions of the soil can be kept more even, and with much less attention, than in the case of plants grown in pots; but there is a disadvantage in that the plants cannot be moved about as readily. For purposes of study, therefore, pots are, upon the whole, preferable, though for kinds not needing to be moved boxes are better.

**Soil.** — A good fibrous loam to which some leaf mold and sand have been added will suit the great majority of window plants. This can be obtained from the nearest gardener or florist.

**Watering.** — It may not be necessary to water plants every day, but it is necessary to examine the moisture condition of the soil that often. As a general rule, soil should be moist but not saturated, and the more evenly the soil moisture can be maintained the better the plants will grow. In winter, the morning is the best time for watering, and the water should have about the same temperature as the room in which the plants are grown, which can be insured by taking the water not from a tap, but from a vessel kept standing for the purpose near the plants.

**Plants and Seeds and Bulbs.** — Most of the ordinary greenhouse plants may be grown in windows, but for teaching purposes a selection of those best adapted to scientific study should be made. This does not mean a collection of rare plants, but, on the contrary (with the exception of plants used in the study of ecology), the commonest, most easily grown, and most easily obtained from almost any florist. The following are lists of plants which at Smith College we have found best adapted to the various phases of scientific work. All of them may be grown in window gardens, and some of them are very attractive aside from their scientific uses.

**I. Plants well adapted for Experimental Plant Physiology.**

— Abutilon, Begonia coccinea, Cineraria, Cestrum, Coleus, English Ivy, Fuchsia, Garden Nasturtium, "Geraniums" (Common Horseshoe, Lady Washington, Ivy Leaf), German Ivy, Heliotrope, Impatiens, Marguerite, Oxalis Bowiei, Passion Vine, Primroses (*P. obconica* and *P. sinensis*), Rubber Plant, *Salvia involucrata*, Senecio Petasitis, Spiderwort, Wandering Jew.

**II. Plants best adapted for the Study of Ecology.** — Since these plants are not showy, but, with the exception of *Smilax*, are of scientific interest only, they are not grown by the ordinary florist, and can only be obtained from Botanical Gardens or other scientific institutions.

*Acacia cultriformis*, *A. longifolia*, *A. melanoxylon*, *Aspara-*

*gus medeoloides* (*Smilax*), *Carmichaelia australis*, *Casaurina distylia*, *Colletia cruciata*, *Danae Laurus*, *Ephedra distachya*, *Genista sagittalis*, *Muehlenbeckia platyclados*, *Oxalis bupleurifolia*, *Phyllanthus latifolius*, *Hypoglossum*, *Senecio articulatus*, some of the *Cactaceae* and *Euphorbias*.

III. **Seeds excellent for the Study of Germination, etc.** — They may be obtained of almost any seedsman, and can be germinated either in soil or sphagnum moss.

Barley, Buckwheat, Castor Beans, Corn (field), Horse Beans (English), Lupine (White), Morning Glory, Mustard, Garden Nasturtium (dwarf), Oats, Radish, Squash (Hubbard), String Beans, Golden Wax (or horticultural), Sunflower, Tomato, Wheat.

IV. **Bulbs useful for the Study of Flowers.** — These are very attractive as well. They can be grown and flowered in windows, and may be obtained from seedsmen or florists.

*Allium neapolitanum*, *Amaryllis Johnstoni*, *Arisaema triphyllum* (Jack-in-the-Pulpit), *Calla*, *Crocus*, *Freesia*, *Galanthus* (Snowdrop), *Hyacinths* (Grape, Roman, Dutch), *Narcissus* (Paper White, Von Sion single), *Scilla sibirica*, *Tulip* (early single-flowering variety).

V. **Ferns excellent for Study.** — These may be grown in windows, preferably of a north or northeastern aspect, and may be obtained of florists.

*Asplenium bulbiferum*, *Cyrtomium falcatum*, *Dicksonia antarctica*, *Gymnogramma sulphurea* (Gold Fern), *Polypodium incanum*, *Polystichum aureum*, *Pteris cretica albolineata*, *Nephrodium effusum*, *Nephrolepis exaltata* (Sword Fern).

A special kind of educational garden <sup>1</sup> now attaining to much prominence in this country is the school garden,

<sup>1</sup> The grounds of almost any school, and certainly those of any college, can be given something of the usefulness of a botanical garden by labeling the trees and shrubs; and this, indeed, from any point of view, is well worth doing. There are many kinds of labels, though none are wholly satisfactory; but, after much experience, I have fixed upon the following as combining in the optimum degree the merits of legibility, durability, inconspicuousness, convenience, and cheapness. It is of good zinc, about

which may be of any grade from that approaching a botanical garden down to the summer farming of vacant 5 by  $1\frac{1}{4}$  inches, and  $\frac{1}{8}$  inch thick, with two holes at one end as in the figure (Fig. 11); and it can be made at small cost by any tinman. The name is written or printed with a pen, using platinum chloride, five per cent solution, as an ink, upon a freshly sandpapered surface; and the writing



FIG. 11.—A good form of label for trees and shrubs; about  $\frac{1}{4}$  the original size.

turns blacker with time. Better than an ordinary pen is a piece of glass tubing drawn to a smoothed capillary point, and held horizontally. A good label should give the scientific and common names of the plant, its native home, and an abbreviation for the name of the family, as shown by the figure. For trees, the label is bent to the curvature of the trunk at a selected place and fastened horizontally, at about the height of the eyes, by two galvanized iron tacks (two instead of one to prevent sagging) driven through the holes, — a method which is much better than that of a nail at each end, since the expansion of the tree soon pulls these out. For trees under three inches diameter the label should be hung by a loop of wire on a lower branch close to the trunk, while on shrubs it should hang on a convenient outer branch. At the contact of wire and zinc a black substance is released, which tends to run down and deface the writing, but this is stopped if the end of the label containing the holes and wire is turned over backwards. Two holes are better than one as making less wear when the label moves in the wind. The same label can also be used for herbaceous plants if attached to a support of pine or cypress, or to an iron rod stuck in the ground. Since the expansion of the trees and shrubs tends to bury the nails and wire, these must be loosened up every year or two, a matter that is not difficult if a certain time is set aside for it. The platinum chloride ink is rather expensive (costing about \$1.20 per ounce),

lots by city children. Whatever the grade, such gardens are of great value, and must repay many fold their cost, not only in botanical and practical instruction, but in moral influence; and their formation cannot be too highly urged. The details of this subject, however, belong rather with a consideration of the nature study of the lower grades than with the scientific course of the high school and college, with which this book primarily deals; and it must suffice if I give here in a note the references which will enable the teacher to follow up the subject if needed.<sup>1</sup>

and a much cheaper and nearly as good ink can be made thus: 2 parts acetate of copper, 2 of ammonium chloride, 1 of lamp black, and 30 of soft water. There is an excellent account of labels and their use under that word in BAILEY'S *Cyclopedia of American Horticulture*.

<sup>1</sup> There is a book devoted to this subject, *How to make School Gardens*, by H. D. HEMENWAY (New York, Doubleday, Page & Co., 1903). An article by H. L. CLAPP, in the *Popular Science Monthly* for February, 1898, describes a very successful school garden in Boston, and illustrates how much may be accomplished even with limited space and means. Some very practical material is in L. H. BAILEY'S *Lessons with Plants*, and especially in his *Garden Making*; and there is an excellent little leaflet (No. 4 of the Nature Study Leaflets) on children's gardens, published by Cornell University, and an excellent report on school gardens, published by the Massachusetts Horticultural Society in 1900. A highly commended article upon Tree Planting on rural school grounds is published by the government as Farmer's Bulletin, No. 134, while Circular 42 of the Department of Agriculture is also important. In this, as in so many other respects, Europe is much in advance of this country, and German experience is well set forth in a book, *Der Schulgarten des In- und Auslandes*, by B. CRONBERGER, published at Frankfurt-a-M., in 1898 (cost 2.80 marks), while there is also a special United States Consular Report (Vol. 20, Part II, 150-224) on school gardens in Europe, of which there is a good review and synopsis in the *Scientific American*, October 27,

Next in value to living plants are prepared specimens, especially those made to look as much like life as possible. The collection and arrangement of such specimens is the function of museums. Unhappily, there is no known method of preserving plants in their natural forms and colors as is possible with so many animals; though on the other hand it is possible to preserve plants, when pressed and dried, with a cheapness, compactness, and accessibility far exceeding anything possible with animals. Hence it comes about that there are many great collections of dried plants (herbaria) and but few great botanical museums. Even in Europe botanical museums are scarce and of minor interest, and in America there are as yet but two of any account, that of the New York Botanical Garden, at Bronx Park, New York City, which is far in advance of any other in this country, and that of Harvard University, which owes its interest chiefly to the success with which the living plants, including flowers, have been imitated by glass models of the most natural form, size, and color.<sup>1</sup> Most colleges, however, in the course of their

1900, 259. A special study is being made of this subject under the best of conditions by the School of Horticulture of the Handicrafts School of Hartford, Connecticut, and especially by the MacDONALD College of Ste. Anne de Bellevue, Canada, while many articles bearing upon the subject are contained in the volumes of the *Nature Study Review*, a valuable journal of which particulars may be found in the chapter on Books.

<sup>1</sup> This collection of models, the Ware Memorial Collection, was made by LEOPOLD and RUDOLPH BLASCHKA, of Dresden, Germany. It has

educational work, develop small museums, or at least teaching collections, and these are of such value that every teacher, whether of school or college, should aim to possess one. A good specimen, once suitably prepared and preserved for demonstration, is a valuable permanent possession, well worth all the trouble expended upon it.

The hard parts of plants, such as dry fruits, woody stems, skeletons of leaves, and the like, are best preserved dry, as indeed the entire plants themselves may be, in the herbaria of which I shall speak presently. But the softer parts can be kept only in some preservative liquid, though none is known which will keep color well. A solution of four per cent formaline in water will preserve colors as well as any, but it keeps some much better than others, while it allows the important green tissues to become of a translucent unnatural shade, which is hardly worth while.<sup>1</sup> In my own collections I use a mixture of two per

attracted wide attention for its great accuracy and beauty of execution. A full account of it is given by WALTER DEANE, in the *Botanical Gazette*, 19, 1894, 144. One of the curators of the British Museum has said of it, "No other museum possesses anything half so beautiful." It is unique, and by contract with the makers no part of it is to be duplicated.

<sup>1</sup> If one wishes to try to preserve the green color by other methods he may consult to advantage an article by A. F. WOODS, in the *Botanical Gazette*, 24, 1897, 206. I am told by MR. A. E. COLLENS, of the Government Laboratory, Trinidad, that the addition of a small amount of copper sulphate solution to the dilute alcohol or formaline, often aids much in preserving the green color of plants.

Detailed and valuable directions for the use of formaline as a preservative for museum specimens of botanical objects are given by G. E. STONE,



cent formaline in thirty per cent alcohol, which preserves the softest tissues perfectly in every respect except color, which it blanches to a nearly uniform dull white. Formaline is used in such small quantities that it is really very cheap, while denatured alcohol, which is equal to the best for this purpose, is now sold at a price not over one dollar a gallon. The best grade of alcohol, however, may be bought by schools and colleges free of internal revenue tax, though only after somewhat complicated legal formalities; and this privilege reduces its price in quantity to about forty cents per gallon.

The bottles for the preservation and exhibition of specimens may consist of one of the many forms of preserve jars, which have the merit of cheapness; but after considerable observation of the impression produced upon students by the use of such makeshifts, I am convinced that it is true economy to buy only the best bottles,—viz. those made from white flint glass, with ground-glass stoppers,—not only for specimens in liquids, but also for dry objects, such as seeds, which need some protecting vessel. Not only are all specimens thus made permanently safe from evaporation and dust, but the respect of the students is far greater for a compact, artis-

in the *Journal of Applied Microscopy*, 2, 1899, 537, and there is an important article by H. S. REED upon the preparation of museum specimens of plants in the same journal, 5, 1902, 1885. Many practical directions upon the preservation of plant material, especially for laboratory use, are given by F. E. LLOYD in his *Teaching of Botany*, 222,

tically presented specimen than for one in a green leaky jar or a dusty box, and hence its value to him is greater. The teacher, too, is more likely to accumulate only things of value if the receptacles must be economized. For a collection of my own I prefer a dozen such specimens to thrice that number indifferently prepared. I have experimented with several forms of bottles, and finally have fixed upon WHITALL & TATUM'S (Boston and New York) No. 2605 specimen jars, which may be had in all sizes, and for which their published prices are subject to large discounts. I prefer the appearance of these to that of the kinds without a neck, and they are about equally useful. But, of course, if one cannot afford the better grade, some of the many forms of preserve jars will do very well, and are far better than nothing at all. For dry objects, such as seeds or powders, a very satisfactory and inexpensive bottle is the inverted test tube with a wide-flaring mouth serving as a foot, manufactured in two or three sizes by the WHITALL & TATUM COMPANY of New York. A cylindrical cork stopper is inserted at the bottom, and holds a label closely against the glass. Another very excellent and economical container for dry objects has recently been described by G. L. GOODALE.<sup>1</sup> It is made from lantern slide glass attached by glue over a frame of pre-

<sup>1</sup> In *American Journal of Science*, 21, 1906, 451. A somewhat similar arrangement is described by H. L. OSBORN in the *Journal of Applied Microscopy*, 3, 1900, 1053.

pared wooden strips made tight by hard paraffin, the whole being finally secured, on the passe-partout principle, by glued strips. In whatever manner prepared, however, every specimen should be in condition to be handled and passed about. Tight, upright, glass-fronted wall cases should be provided for the museum collection, and it is well to have all specimens very fully labeled and carefully arranged in order that they may be as instructive as possible when not actually in class use. In other words, the specimens should represent not only a collection useful in teaching, but part of a school or college museum of general interest. In any museum collection whatever, the great guiding principle should be selection, not accumulation; and in plan and labeling the famous dictum of GOODE<sup>1</sup> should be remembered, that the modern museum is a collection of labels illustrated by specimens. The teaching collection need have no formal beginning; but as specimens from one source and another are obtained, they should be suitably prepared and added. There are as

<sup>1</sup> There are valuable papers on Museum making, by G. BROWN GOODE, in *Science*, 2, 1895, 197, and 3, 1896, 154, and there is a very elaborate and well-illustrated series of articles on the subject by L. P. GRATA-CAP, in *Journal of Applied Microscopy*, Vols. 5 and 6, 1902-1903. Particularly apposite and most valuable, though I cannot agree with all of its recommendations, is J. M. MACFARLANE'S "The Organization of Botanical Museums for Schools, Colleges, and Universities," in *Biological Lectures delivered at the Marine Biological Laboratory at Woods Holl in 1894* (Boston, GINN & CO.). Of much suggestiveness is BOYD DAWKINS'S address on the Place of Museums, in *Nature*, 46, 1892, 280.

yet no firms in this country offering for sale considerable numbers of museum specimens of plants such as are offered of animals, though there are several in Europe.

The teaching collection should be arranged upon a definite plan carrying out a central idea, for thus the specimens, while losing nothing of their individual value and interest, become elements in the composition of a picture of that subject as a unit. There are two distinct ideas which may underlie the plan of the collection, viz. that of structure-function (leading facts of morphology, including anatomy, and of physiology, including ecology), and that of classification (the groups of plants in their natural relationships from Algæ to Spermatophytes). Since these two ideas represent the two usual points of view of the plant kingdom, it is best, especially in a public museum, that both be represented. The first impression, that this is uneconomical because involving duplication, is not correct, since in fact the structure-function idea involves chiefly selected parts of plants, while the classification idea requires the entire plants. So far as the teaching collection is concerned, however, the best plan, I believe, is to make it correspond with the plan of the course itself, and if, as recommended in the second part of this book, the course comprises both structure-function and classification, then the collection can follow the plan which is best both in principle and practice. Moreover, the physiological appliances, suitably explained by labels, can well form,

when not in use, an integral part of the museum, being inserted at the places answering to their place of use in the course.

Labels are an essential feature of a collection, and they should be neat, permanent, and firmly attached to the

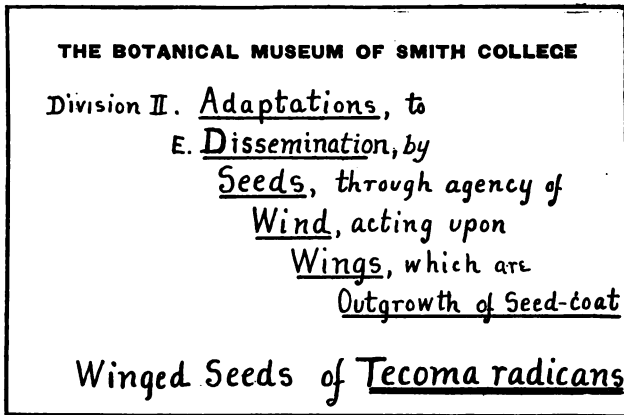

FIG. 12. — Sample Museum Label.

specimens or their bottles.<sup>1</sup> Such attached labels hardly allow room for more than the most indispensable facts, and moreover they are, as a rule, not legible when the specimens are in their cases. Hence it is well to have also a larger exhibition label which need never be taken from the

<sup>1</sup> A glass-stoppered bottle can be easily labeled by writing in pencil upon the ground surface of the stopper; the writing will show clearly through the neck of the bottle. Or the label may be written on the outside of the bottle with waterproof India ink, which should then be covered with a thin layer of Canada balsam, or else with hard paraffin applied hot. If written in pencil, a label may be placed in the liquid with the specimen,

case; this should give legibly the important facts about the specimen, with data to show its place in the plan of the collection. This subject I can best illustrate by the accompanying sample. It is well worth while to have a printed heading, as in the sample, for this is one of the means of promoting that spirit of care, permanence, and pride of possession which is so potent a stimulus to the development of a worthy collection.

Plants may be preserved, as everybody knows, by pressing them between absorbent papers until dry, and then mounting them upon sheets of stiff paper; and a collection of such dried plants is universally known as an Herbarium. Theoretically an herbarium is part of a botanical museum, but on account of the form of the specimens, they are usually kept stored in portfolio-like covers, though sometimes a few of this sort are displayed like pictures behind glass. For a thorough knowledge of the flora, that is, the species of plants collectively, of any region, an herbarium of the usual systematic type is simply indispensable; but in a teaching collection it has less utility. But the question arises whether the ease of preparation, cheapness, and compactness of the herbarium method cannot be utilized in the formation of a collection to illustrate a part at least of the facts ordinarily taught in a general course, especially the facts of morphology, adaptation, and the forms of plants in the different groups. I have myself experimented a good deal upon this subject, with the conclusion

that an herbarium of the greatest usefulness can be developed upon the plan outlined above for the teaching collection; and indeed I am inclined to believe that where means, room, or policy do not admit of exhibition cases, or where the collection is the personal property of an individual and needs to be easily transported, the herbarium upon this plan may actually be superior to the museum. Every specimen, of course, should be selected to illustrate some fact, and only that part of the plant ought to be used which displays it, while each sheet would illustrate not a species but an idea. Drawings, descriptions, and photographs may be incorporated with an herbarium more conveniently than with a museum, and it is also possible to add many objects in envelopes, flat boxes, or even small bottles attached to the sheets, which offer, incidentally, ideal opportunities for good labeling. An obvious drawback to the herbarium, that its specimens are not adapted to exhibition, can be overcome by a method of which mention has already been made, viz. placing the sheets under glass in frames and hanging or otherwise using them like framed pictures. The frames should be hung by screw eyes upon hooks in the wall so as to be readily taken down, and if the backs are easily removable, the sheets may frequently be changed to accord with the topics under study by the class. In my own laboratory there hangs a series of some thirty such frames, containing sheets in illustration of the principal facts of

external morphology and adaptation; and they prove not only valuable for instruction, but are of much general interest as well. A photograph of two of the sheets is given herewith (Plate II). Instead of the somewhat heavy glass and frames one may use transparent celluloid (or xylonite), bound, by means of adhesive paper tape, on the passe-partout principle, to a back of stiff cardboard, such as photographers' mounting cards.<sup>1</sup> Such preparations have the advantage over the frames of greater safety and convenience when passed around the class, and moreover, they may be made in any desired sizes, even to including single small objects, and may very readily be incorporated into the museum, or even the herbarium, collection.

The usual herbarium methods are those to be used in the preparation of the teaching or exhibition herbarium. In drying the specimens the object is to extract their moisture as rapidly and perfectly as possible without allowing them to curl or crinkle. To effect this the plants are first arranged in thin, porous specimen sheets which are then placed between layers of absorbent driers (i.e. special blot papers, blotting papers, or even newspapers), and these driers are then changed in order as practicable. — at least

<sup>1</sup> The method is described by W. H. Harvey in *Journal of Science*, p. 100, and also fully in his *Teaching of Botany*, etc. The same principle, but with a different material of celluloid, is employed in the *Practical Botanical* Manual prepared in 1902 and ready for use by The Western Port Commercial Company, 20, Queen Street, South.





PLATE II. — Sheets from a teaching (exhibition) herbarium;  $\times 2$ .



twice a day for the first two days and once a day until the plants are dry. In general the faster the drying the more natural is the appearance of the resulting specimen, especially as to color. Meanwhile the plants are kept under pressure (applied either by screw or other presses, or by boards and weights), which should be as great as the tissues will stand without being crushed, and which, therefore, should be increased as they become drier. Such is in brief the principle of the older method, but in recent years, in order to expedite the drying, it has become usual to employ artificial heat, which is applied either through open-work or wire presses, through hollow metal cylinders to which the specimens are kept appressed, or through the passages of corrugated papers between which the plant is embedded in layers of cotton wool. I can hardly take space to describe these methods in particulars, or the details essential to the best success in the use of the older ones; but happily they are all discussed in publications which are readily accessible, as will be seen in the note which I give below.<sup>1</sup> The mounting of the specimens

<sup>1</sup> The fullest account of the older herbarium methods is contained in W. W. BAILEY'S *Botanizing* (Providence, Preston and Rounds Co., 1907), but there is also an admirable summary of the whole subject in GRAY'S *Structural Botany*, Chapter X, Section 4, and in the Herbarium number of the *Botanical Gazette*, 11, June, 1886, while many valuable directions, based upon an unusually successful experience, are in W. DEANE'S "Notes from My Herbarium" in the *Botanical Gazette*, 20, 1895, 12, 150, 345, 492, and 21, 1896, 210. There is an account of some of the methods used at the Gray Herbarium, by B. L. ROBIN-

offers no difficulty; they are simply glued by their least useful side to sheets of thick paper or cardboard, after having been poisoned, if the utmost security is desired against injury by insects. Herbaria have been made so long and in such numbers that the appliances and materials, as well to some extent as the methods, have gradually approached a condition of standardization; and the standard driers and mounting papers, as well as collecting appliances and presses, are now sold by most dealers in biological supplies, while they are a specialty of THE CAMBRIDGE BOTANICAL SUPPLY COMPANY, of Waverly, Massachusetts. The corrugated paper press is sold ready for use, under the name of RIKER'S press, by THE HENRY HEIL CHEMICAL COMPANY, of St. Louis, Missouri.

Another phase of herbarium-making which will here recur to the mind of the reader, is its requirement by many teachers from their students as a regular part of the work of their course. I have already discussed this subject from the educational point of view in the earlier section on teaching, and would only make at this place a single recommendation,—that if an herbarium is required, it should be formed upon some such plan as that of the

SON, in *Rhodora*, 5, 237, 1903. A note giving HENNINGS'S method of preserving the colors of flowers is in the *Annals of Botany*, 1, 1887, 178. The new hot cylinder method of drying is described by S. ROSTOWZEW in the German Journal *Flora*, 88, 1901, 473, and there is a synopsis of this article in *Torreya*, 1, 1901, 145; while the corrugated paper method is described by W. A. KELLERMAN, in *Science*, 27, 1908, 69.

teaching herbarium just described rather than upon the usual floristic plan.

In making herbaria, whether for the teaching collection or by the students as a part of their course, most teachers require the standard size of mounting paper, the regular genus covers, etc. But while this size ( $16\frac{1}{2}$  by  $11\frac{1}{2}$  inches) is very convenient in large herbaria provided with suitable cases, one or two hundred of such sheets make a package very awkward to store amongst a student's other effects, and not easy to consult on small, crowded tables. This objection can be overcome if the sheets are reduced to the size of a large book and kept stored among books. This I have found to be entirely practicable, and so advantageous that I have adopted it for a small private collection of my own, even in the presence of the best of facilities for storing the larger size. Sheets one half the usual size will hold most specimens, especially if collected on the teaching-herbarium plan, while specimens too large for such sheets can be treated precisely as are those too large for the ordinary size. The specimens are firmly glued to the half (or somewhat smaller) sheets, which are then placed between those covers used in colleges by students for holding any number of sheets of paper, and held by paper fasteners. The thickness of the specimens is compensated by extra strips or stubs; and additions and rearrangements may be made with great ease. The collection is then practically a book, and

may be kept among books. If it be thought that specimens so kept are particularly subject to collection of dust and to insect ravages, it must be remembered that they are no more exposed than they are in the usual condition in which beginners keep them, and that if one cares, he may keep these books closely enwrapped in paper, or even in the usual tight tin cases. It is sometimes said in favor of the standard size that if a student continues his studies, his collection will form a nucleus for his larger herbarium; in such case, however, the specimens can readily be transferred to the larger sheets.

The teaching collection, whether museum or herbarium, must include a good many anatomical preparations to illustrate plant structures, especially plant tissues. Most of these will be prepared and added to the collection by the teacher or his students; and specimens of this origin, when well made, exceed in value any that can be bought, for they involve a thoroughness of knowledge of the object, together with associations of loving effort and personal devotion, which the purchased ones must lack. But when time, skill, or conviction as to the superior worth of the home-made kind, are wanting, some preparations should be bought. Thus, wood sections, beautifully prepared and mounted in book form to show the three principal sections of all the leading North American woods, with accompanying descriptive text, are sold by R. B. HOUGH, of Lowville, New York. A beautifully-prepared series of North

American Algæ, mounted in book form and fully labeled, is sold by F. S. COLLINS, of Malden, Massachusetts, while sets of Fungi have been sold by several persons. Of much importance are microscopical preparations showing fundamental facts of plant anatomy, and also the structure of the microscopic kinds of plants. It is well to have a somewhat wide range of these for demonstration and for voluntary study by those whose tastes incline them thereto, and it is also desirable to have some sets for regular use in the class work, as suggested in places in the second part of this book. In the case of some important topics in which the preparation of material involves unusual difficulties, *e.g.* in cell division or in the reproductive stages of some low plants, it will probably pay the teacher to purchase, rather than to attempt to make, the slides. Sets of botanical slides are sold by most dealers in biological supplies, but sets especially prepared for botanical instruction are sold by the ST. LOUIS BIOLOGICAL LABORATORY, St. Louis, Missouri, while suitable cases for their storage are sold by all dealers.

Next in value after living plants and prepared specimens should come, theoretically, good models. But in actual practice models are mostly inferior to good pictures, in part because of their relatively much greater expense, and in part because the art of model-making with fidelity to nature is far behind the art of picture-making. There is also an objection of another sort to the use of the commonest kind of models, *viz.* those huge representations of

familiar flowers made in papier-maché and arranged to be taken apart to show the interior parts, for they usually impress students as so grotesque a parody on nature, that their use, with me at least, conduces more to the amusement of a class than to its instruction. Moreover, they seem to me to savor of over-refinement of illustration. To use such elaborate methods to illustrate facts which, with but little effort, one can see for himself, is not only to carry a good method over the bounds of the useful into the field of the absurd, but is making illustration enervating rather than stimulating. These objections apply, however, to models of familiar and easily-seen objects, but not at all to enlarged models of minute and unfamiliar subjects, such as stages in embryological development; nor do they apply to such thoroughly artistic models as the WARE collection of glass models of flowers at Harvard University, of which mention has already been made.<sup>1</sup>

The principal makers of models of plants are R. BRENDEL, of Berlin, Germany, who makes a large series in gelatine, papier-maché, and wood: Docteur AUZOUX and LES FILS D'ÉMILE DEYROLLE, of Paris, both of which firms offer a miscellaneous series: and P. OSTERLOH, of Leipzig, who makes a series of models of fungus parasites. THE KNY-SCHEERER COMPANY, of New York, makes a specialty of the importation of models as well as charts. A few anatomical models of stomata, arranged to open

<sup>1</sup> On page 151 of this book.



and shut, of spiral vessels, etc., have been offered for sale, but no firm has yet made a specialty of their manufacture. Models to show the working of the mechanisms aiding to secure cross pollination have been constructed, but not, so far as I know, offered for sale.

Next in illustrative value come pictures, which may be classified into two groups, viz. photographs and wall charts. Good photographs, appealing vividly to the mind through the eye, find their special value in the representation of botanical phenomena in the large, such as the general topography of masses of vegetation in different climates or habitats, or the appearance of foreign plants in their native homes. In the exhibition of details of structure they are, as a rule, inferior to wall charts or other drawings. Photographs, like specimens, have their greatest value when made expressly for their object by teacher or students, but the many good ones which may be bought, or begged, are not to be ignored. Recently very good collections of photographs of vegetation have become available in standard publications, notably in SCHIMPER'S great work, *Plant Geography on a Physiological Basis*, and especially in KARSTEN and SCHENCK'S remarkable *Vegetationsbilder*, both of which are further mentioned in the chapter on Books. The great defect of photographs as class illustrations is the impossibility of showing them to a large number of students at once, yet this is necessary at the time when photographs are most

used, viz. when the larger aspects of vegetation are under consideration in lectures or demonstrations. This difficulty is overcome when they are transferred to lantern slides and projected upon a screen with a stereopticon. Lantern slides, now made universally in a standard size, of 4 by  $3\frac{1}{4}$  inches, are easily prepared by any one at all proficient with photography, and large numbers, mostly, however, of anatomical subjects, and copied from various standard works, are offered for sale by dealers in stereopticons or biological supplies. A particularly useful set, mostly from original sources, and showing vegetation especially, is offered by the ST. LOUIS BIOLOGICAL LABORATORY, of St. Louis, Missouri. Stereopticons are now so well made by so many different dealers that it is needless to particularize. The kind using the electric arc light is much the best, because it permits the pictures to be seen clearly in a room only partially darkened. The best screen is a smooth white wall. The advantage of the stereopticon is great, and it will certainly pay the teacher to obtain one, with a collection of suitable slides, though the outfit is to be regarded as among the desirable rather than the essential features of botanical instruction.

A stereopticon permits also of other illustration. Thus a microscope may be substituted for the projection lens, and various microscopical objects of not too minute a character, including even the exhibition of moving pro-

toplasm, may be shown upon a screen, though not at a great distance. Moreover, some physiological phenomena can also be exhibited in progress,<sup>1</sup> though the preparation for these, like the use of the projecting microscope at all, is so time-consuming and otherwise troublesome, that no one should undertake it unless he has unusual facilities and a taste for that particular kind of work. Some makers (*e.g.* WILLIAMS, BROWN & EARLE, of Philadelphia) also supply a special projecting lens, called a mediascope, useful for projecting small, though not microscopic, translucent objects, such as cross sections of stems, or small transparent animals. Very practicable and useful is the recently-introduced instrument, now sold by dealers under various names (reflectoscope of A. T. THOMPSON & COMPANY, of Boston: episcopes and epidiascopes of CARL ZEISS, of Jena, Germany, and the similar instrument of E. LEITZ, of Wetzlar: balopticon of the BAUSCH & LOMB OPTICAL COMPANY), which projects the images of solid opaque objects, such as pictures in books, or small apparatus, directly upon the screen, and which has only the drawback that its range or distance of action is much more limited than that of the ordinary stereopticon. Finally, the principal dealers are now supplying a combination projection apparatus in which either projection lens,

<sup>1</sup> The various kinds that may be shown, and the methods to be used, are described by W. PFEFFER in the German Journal *Jahrbücher für wissenschaftliche Botanik*, 35, 1900, 711.

microscope, mediascope, or reflectoscope may be swung quickly into place before a powerful electric light, thus permitting of the easy and rapid transition from one to the other of these forms of illustration.

The second class of illustrative pictures includes wall diagrams, whose value consists in the clearness with which they may be made to exhibit the details of plant structure. So widely is their educational worth appreciated that many sets have been published, and are for sale at reasonable prices, which are here quoted on the duty-free basis for schools and colleges. Of sets devoted to the general subjects of the elementary course, — anatomy of the higher plants and life-histories of the lower, — the most useful is the KNY series, published by Paul Parey, of Berlin, of size 69 × 85 cm., 100 in number, with explanatory text, costing about \$96 unmounted, while a second series of much larger size, 100 × 150 cm., is now in progress of publication, at a cost of about \$2.40 each. The teacher should make every effort to secure this very satisfactory series, the first in particular. He should also obtain them mounted on cloth; the price is higher but worth while because of their greater durability. Another and older series of somewhat similar scope is the DODEL-PORT, published by J. F. Schreiber, of Esslingen, a little larger than the KNY series, 42 in number, costing about \$26. Another series now in course of publication is the "Tabulæ Botanicae," published by Gebrüder Bornträger of Berlin, 100 × 150 cm. in

size, of which 5 have so far appeared, costing \$7.50 unmounted. Of sets devoted to classification and ecology, there are three. The most useful is the PETER series, published by Fischer, of Berlin, 50 in number, of size 70 × 90 cm., costing about 75 cents each, unmounted. Next is the JUNG series, published by Fromman and Morian, of Darmstadt, 40 in number, about 100 × 75 cm., costing 90 cents each. Finally comes the KOHL series, published by E. Nägeli, of Stuttgart, of which 16 have appeared, of size 85 × 115 cm., costing \$1.25 each. For illustration of physiological phenomena there are two series, that of ERRERA and LAURENT, published by H. Lamertin, of Brussels, 15 in number, in size 70 × 85 cm., with explanatory text, costing about \$15 unmounted, a very useful and satisfactory series, and that of FRANK AND TSCHIRCH, published by Paul Parey, in Berlin, 60 in number, of size 65 × 98 cm., with explanatory text, costing about \$54. An economic series, illustrating commercial botanical products, is that of HASSACK, published by A. Pichlers Witwe and Sohn, of Vienna, 16 in number, 63 × 95 cm., costing 50 cents each, and there are sets of agricultural charts by ORTH of Berlin, of Plant Diseases, by VON TUBEUF, of Munich, and of Bacteriology by MIGULA, of Karlsruhe. Several sets have also been published in this country, but so far as my knowledge of them goes, the drawings seem to me inferior to the foreign series. There is also a series of large micro-photographs by S. F. TOWER, sold by Ginn and

Co. of Boston, at a cost of \$2.75 each. All of these sets may be imported through any dealer in foreign books, and their importation duty-free (the duty is twenty-five per cent) for schools, is a specialty of **THE KNY-SCHEERER COMPANY**, of New York, from whom descriptive catalogues and details as to prices may be obtained.

Wall charts made by the teacher or students have somewhat the same kind of superiority over purchased ones, as have home-made specimens and photographs, but with this difference, that the wall charts are relatively much more difficult to make well. Several methods for preparing them are in use. The best paper is architects' drawing paper, which is thick and backed with cloth, though it is expensive; but I would here express the opinion that a few on such material, with the enforced care and forethought, are worth many of a cruder sort. Other less expensive materials which have been recommended are white curtaining, or "printed" muslin, or black pattern paper, or strong manila paper, or cardboard. The drawing may be done by water colors, or by draughtsman's colored inks, or by colored chalks, or by black crayons, of which the marks are afterwards fixed by a spray of weak gum arabic, or by paraffined crayons, which may be bought (as prepared for marking upon glass, boxes, and so forth), or may be made at home by immersing ordinary colored crayons in melted soft paraffin until the bubbles cease to come off. Certainly very good charts may be

prepared by these methods, as those who have tried them attest.<sup>1</sup> Such charts may either be kept flat or, when of the larger size, rolled upon attached cylindrical sticks, with flat strips at the other extremity.

The best method known to me for hanging charts while in use is that already described and figured (p. 119 and Fig. 5). For their storage it is an advantage to have them all of one size, and the larger KNY size (100 × 150 cm.) is best if they are to be mounted on rollers, but the smaller size (69 × 85 cm.) is best if they are to be kept flat. The size adopted must depend, however, largely upon the distance at which they are to be viewed, and, therefore, to some extent upon the size of the class. There has been a marked tendency of late, among the publishers of charts, to increase their size. If mounted upon rollers, which are labeled on the end, the storage is easiest, for they may be kept in very simple racks needing a minimum of room. Next in convenience would come the use of slide shelves or shallow drawers, on which they could be laid flat, and yet be readily accessible. This method, however, is wasteful of ground space, and a much more economical arrangement from this point of view is a shallow upright case built against the wall, as

<sup>1</sup> The details as to the use of these methods are given by J. W. HARSHBERGER in *Education*, 7, 1899, 493, and by several writers in the *Journal of Applied Microscopy*,—by F. D. HEALD, in 3, 1900, 1059; by O. HOWARD in 4, 1901, 1172; by C. E. BESSEY, in 4, 1901, 1195, and by MARTHA TRACY in 6, 1903, 2114.

shown by the accompanying figure (Fig. 13). Its bottom is about a foot above the floor, and the front is hinged, so as to drop forward a few inches at the top, when it is caught and held by a side chain.

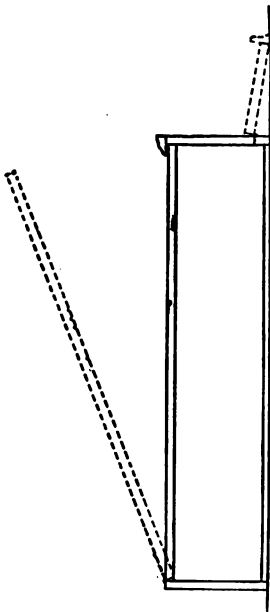

FIG. 13. — A successful box for storage of diagrams, in cross section. The dotted lines show it open. Scale, about 1 inch = 1 foot.

The charts then fall forward upon this cover, and are easily worked over and withdrawn. The great drawback to its use consists in the fact that the charts, unless very stiff, have a tendency to sink down and bend under their own weight; but this can be overcome by the use of a suitable portfolio to each dozen charts.

In this chapter, and the one which precedes it, I have given account of a great many things which are much to be desired for the botanical laboratory, as well as elaborate plans for the construction of the laboratory itself. Such completeness of facilities may seem to my readers too much to expect, and well-nigh impossible to attain. But there is one thing about it all that I can assure him, which is this: it is much easier for us Americans to obtain fine laboratories and equipment than to make good use of



them afterwards. As a people we are over-trustful of the efficacy of machinery, a profusion of which we are prone to confound with progress. The work of the spirit is done not by the like of graven stone, and polished wood, and shining brass, though these things may be made to help, but only by the living word straight from the heart of a devoted teacher.

## VIII. ON BOTANICAL BOOKS AND THEIR USE

THERE is a saying of AGASSIZ still often quoted: "Study Nature, not books." This warning was needed when AGASSIZ gave it, but conditions have changed for the better. Men study Nature more than they did, and books worth reading are more plenty than they were. So I think a wiser maxim for scientific conduct in our own day is this: Study Nature and books.

Books are storehouses of knowledge, and contain almost everything that any one can desire to know, but they exist in such numbers that it is well-nigh an art in itself to find in them the things that one needs. A knowledge of botanical books, and of ways to use them with profit, is, therefore, an important element in the education of both teacher and student. For the purposes of the teaching botanist, books fall into three classes: those to be read for self-improvement, those for reference, and text-books for class use.

In the preceding chapters I have tried to make clear the principal aim of science teaching, which is the cultivation of the scientific habit of mind to the end that a scientific instinct may become a part of the student's mentality. No teacher who lacks this scientific habit of thought can develop it in others; and, other things being

equal, that person is likely to be the most successful teacher who has it in the highest degree. Self-improvement in this respect is, therefore, a first duty of every teacher. The ideal way to this end lies through original investigation, but as this is not always practicable, the best substitute is found in the reading of good books, especially such as are recognized as models of scientific exposition. In reading a book for this purpose, however, it is no real use to skim it for its facts or its rhetoric, but the reader must enter minutely into the spirit of the work, try to put himself into the mental attitude of the writer, view as he does the original data, follow him as he marshals these into their final relative positions, and even try to anticipate him in the deduction of his conclusions. This deliberate method of reading needs emphasis because the conditions of modern life force much hasty reading upon us. Every person aspiring to keep in touch with progress must spend his few minutes a day on the newspaper, his hour a week on his favorite literary review, and some time upon the new magazines and books. It is essential and desirable that we all develop the useful arts of skimming the substance from much printed matter, and of learning from headlines, tables of contents, and pictures; but we should guard against loss of the capacity and the inclination for that critical, absorptive, thorough reading which is educational rather than informational. It is a good rule to have always on hand some piece of reading of this thorough kind.

Turning now to the books which are worth reading in this way, books to be read for self-improvement, we find some, though none too many. Upon the general subject of scientific education and the place of the sciences in education, there is nothing to equal the various addresses of HUXLEY, which are remarkable for their combination of scientific and educational acumen with a forceful and graceful literary style. These are all brought together in his *Collected Essays*, of which his *Science and Education* will be of most interest and profit to the botanical teacher. With these one associates the addresses of President ELIOT, whose influence upon scientific education in this country has been profound, and whose writings, collected into several valuable volumes, are unsurpassed in the force of their presentation of educational problems. Among books which are recognized as models of scientific argument, the first place would be accorded by common consent to DARWIN'S *Origin of Species*, a work which the teacher will also find it well to read in the hope of understanding something of the causes of the profound effect it has had upon the course of biological and philosophical thought. But it is not easy reading and needs to be read more than once, while its real greatness stands out only when the work can be projected against a large background of biological and other knowledge.<sup>1</sup>

<sup>1</sup> As evolution is a particularly fitting subject for the teacher to study for self-improvement, I may here mention the more distinctive books on

Of botanical biography, travel, and essays, there are some good books. Among them one thinks first of the two biological biographies, *The Life and Letters of Charles Darwin*, by his son, FRANCIS (with its important supplementary *More Letters of Charles Darwin*), and *The Life and Letters of Thomas Henry Huxley*, by his son LEONARD, both of which rank among the great biographies of literature, and invite the most careful reading. Of botanical essays some of the best are those of ASA GRAY, collected in his *Scientific Writings* (particularly in Vol. II); they deal with many subjects of general as well as special botanical interest, and, like all of his writings, are clear and graceful in style. From this point of view one may almost include here SACHS'S book, *Lectures on the Physi-*

the subject. These would be DE VRIES, *Species and Varieties, their origin by Mutation* (Chicago, Open Court Publishing Co., 1905) and his *Mutation Theory*, translated by J. B. FARMER and A. D. DARBISHIRE, of which Vol. I has been published by the Open Court Co. WEISMANN, *The Evolution Theory*, translated by J. A. and M. R. THOMSON (London, Edwin Arnold, 1904, 2 vols.). PACKARD, *Lamarck, The Founder of Evolution, his Life and Work* (New York, Longmans, Green & Co. 1901). BATESON, *Mendel's Principles of Heredity* (Cambridge University Press, 1909). The two best discussions of evolution in general are OSBORN, *From the Greeks to Darwin* (New York, the Macmillan Co., 1899), and ROMANES, *Darwin and After Darwin* (Chicago, Open Court Publishing Co., 1892-1897, 3 vols.). Very important also are two new books of addresses connected with DARWIN'S Centenary, viz. *Darwin and Modern Science*, edited by A. C. SEWARD (Cambridge, University Press, 1909) and *Fifty Years of Darwinism* (New York, Holt & Co. 1909). A standard book on scientific method, but one not easy to read, is PEARSON'S *Grammar of Science* (New York, The Macmillan Co.).

*ology of Plants*, which, although primarily a text-book, and unfortunately now much out of date, is a model of clear and attractive exposition of its material, well worth reading from cover to cover, while his *History of Botany* is also a work of great force and value. Of a much less technical character are the pleasing essays by GEDDES, in his *Chapters in Modern Botany*, as well as some of the works of Sir JOHN LUBBOCK, notably his synoptical *Flowers, Fruit, and Leaves*, while a good little book of physiological essays is ARTHUR and MACDOUGAL'S *Living Plants and their Properties*. The great work of KERNER, his *Natural History of Plants*, a superbly-illustrated and attractively-written work, really belongs in this class, in which also I would place some of the writings of L. H. BAILEY, notably his *Survival of the Unlike*, which contains many botanical essays with evolutionary bearing. Here also belongs a most attractive work of biological biographies, LOCY'S *Biology and its Makers*, which should also be placed before all students. Of books of travel there are several, of which the most famous is DARWIN'S *Voyage of the Beagle*, while two by WALLACE, his *Malay Archipelago* and his *Tropical Nature*, are worthy to rank with that work. These, with some others which I mention in a note,<sup>1</sup> deal with animals much more than with plants,

<sup>1</sup> Works of a reputation so high as almost to rank them with the classics of Botany, though not easy to read except by those with tropical experience, are BATES'S *Naturalist on the Amazon* (London, J. Murray, 1892),

but are not the less valuable to the botanist on that account, for Botany does not exist to itself alone. All of the books I have mentioned have proven their value by taking a recognized place in scientific literature, and thus stand in contrast to the many others which have had their vogue and have passed. Taken as a whole, there is no question that the literary aspect of scientific botanical literature is conspicuously weak, and herein lies a field for service not inferior in dignity and difficulty to anything open anywhere in educational effort.

In connection with works to be read for self-improvement one thinks naturally of the botanical journals, as the medium through which one keeps in touch with botanical progress. New botanical books of general interest are, of course, reviewed in the literary journals, and it is becoming more and more the good custom for the leading illustrated magazines to publish articles upon new botanical

and BELT'S *Naturalist in Nicaragua* (London, E. Bumpus, 1873). A recent book of the same type is SPRUCE'S *Notes of a Botanist on the Amazon and Andes* (London, the Macmillan Co., 1908, 2 vols.). Another, of altogether unusual interest as a narrative, aside from the high value of its observations, is FORBES'S *Naturalist's Wanderings in the Eastern Archipelago* (London, Sampson, Low & Co., 1885). To these I would add two books by W. H. HUDSON, which, while almost exclusively zoölogical, are in my opinion quite unmatched for their combination of clear scientific description and attractive literary form, his *Naturalist in La Plata* and his *Idle Days in Patagonia* (London, Chapman and Hall, 1892 and 1893). If one would read an attractive book in German, describing the travels of an expert modern botanist, he will find it in HABERLANDT'S *Eine botanische Tropenreise* (Leipzig, W. Engelmann, 1893).

discoveries, especially such as have economic applications; and thus the teacher may keep informed to some extent through these sources. The most important journal, however, one which gives botanical news, reviews, addresses, occasional articles, along with similar matter for the other sciences, is the weekly newspaper *Science*, and the teacher should arrange to see it every week. The corresponding and much older English journal, which it is also very advantageous to follow, is *Nature*. The leading botanical journal of this country is the *Botanical Gazette*, the principal articles of which are mostly too technical for the use of teachers, though the briefer articles, minor notices, and notes for students, while intended for a somewhat advanced audience, are simply invaluable as synopses of botanical progress. Another prominent journal is the *Bulletin of the Torrey Botanical Club*, which leans strongly towards classification, but has some articles of general interest, together with a distinctive monthly index to all American botanical literature; while it is supplemented for general news, reviews, and so forth, by the journal *Torreya*, issued under the same management. Another journal devoted to classification, especially of the flora of the north-eastern United States, is *Rhodora*. But as to a journal for the teacher and general reader, we have as yet none that even approaches a satisfactory character, and the lack of it is another illustration of the weakness of



this science on the literary side. Such a journal should be accurate in its fact, literary in its tone, artistic in its dress, and comprehensive in its scope, — having departments of leading articles, contemporary discoveries, educational advances, editorial comment, reprints of botanical classics, book reviews, biographical and other news; and it should cover these subjects so systematically that nothing of consequence would be missed, and no teacher or other person of botanical interests, could afford to go without it. The most prominent of the popular journals now existent is the *Plant World*, which is notable for the authoritative quality of the articles of which it almost entirely consists, and this is true also of the English journal, *The New Phytologist*, which, however, is somewhat more technical in character. Another, which publishes miscellaneous botanical notes, etc., is *The American Botanist*. A good journal devoted to the teaching of the sciences, and including excellent occasional botanical articles, is *School Science and Mathematics*, while the *Nature-Study Review* contains valuable botanical material, along with its other good matter. Further information about the place of publication and price of these journals will be found in the Bibliography at the end of this chapter.

The reader who has followed this chapter thus far may sometimes have wondered how I expect that people with resources so small as those of most teachers of Botany can hope to command so many expensive journals

and books. Certainly it cannot be done through purchase and subscription by the individual, though some books, those to be most carefully read, the teacher should himself possess. But nearly all schools have a library of some sort, while most teachers are now in touch with a public library; and the teacher should urge the purchase of these books, and the taking of some of these journals, by one or the other. The teaching botanist, in fact, should be the local authority upon what is best in botanical literature, and should courteously but firmly insist that the libraries provide it. And this will be the easier from the fact that all librarians welcome exactly this kind of interest and advice.

We pass now to the important matter of reference books, which have several values for the teaching botanist. They are sources of information when new questions arise, stores of illustration and material for fuller study of particular topics, and treasuries of suggestion to such of the better students as take pleasure in working through them. They should always be accessible in the laboratory, and students should be taught the valuable habit of consulting scientific literature by following up through the indexes the topics that interest them. At the same time the teacher must remember, and the students be taught, that all such books are to be used with some caution, partly because of their unavoidable human equation of error, and partly because even the best of them are soon left behind

by the ceaseless advance of Science, and in time become antiquated or obsolete unless superseded by later editions. The difficulty is not that most of their matter is incorrect, but that only an expert knows what is to be trusted and what not. Books become superseded, of course, more quickly in some divisions of the science than in others; but, in any case, it is essential that the newest editions of standard works be obtained as they appear, and this is the more worth while since later editions are likely to be improved in other respects besides newness of information. One always experiences a pang of regret in removing from the list of books of present value, any which have been works of mark and merit in their day; but this is a part of the price of progress. In the preceding part of this chapter it has been possible to omit all works except those which appear to remain of permanent value, but in the part to follow, I must make mention of some which have been in use within our own day, or have had a part in our own education, but which have since become obsolete or superseded.

For our present purpose reference books may conveniently be classified in agreement with the divisions of Botany now commonly recognized in general courses and adopted in this book, viz. Morphology including Anatomy, Physiology including Ecology, and Natural History including Classification. Upon the descriptive morphology of the external parts of the higher plants, that phase of

the science which stands in the minds of most persons as morphology par excellence, a work of undisputed pre-eminence is GRAY'S *Structural Botany*, a very clearly-written, and well-illustrated book, the nature of whose subject makes it still a standard work. But while its statements of fact are irreproachable, its interpretations of morphology are of a formalistic or mechanical kind now rendered obsolete by later researches, a matter which is discussed in the final chapter of Part I of this book. The present great standard work upon the external morphology of the higher, with some of the lower, plants, is GOEBEL'S *Organography of Plants*, a very comprehensive and stimulating book; to a certain extent it supersedes his earlier well-known work, *Outlines of Special Morphology and Classification*, which, however, is well-nigh obsolete for need of revision. The present trend of morphological study correlates external and internal morphology more closely, and this newer view is embodied in the two important works of COULTER and CHAMBERLAIN, their *Morphology of Gymnosperms* and *Morphology of Angiosperms*. As to internal morphology, which, so far as it concerns the tissues, is now commonly called anatomy, and as it concerns the cell protoplasm, is called cytology, DE BARY'S almost classical *Comparative Anatomy of the Phanerogams and Ferns* is still useful; but a more modern work from a somewhat different standpoint is SOLEREDER'S systematic *Anat-*

*omy of the Dicotyledons* (presumably to be followed by another on the remaining higher plants). These works are very elaborate, and fortunately we possess a recent and very excellent synopsis of the subject in STEVENS'S *Plant Anatomy*, a work especially adapted to the uses of a teacher in a general course; and there is also a good briefer presentation of this subject in CURTIS'S *Nature and Work of Plants*, and a particularly authoritative treatment by STRASBURGER in his *Text-book of Botany*. For the practical laboratory study of anatomy, we have one of the greatest of all works connected with botanical education, and one of the few books which forms a good guide to self-education, in STRASBURGER'S *Hand-book of Practical Botany*, while our best, and that a very excellent, work upon practical methods in anatomy and cytology is CHAMBERLAIN'S *Methods in Plant Histology*.

In following this discussion of books the reader will note that I do not make clear distinction between books for reference and text-books. But it is a fact that the text-books of advanced courses serve often as the best of reference works for lower grades, while it occasionally happens that a work which one teacher would use as a reference book in the general course is used by another as a text-book. I can, however, but present them all as they look to me from our present standpoint, leaving each teacher to make choice in accord with his judgment and local conditions.

Turning next to Plant Physiology, we find first of all a standard work of the very highest rank in every respect: PFEFFER'S monumental handbook, *Physiology of Plants*. But although invaluable for reference, especially for advanced workers, it is difficult to read consecutively, and the best reading work, one of great excellence in every respect, is JOST'S *Lectures on Plant Physiology*. This work is of the scope, and may be considered to supersede, the books of nearly the same title by SACHS and by VINES, works great in their day but now far behind the state of our knowledge. Briefer presentations of the subject are GREEN'S *Introduction to Vegetable Physiology* and PEIRCE'S *Text-book of Plant Physiology*, both of them excellent works which supersede GOODALE'S *Physiological Botany*—a work of similar scope but now obsolete through lack of revision. A more synoptical, but quite admirable exposition of the principles of the subject by F. NOLL, is in STRASBURGER'S *Text-book of Botany*, while from the practical point of view, of gardening and the like, a very admirable treatment of the subject is SORAUER'S *Popular Treatise on the Physiology of Plants*. There is also a very suggestive treatment of plant and animal physiology together, in VERWORN'S *Text-book of General Physiology*. A work which combines an excellent presentation of the elements of the subject, with practical laboratory directions for its study, is MACDOUGAL'S *Practical Text-book of Plant Physiology*, while a later

work by CLEMENTS has the same aim for the combined field indicated by its title, *Plant Physiology and Ecology*. These works mark a transition over to books devoted entirely to the laboratory treatment of the subject, of which, for advanced work, the most influential have been DETMER'S *Practical Plant Physiology*, and DARWIN and ACTON'S *Practical Physiology of Plants*, both of them works of a high order, which, however, I have had the assurance to try to supersede by a work of my own mentioned below. For more elementary use, there are, aside from ATKINSON'S very elementary *First Studies of Plant Life*, and MACDOUGAL'S brief *Nature and Work of Plants*, a good little work by the latter writer, *Elementary Plant Physiology*, while OSTERHOUT'S *Experiments with Plants* is a very admirable handbook for the simplest physiological experimentation. Finally, I have myself recently published the second edition of my *Laboratory Course in Plant Physiology*, which attempts to treat the practical teaching of Plant Physiology from the point of view of both the advanced and the elementary teacher, and aims to constitute a monographic handbook of information upon the educational phases of the subject. And I may add that another work of my own, intended to set forth our present knowledge of the phenomena of plant life, not in form of a text-book but rather as a work for the general reader, is expected to appear within a year in the Nature Series of Messrs. Henry Holt & Co.

A division of Physiology which has grown rapidly of late is Ecology (spelled also *Œcology*), and it is, indeed, itself differentiating into two subdivisions, which may be termed general ecology and ecological plant geography. Upon general ecology the greatest work is KERNER'S *Natural History of Plants*, a superbly-illustrated four-volume work, which is a perfect treasury of ecological information and suggestion. It must be used with some caution, however, since its author is over-sanguine at times in his discovery of adaptations where others have not been able to see them. But the student needs to learn this caution for all books, which he should read in the knowledge that a thing is not necessarily true because told, even in the most assertive of tones, in the very best of books. One of the most important topics of general ecology is the transport of pollen, or cross-pollination, of plants; and upon this there is an ecological classic, of which the introduction gives the best synoptical exposition of the subject we yet possess, namely, MÜLLER'S *Fertilization of Flowers*, which, however, in its detail, is being superseded by KNUTH'S cyclopedic work, now complete in three volumes, *Handbook of Floral Pollination*. In this connection every one will think of DARWIN'S researches, and three of his books, *The Various Contrivances by which Orchids are Fertilized by Insects*, *The Effects of Cross and Self Fertilization in the Vegetable Kingdom*, and *Different Forms of Flowers on Plants of the Same Species*,



are, and will remain, standard authorities in their particular fields. These works, indeed, are of the only type which in Science retains permanent value and cannot be superseded, — namely, those which are not compilations, but contain original data taken for the first time direct from Nature. Brief and popular expositions of cross-pollination are given by LUBBOCK, in his *Flowers, Fruits, and Leaves*, by A. GRAY, in a short book all too little known, *How Plants Behave*, and in his several text-books, while there is an admirable popular account of the subject, beautifully written and illustrated, by W. H. GIBSON, in his *Blossom Hosts and Insect Guests*. Another very attractive phase of general ecology concerns the transport or dissemination of plants, upon which, curiously enough, while there is an abundance of special literature, there is as yet no accessible comprehensive work, though some of the more interesting facts are well told by BEAL, in his *Seed Dispersal*, and more simply by WEED, in his *Seed Travelers*. Another phase of general ecology is represented by DARWIN'S *Insectivorous Plants*, and another by his *Movements and Habits of Climbing Plants* and his *Power of Movement in Plants*, all of which are books of the same foundational character as the others of DARWIN'S above mentioned.

Turning to the other phase of ecology, viz. plant geography, we possess two books of preëminent merit, SCHIMPER'S *Plant Geography on a Physiological Basis*, a thor-

oroughly-scientific, clearly-written, and splendidly-illustrated exposition of the characteristics of the different types of vegetation of the world, and WARMING'S *Ecology of Plants*, devoted to the study of plant communities, a work of the greatest authority, clearness, and comprehensiveness, invaluable to every person interested in the study of vegetation. These works could hardly be more satisfactory in their special fields, and would that we had more like them! WARMING'S work is not illustrated, but in this connection one recalls the splendid photographs of vegetation now being issued by KARSTEN and SCHENCK, and already mentioned under the chapter on Botanical Illustrations. It is this type of ecology which is treated in CLEMENTS'S work already mentioned, and it receives much attention from most of the recent American text-books.

The reader will have noticed ere this that I am citing, as a rule, only books in the English tongue. This is by no means because I am unmindful of the abundance of great books in other languages, but simply because I know that in practice, only a few either of our teachers or our students can really make use of works not in English. Moreover, practically every foreign book of real importance to the general student is now translated into English, a field of educational activity which Englishmen have made particularly their own. Thus, several of the more important of the works mentioned on the last few pages are translations from the German, and for the

most part are published in beautiful form by the Clarendon Press, of Oxford. For this great educational service, I venture to extend the thanks of my fellow-teachers, with my own, to our colleagues across the water.

We turn now to books which deal with the study of the groups of plants, and at the outset we must make some distinction between works devoted to the natural history of plants, that is, to their habits, structure, adaptations, ranges, uses, and the like, and works devoted purely to their natural relationships as expressed in classification. Upon the natural history of all the great groups there is no modern work in English, but there is an authoritative and splendidly-illustrated great work in German, namely, ENGLER and PRANTL'S *Die natürlichen Pflanzenfamilien*, now nearly completed in some twenty large volumes, whose bulk and cost will prevent their translation. This is devoted to the families of plants and their principal genera, but under ENGLER'S editorship a new work is appearing entitled *Das Pflanzenreich* [The Plant Kingdom], intended to treat in a thorough manner all the species of plants of the world. Some forty parts, a few in English, have so far appeared, but it will require many years and dozens of volumes to complete it. Of more synoptical works, one of the best is LE MAOUT and DECAISNE'S *General System of Botany*, now unfortunately becoming obsolete through age, but otherwise the very type of what such a work should be. A briefer work, now also in need of revision,

is WARMING'S *Handbook of Systematic Botany*. A very excellent synopsis of all the groups is contained in CAMPBELL'S *University Text-book of Botany*, while several of the recent advanced text-books, notably SCHENCK and KARSTEN'S part of STRASBURGER'S *Text-book of Botany*, and BERGEN and DAVIS'S *Principles of Botany*, contain admirable synopses of the natural history of the groups, — in all cases, however, with more emphasis on morphology than upon natural history. Of works treating the natural history of particular groups, there are several of great excellence. Upon the trees of North America, north of Mexico, there is a superb work, one of the very finest publications of any kind ever published in any country, in fourteen great volumes, *The Silva of North America*, by C. S. SARGENT, who has also published a synoptical *Manual of the Trees of North America*, which is our standard work for their identification and characteristics. So attractive, indeed, is this group of the American trees that we are almost embarrassed by a richness of good works upon them, for there is also a very authoritative and distinctive *Hand-book of the Trees of the Northern States and Canada East of the Rocky Mountains*, by R. B. HOUGH, and a yet more recent and very admirable work, *North American Trees*, by N. L. BRITTON, which is more especially a natural history than either of the two just mentioned. Upon the trees of New England in particular, there is a very satisfactory little *Handbook* by DAME and BROOKS. Belong-

ing here also is PENHALLOW'S *Manual of the North American Gymnosperms*, notable for the completeness of its treatment of the microscopical characters of the wood of these trees. And there are also many popular books, diverse in merit, of which I know little.

The reader will notice that when I speak of popular books, I am obliged, as a rule, to confess ignorance of them. This, however, is my misfortune. I know that many of these books are admirable in spirit and matter, and a source of pleasure to many people to whom more scientific works are unavailable. Fortunately we are free in Botany (thanks, probably, to the nature of the subject) from the works of those shallow pretenders to natural knowledge who write charming lies about animals and declare them truths; and the faults of popular botanical books are mostly those of the head rather than of the spirit. I do not know the popular botanical books, partly because I have not the time to become familiar with them, and partly because I do not think that any person who can make use of the authoritative scientific works can find permanent satisfaction in using the imperfect popular ones. In the acquisition of knowledge one can afford to have nothing less than the very best, and the scientific works, even though far harder and less interesting to use, yield a satisfaction and sense of security which repay many-fold the additional expense and trouble which they entail.

We turn now from the works on the natural history of

plants to those which deal purely with classification, — those technically known as taxonomic works. These give synoptical descriptions of characters having classificatory value, names, ranges, and interrelationships of plants, together with artificial keys which permit the identity of an unknown plant to be determined. Most of the natural history works give such data and keys, and all should do so; and no doubt the ideal *Manual* of the future will give the essential facts in the anatomy, morphology, physiology, ecology, and economics of each plant, on a system and in a language as definite as that which now expresses the taxonomic characters. For the wild flowering plants of the northeastern quarter of North America, we have two works remarkable for their completeness and accuracy, BRITTON'S *Manual of the Flora of the Northern States and Canada*, and ROBINSON and FERNALD'S seventh edition of GRAY'S *Manual*. These works cover the same ground, and describe the same plants on the same plan; and they differ from one another, aside from minor details, chiefly in the matter of the scientific names of these plants, a considerable number of which are different in the two books. The meaning of this difference in nomenclature I shall try to explain in the chapter which follows. Of the two, however, GRAY'S *Manual* has the merit of greater newness, of exact agreement with the system of scientific names adopted by an International Botanical Congress since BRITTON'S book was

published, of more abundant keys to aid in identification, and of many clear little pictures of plants whose identification is difficult. As concerns illustrations, however, there is another work, by BRITTON and BROWN, viz. the *Illustrated Flora*, which includes the same plants, on the same system of nomenclature, as BRITTON'S *Manual*, but illustrates every species by a simple outline cut. For the plants of the southeastern United States there is an exhaustive recent work, SMALL'S *Flora of the Southeastern United States*, which in a measure supersedes the older CHAPMAN'S *Flora of the Southern United States*. For the Rocky Mountain region there is a *Manual* by COULTER, of which a new edition, revised by NELSON, has recently appeared. These are all of the comprehensive manuals yet published for the flora of North America, but a dozen or more good local floras exist for particular sections, merging off without break into innumerable local lists, all rather too special for mention in this place. But each reader who may have interest in his local flora should make sure of the works relating thereto by writing to the Professor of Botany in the nearest large university. Finally, there are two elaborate but still incomplete floras, covering all of North America, north of Mexico, the older *Synoptical Flora* of GRAY (continued by WATSON and ROBINSON) and the newer *Flora of North America* in course of publication in parts by BRITTON and others.

Passing to the lower plants, we find that the distinction

between works on natural history and upon classification is less marked, and tends to disappear with the lowest groups. The Ferns and their allies (Pteridophytes) are treated as to their classification along with the flowering plants in the various Manuals already mentioned. But upon their natural history and classification together we have, for North America, two very satisfactory works: EATON'S elaborate and beautifully-illustrated monograph, *The Ferns of North America*, and WATERS'S more synoptical work, *Ferns, a Manual for the Northeastern States*, the latter a book which in authority and clearness of text, and completeness and accuracy of illustration, forms one of the most satisfactory books we possess upon the natural history of any group. Of a more technical character, indeed a work on their morphology rather than their natural history, is CAMPBELL'S *The Structure and Development of Mosses and Ferns*, while of a more popular and synoptical character are CLUTE'S *Our Native Ferns in their Haunts*, and *The Fern Allies of North America*, both excellent works, as is UNDERWOOD'S *Our Native Ferns and their Allies*. On the Mosses the foundation work is LESQUEREUX'S *Mosses of North America*, which, however, for the uses of the teaching botanist is superseded by GROUT'S excellent work, *Mosses with a Hand Lens and Microscope*, while CAMPBELL'S work above-mentioned treats their morphology especially. Upon Liverworts we have nothing available except the purely



classificatory treatment by UNDERWOOD in the sixth edition of GRAY'S *Manual*, and a treatment of the more prominent forms in the second edition of GROUT'S *Mosses with a Hand Lens*, and there is much need for a work, of the combined natural history and classification type, upon this group. Upon Lichens we have two works by SCHNEIDER, his *Guide to the Study of Lichens* and his *Text-book of General Lichenology*, which give keys for the identification of the North American forms. Upon the Fungi in general the well-known work by DE BARY, *Comparative Morphology and Biology of Fungi*, is now obsolete without a successor, though MASSEE'S *Text-book of Fungi* is a good synopsis. For the identification of the principal genera of North American forms we have a little handbook by UNDERWOOD, *Molds, Mildews, and Mushrooms*, while for the determination of the genera of Fungi in general we have a new work, *The Genera of Fungi*, by CLEMENTS. Upon the particular groups of Fungi which rise into economic importance, however, we have some good books. Thus, upon the Mushrooms, we have a very authoritative and well-illustrated work in ATKINSON'S *Mushrooms*, the best single book on the subject; but there are also some elaborate books, running especially to colored illustrations, such as MACILVAINE and MACADAM'S *One Thousand American Fungi*, and some others of popular sort, as to the merits of which the experts are not convinced. There is a very

excellent and attractive popular account of some thirty of the more prominent kinds in GIBSON'S *Our Edible Toadstools and Mushrooms and how to Distinguish Them*. Upon those Fungi which are the causes of plant diseases there is a very satisfactory book in TUBEUF'S *Diseases of Plants induced by Cryptogamic Parasites*, a general work which, however, covers the principal kinds of America, while a new work, applicable especially to America, has just appeared in DUGGAR'S *Fungous Diseases of Plants*. Upon the Slime Molds we have an excellent work; combining natural history and classification, in MACBRIDE'S *The North American Slime Molds*. Upon the Bacteria there is a standard general work in FISCHER'S *The Structure and Functions of Bacteria*, while those phases of the subject which interest the teaching botanist are well treated in JORDAN'S recent *Text-book of General Bacteriology*, and the economics of the commoner kinds are very clearly discussed in CONN'S *Bacteria, Yeasts, and Molds in the Home*. Upon Algæ, our literature is inadequate. A very useful general work on the subject is MURRAY'S *Introduction to the Study of Seaweeds*. For the natural history and classification of the freshwater forms we have a very satisfactory new work in COLLINS'S *Green Algæ of the United States*, but for the marine Algæ we have as yet nothing in the way of a general handbook, FARLOW'S well-known *Marine Algæ of New England* being now unobtainable.

From this summary it will be evident that while we have some admirable works upon the natural history and classification of American plants, these works as a whole are uneven in value and plan, and exhibit great gaps. There is need for a thorough treatment of all the groups upon a general natural history basis, giving for each its structural characters and classification (with suitable keys), habitat and distribution, and a summary of the principal facts about its morphology, physiology, ecology, economic uses, local nomenclature, and historical or folk-lore associations. Probably in time a complete series of such works, prepared by botanists who can command both expert knowledge and literary skill, will appear. It is obvious that the field for useful botanical endeavor still lies wide open to the capable student.

All of the works thus far mentioned are concerned only with wild plants. For the identification of those of garden and greenhouse we have as yet no handbook aside from the antiquated and imperfect *Field, Forest, and Garden Botany* of ASA GRAY, and in all the range of educational botanical literature there is at present no greater need than that for a good manual of cultivated plants. There is, however, an invaluable source of detailed information about cultivated plants in a work which is one of the most thorough and satisfactory in all botanical literature, the *Cyclopedia of American Horticulture*, edited by L. H.

BAILEY in four large volumes, the later issues of which contain keys for the identification of the families as well as of the genera and species.

At this point we may conveniently take note of several books which belong under none of our formal divisions, but which nevertheless have importance for the teaching botanist. Thus, in botanical economics, we have as yet no good modern work to replace J. SMITH'S somewhat antiquated and insufficient *Dictionary*, though a useful little handbook of the most important matters is WILLIS'S *Manual and Dictionary of Flowering Plants*. On Agriculture a host of works exists, of which the best from our present point of view is WARREN'S recent *Elements of Agriculture*, while a great work upon the same subject is L. H. BAILEY'S *Cyclopedia of Agriculture*, in four volumes. Upon those plants which are of greatest use to man there is an admirable botanical-economic study in SARGENT'S *Corn Plants*. Upon Soils there is a very authoritative recent work in HILGARD'S *Soils, their Formation, etc.* On Forestry we have two satisfactory works, PINCHOT'S *Primer of Forestry* and FERNOW'S *Economics of Forestry*, though, of course, there are many other good books on this important subject. An important element in modern progressive agriculture is Plant Breeding, and an admirable study of its principles is contained in L. H. BAILEY'S *Plant Breeding*, while the more recent practice is described by

DE VRIES in his book under the same title. On the important and well-known work of LUTHER BURBANK in plant breeding, there is an account, excellent except for a certain flamboyancy of treatment, in HARWOOD'S *New Creations in Plant Life*. On the medical aspects of plant economics an excellent synoptical work is KRAEMER'S *Text-book of Botany and Pharmacognosy*. Upon plant diseases in general there is an admirable little work by WARD, *Disease in Plants*. Concerning plant economics in general, it may be said that the most important of all accessible publications are those issued by the Department of Agriculture at Washington; and so many fields do these touch, and so admirable are they, for the most part, in matter and method, that whenever the teacher seeks information upon any economic subject, he should ascertain whether it is not covered by some publication of that department. And there is about them this further advantage, that they can usually be obtained without charge for educational purposes. On Fossil Plants the principal works are SOLMS-LAUBACH'S *Introduction to Fossil Botany*, though modern activity in this work makes it badly in need of revision, and SCOTT'S *Studies in Fossil Botany*. On the definition and derivation of botanical terms, the only book is JACKSON'S *Glossary of Botanic Terms*, a work, however, almost exclusively taxonomic. A new work on the history of Botany is GREEN'S *History of Botany 1860-1900*, a continuation of SACHS'S *History* mentioned

a few pages earlier.<sup>1</sup> Upon the teaching of Botany there is another book, LLOYD'S part of LLOYD and BIGELOW'S *Teaching of Biology in the Secondary School*, a very excellent work closely agreeing with this book in method and spirit, though, of course, differing in details.

We come finally to text-books, a class very important to the teaching botanist but very difficult to discuss, — for the obvious reasons which make it impossible for contemporaries to estimate correctly the values of history. In this country, to a greater degree than in others, the teaching of Botany has experienced a complete transformation within the quarter century just closed; for it has passed from a system based almost exclusively on formal morphology and classification, studied chiefly from text-books with laboratory illustration, to a system of laboratory study of the more important and illuminating matters drawn from

<sup>1</sup> Books on Nature Study hardly fall within the scope of this book, but should be treated in a corresponding work devoted to that distinct and important department of educational activity. Yet the teacher may have occasion to refer to them, and I will simply mention those which seem to me the most prominent. They are E. G. HOWES, *Advanced Elementary Science* (New York, D. Appleton & Co.): C. F. HODGE, *Nature and Life* (Boston, Ginn & Co.), F. L. HOLTZ, *Nature Study* (New York, Scribner's): J. M. and J. G. COULTER and ALICE J. PATTERSON, *Practical Nature Study and Elementary Agriculture* (New York, D. Appleton & Co.). A notable discussion of the true educational status of Nature Study is L. H. BAILEY'S *The Nature Study Idea* (New York, Doubleday, Page Co.), while the subject is fortunate in having devoted to it an admirably-conducted journal, *The Nature Study Review*, the volumes of which constitute one of the best of treatises on its subject.

any divisions of the science, correlated and extended by use of the text-book. The progress of the transition has been marked by many good books, rendered obsolete in succession by new advances. The works of ASA GRAY mark the culmination of the older method. His three famous books: *How Plants Grow*, for the lower schools, *Lessons in Botany*, rewritten as his *Elements of Botany*, for high schools, and his *Structural Botany*, for colleges, were not only unmatched in their day, but within their limits they probably cannot be improved upon by anybody. It is not better books which have superseded them, but books which better represent the state of the advancing science and the results of developing educational opinion. They represented a stage in which study of the text-book formed a larger part of botanical instruction than did study in the laboratory, and the first weakening of their influence accompanied the rapid rise of laboratory study, which expressed itself in the production of laboratory manuals, — that is guides to laboratory work, which were not text-books at all. The change came earlier abroad than with us, and is most conspicuously marked by HUXLEY and MARTIN'S *Practical Biology*, which was a guide to the thorough laboratory study of leading plant forms, and a work which has had a very great influence upon biological education. This plan, that of the intensive study of a few "types," was adopted in ARTHUR, BARNES, and COULTER'S *Handbook of Plant Dissection*, in SEDGWICK and WILSON'S *General*

*Biology*, in DODGE'S *Introduction to Elementary Practical Biology*, and in Miss RANDOLPH'S *Laboratory Directions in General Biology*. The same method and idea, of a guide to practical laboratory study, but applied variously to the more general study of a larger number of types and even to the study of structural and ecological matters, underlies the preparation of SPALDING'S *Guide to the Study of Common Plants*, SETCHELL'S *Laboratory Practice for Beginners in Botany* (a work prepared upon the unusual plan of telling the student in detail what he is to see), in CLARK'S *Laboratory Manual of Practical Botany*, in MACBRIDE'S *Lessons in Botany*, in PEPOON, MITCHELL, and MAXWELL'S *Studies of Plant Life*, in CLEMENTS and CUTTER'S *Laboratory Manual of High School Botany*, in CALDWELL'S *Laboratory Manual of Botany*, and his *Handbook of Plant Morphology* (the latter a modernized edition of ARTHUR, BARNES, and COULTER'S *Handbook of Plant Dissection*), and in CLUTE'S recent *Laboratory Botany for the High School*. The same spirit of reaction from text-books towards guides to practical work showed itself for field studies in Miss NEWELL'S excellent *Outlines of Lessons in Botany*, with their accompanying *Readers*, and also in BAILEY'S more advanced *Lessons with Plants*. At the same time the reaction from the purely structural and classificatory material of the older instruction began to show in the production of text-books of the synthetic type, which also appeared abroad before they did with us.



The first of these in this country, and a book which has had a wide influence in directing later work, was BESSEY'S *Botany for High Schools and Colleges*.

The rise of the laboratory manuals threw the text-books for a time into the background, and many teachers attempted to dispense with them altogether, thinking it best that the student should learn wholly from nature with only such other aid as the teacher himself, or certain reference works, could supply. Experience, however, soon showed that laboratory study, while absolutely essential for the training of natural powers and the correct understanding of natural facts and phenomena, by itself gives an imperfect knowledge of the subject. Dealing as it necessarily does, even at its best, with a few selected types, the view it gives is more or less disconnected, disproportioned, and incomplete, the more especially since many topics of the greatest importance cannot, for practical reasons, be introduced into the laboratory at all. Of course, instruction by lectures, demonstration, and reference-reading partly overcomes these drawbacks, but a substantial agreement gradually developed to the effect that not only is the text-book necessary for correlating and welding together the laboratory topics, but it is positively desirable as a source of accurate botanical information which the students can be required to study with care, and for a knowledge of which they can be held responsible. One objection to its use, that students rely upon it for information rather than

on their own laboratory observation, is readily met by a requirement that the reading must follow and not precede the laboratory study. Hence a new type of book arose, combining laboratory manual, or at least practical directions for laboratory work, and text-book. At the same time it was becoming more evident than ever that the conditions of botanical education in this country require the existence of three grades of general text-books, — a simpler grade for high schools which possess indifferent facilities, or which can give but a half year to the science, an intermediate grade for high schools which have good facilities and which give a year to the subject, and an advanced grade for normal school and college classes. Of the simpler grade, one of the first of the new type to appear was BESSEY'S *Essentials of Botany*, and it was followed by BERGEN'S *Elements of Botany*, while later came BAILEY'S *Botany, an Elementary Text for Schools*, BARNES'S *Outlines of Plant Life*, ATKINSON'S *Lessons in Botany*, LEAVITT'S *Outlines of Botany* (which is a revision of GRAY'S *Lessons in Botany*), COULTER'S *Plant Studies*, ANDREWS'S *Botany All the Year Round*, while most recent of all is a *Beginners' Botany* by L. H. BAILEY. Here also belongs SPOTTON'S *Elements of Structural Botany*, a work very extensively used in Canada. Belonging in this class also are those works including a botanical half of a year's course in Biology, the most recent of which are HUNTER'S *Elements of Biology* (intended especially for the specifica-

tions of the New York high schools), and BAILEY and COLEMAN'S *First Course in Biology*, while announcement has been made of a new work soon to appear, *Applied Biology*, with a Teacher's Handbook, by M. I. BIGELOW.

Some of the books in the list above, as likewise some in the list two pages later, show a transition from the older to the newer instruction in the provision of an abbreviated flora, added as an appendix, for the identification of local plants. Another persistence of the older type is found in the several "Notebooks" issued by different firms, with suitable outlines for floral analysis. Other prepared notebooks are also issued with printed directions and blank space for the records of various exercises, the most prominent of which is BERGEN'S, prepared to accompany his text-books.<sup>1</sup>

In reading these notes upon text-books, and likewise those which will follow, the reader may feel bewildered in the midst of their number, and disappointed that I do not more definitely characterize their relative merits. But in truth this would be an impossible task. In the first place they are all good books, any one of which would have stood out a generation ago as a work of conspicuous merit.

<sup>1</sup> Published by Ginn & Co., Boston, who also publish W. H. D. MEIERS'S *Plant Study and Description*. A *National Biology Notebook*, notebook and text-book in one, by A. S. DEWING, is published by the Knott Apparatus Co., of Boston. The best-known notebook for use in plant analysis of the older type is APGAR'S *New Plant Analysis*, published by the American Book Co. New York.

The conditions of publication of text-books nowadays, — the closeness of competition between publishers in face of the excellence of books already in the field, the care that most authors now take to have their chapters revised by experts in the various subjects, and the custom of publishers to ask competent advice upon manuscripts before their acceptance for publication, all combine to make it well-nigh impossible for a poor book to come into the market at all, even though these precautions do not suffice to preclude some minor flaws in the best. There is no criticism of our modern text-books on the ground of inaccuracy or incompleteness; it falls wholly upon the proportioning of topics and practicability in class use, both of which are matters of individual conviction and local needs. While, therefore, I have opinions upon most of these works, I know they would be shared as a whole by nobody else, and hence I suppress them and leave to the reader a field that is clear for his own. I think it is safe to say that no text-book ever fits exactly any teacher's needs except the one he writes for himself, and that not for long, though I hasten to add that this statement is not designed to encourage all teachers to write books for themselves.<sup>1</sup>

<sup>1</sup> It will be observed that in this summary account of text-books, I say nothing about the foreign ones except in the few cases where there are American editions. This is not, of course, because ours are better, but because they are better adapted to our methods of instruction, as, of course, the foreign ones are to foreign methods. It is, however, but fair to call attention to the fact that our own instruction has been profoundly

We pass now to the works of intermediate grade, those designed for a year's work in high schools having good facilities. In these we note the beginning of a tendency which is almost invariably carried out in the more advanced books, of separating the laboratory directions and text-book. The most prominent works, for this grade, which combine the two are ATKINSON'S *Elementary Botany*, BERGEN'S *Foundations of Botany* (with its accompanying *Handbook* for teachers), together with his nearly identical though somewhat enlarged and more recent *Essentials of Botany*, and STEVENS'S *Introduction to Botany*, all of them works of the first class. Other works which show a tendency to the separation of laboratory directions and text-book, are CAMPBELL'S *Elements of Structural and Systematic Botany*, BARNES'S *Plant Life*, which relegates the laboratory directions to an Appendix, and COULTER'S *Plants, a Text-book of Botany*, which is made up of his *Plant*

affected in the past by certain foreign books, notably by the English translations of SACHS'S great *Text-book*, a work which more than any other served to introduce the synthetic conception into our instruction. The translation of THOMÉ'S *Structural and Physiological Botany* was also a good deal used in this country. The great influence exerted by HUXLEY and MARTIN'S *Practical Biology* is well known, but BOWER and VINES'S *Course of Practical Instruction in Botany* also had considerable influence. Of the English text-books now in use the most important known to me are VINES'S *Text-book of Botany*, FARMER'S *Practical Introduction to the Study of Botany*, GROOM'S *Elementary Botany*, and LOWSON'S *Text-book of Botany*. Another recent foreign book of distinctive interest is BERTHA STONEMAN'S *Plants and their Ways in South Africa*.

*Relations and Plant Structures* bound together, to each of which there is a small separate *Suggestions to Teachers*, devoted chiefly to laboratory matters. A new work for high schools, announced as soon to appear, by ATKINSON, is also expected to belong to this grade.

Finally, we come to text-books of advanced grade, suitable only for the exceptionally equipped high school and designed rather for normal school and college. In these, with the single exception of ATKINSON'S *College Text-book of Botany*, the laboratory directions are either transferred to a separate small volume, or are omitted altogether, so that the text-book is a reading-and-study book pure and simple. Exactly of this type is BERGEN and DAVIS'S *Principles of Botany*, with its accompanying *Laboratory and Field Manual of Botany*, which represent the most recent and highest development of this type of book. The tendency thus to separate laboratory directions from text-book is increasing, and will no doubt in time prevail in all books intended for this grade, since it permits far greater flexibility of instruction, and much better adaptation to local conditions and individual methods. It is, of course, the logical application of this principle which has produced this book, or at least the second part of it. Of text-books proper we have BESSEY'S *Botany for High Schools and Colleges*, CURTIS'S *Text-book of General Botany*, and his more recent *Nature and Development of Plants*. CAMPBELL'S *University Text-book of Botany* belongs rather with advanced

classes in morphology, since it is almost wholly devoted to the groups, while KRAEMER'S *Text-book of Botany and Pharmacognosy* is designed rather for students of Pharmacy. Typical books of this type are VINES'S *Elementary Text-book of Botany* and the *Text-book of Botany* by STRASBURGER, NOLL, SCHENCK and KARSTEN, a work quite unmatched for its combination of high authority, wealth of condensed material, and profusion of good illustration. A new work, apparently of similar type and scope, is announced as soon to appear, by COULTER and others of the University of Chicago. Some of these works, in consequence no doubt of the coöperation of several in their authorship, show a sharp separation of the morphology from the physiology, though the modern tendency in all of our instruction is towards a synthetic treatment in which these phases are welded together at the places of their most natural connection.

Such are the existent books of concern to the botanical teacher, as I understand them. So great is the abundance of good material on the educational phases of our subject that it sometimes appears as if we were nearing a condition in which it is no longer a problem to find good books, but attentive readers. Nevertheless, as I have earlier shown, there are still many gaps to be filled. If the reader finds need of any further information upon this subject, I advise him to write to the nearest univer-

sity professor of Botany, whose duty it is to know these things, and whose pleasure it ought to be to give advice about them.

## BIBLIOGRAPHY

A bibliographical synopsis of the works mentioned (exclusive of those in footnotes) in this work. The prices, for bound copies, are taken from publishers' lists, and are sometimes subject to discount, while the prices for books printed in England are some forty per cent (twenty-five per cent if unbound) less if imported duty-free for educational institutions. Care should be taken to ask always for the latest editions, for which, of course, the prices are given in this list.

- American Botanist*. Published by W. N. Clute, Joliet, Ill. 6 numbers a year. 75 cents.
- ANDREWS, E. F. *Botany All the Year Round*. New York. American Book Co. 1903. \$1.00; with *Flora*, \$1.50.
- ARTHUR, J. C., BARNES, C. R., and COULTER, J. M. *Handbook of Plant Dissection*. New York. Henry Holt & Co. 1887. \$1.20. See also CALDWELL, O. W., *Handbook of Plant Morphology*.
- ARTHUR, J. C., and MACDOUGAL, D. T. *Living Plants and their Properties*. New York. Baker & Taylor. 1898. \$1.25.
- ATKINSON, G. F.
- (1) *Elementary Botany*. New York. Henry Holt & Co. 1898. \$1.25.
  - (2) *Lessons in Botany*. New York. Henry Holt & Co. 1900. \$1.12.
  - (3) *Mushrooms, Edible, Poisonous, etc.* New York. Henry Holt & Co. 1903. \$3.00.
  - (4) *First Studies of Plant Life*. Boston. Ginn & Co. 1901. \$1.00.
  - (5) *A College Text-book of Botany*. New York. Henry Holt & Co. 1905. \$2.00.
- BAILEY, L. H.
- (1) *The Survival of the Unlike*. New York. The Macmillan Co. 1896 and later. \$2.00.



- (2) *Lessons with Plants*. New York. The Macmillan Co. 1898. \$1.10.
- (3) *Plant Breeding*. New York. The Macmillan Co. 1895 and later. \$1.25.
- (4) *Botany, an Elementary Text for Schools*. New York. The Macmillan Co. 1900 and later. \$1.10.
- (5) *Beginners' Botany*. New York. The Macmillan Co. 1909. 60 cents.

BAILEY, L. H. (Editor).

(1) *Cyclopedia of American Horticulture*. New York. The Macmillan Co. 4 vols. 1900-1902, and later issues. \$20.00.

(2) *Cyclopedia of American Agriculture*. New York. The Macmillan Co. 4 vols. 1907-1909. \$20.00.

BAILEY, L. H., and COLEMAN, W. M. *First Course in Biology*. New York. The Macmillan Co. 1908. \$1.25.

BAILEY, W. W. *Botanizing*. Providence. Preston & Rounds Co. 1907. \$1.00.

BARNES, C. R.

(1) *Plant Life, considered with Special Reference to Form and Function*. New York. Henry Holt & Co. 1898. \$1.12.

(2) *Outlines of Plant Life, with Special Reference to Form and Function*. New York. Henry Holt & Co. 1900. \$1.00.

BEAL, W. J. *Seed Dispersal*. Boston. Ginn & Co. 1898 and later. 60 cents.

BERGEN, J. Y.

(1) *Elements of Botany*. Boston. Ginn & Co. 1896 and later. \$1.00. (Also with a brief Flora, \$1.30.)

(2) *Foundations of Botany*. Boston. Ginn & Co. 1901 and later. \$1.30. (Also with a brief Flora, \$1.50. A Handbook for teachers is supplied, 30 c.)

(3) *Essentials of Botany*. Boston. Ginn & Co. 1909. \$1.20. (Also with a brief Flora, \$1.50.)

BERGEN, J. Y., and DAVIS, B. M.

(1) *Principles of Botany*. Boston. Ginn & Co. 1906. \$1.50.

(2) *Laboratory and Field Manual of Botany* [to accompany the preceding]. Boston. Ginn & Co. 1907. 90 cents.

BESSEY, C. E.

- (1) *Botany for High Schools and Colleges*. New York. Henry Holt & Co. 1880 and later editions. \$2.20.
- (2) *The Essentials of Botany*. New York. Henry Holt & Co. 1884 and later. \$1.12.

*Botanical Gazette*. Monthly. Chicago. The University of Chicago. \$7.00 per year.

BRITTON, N. L.

- (1) *Manual of the Flora of the Northern States and Canada*. New York. Henry Holt & Co. 1901. \$2.25.
- (2) *North American Trees, being Descriptions and Illustrations of the Trees growing independently of Cultivation in North America, North of Mexico, and the West Indies*. New York. Henry Holt & Co. 1908. \$7.00.

BRITTON, N. L. (Editor). *Flora of North America*. Appearing in parts. New York Botanical Garden.

BRITTON, N. L., and BROWN, A. *An Illustrated Flora of the Northern United States, Canada, etc.* New York. Charles Scribner's Sons. 3 vols. 1896-1898. \$4.00 a volume.

*Bulletin of the Torrey Botanical Club*. Monthly. Lancaster, Pa. \$3.00 a year.

CALDWELL, O. W.

- (1) *Laboratory Manual of Botany*. New York. D. Appleton & Co. 1902. 60 cents.
- (2) *Handbook of Plant Morphology, being the Handbook of Plant Dissection* by J. C. ARTHUR, CHARLES R. BARNES, and JOHN M. COULTER revised and rewritten. New York. Henry Holt & Co. 1904. \$1.00.

CAMPBELL, D. H.

- (1) *Elements of Structural and Systematic Botany*. Boston. Ginn & Co. 1891. \$1.12. (Out of print.)
- (2) *The Structure and Development of the Mosses and Ferns*. New York. The Macmillan Co. 1895 and later. \$4.50.
- (3) *Lectures on the Evolution of Plants*. New York. The Macmillan Co. 1899. \$1.25.
- (4) *A University Text-book of Botany*. New York. The Macmillan Co. 1902. \$4.00.

CHAMBERLAIN, C. J. *Methods in Plant Histology*. Chicago. University of Chicago Press. 1901 and later. \$2.25.

CHAPMAN, A. W. *Flora of the Southern United States, etc.* American Book Co. 1860 and later. \$4.00.

CLARK, C. H. *A Laboratory Manual of Practical Botany*. New York. American Book Co. 1898. 96 cents.

CLEMENTS, F. E.

(1) *Plant Physiology and Ecology*. New York. Henry Holt & Co. 1907. \$2.00.

(2) *The Genera of Fungi*. Minneapolis. N. W. Wilson Co. 1909. \$2.10.

CLEMENTS, F. E., and CUTTER, I. S. *A Laboratory Manual of High School Botany*. Lincoln, Neb. University Publishing Co. 1900. 75 cents.

CLUTE, W. N.

(1) *Our Ferns in their Haunts, a Guide to All the Native Species*. New York. F. A. Stokes Co. 1901. \$2.00.

(2) *The Fern Allies of North America, North of Mexico*. New York. F. A. Stokes Co. 1905. \$2.00.

(3) *Laboratory Botany for the High School*. Boston. Ginn & Co. 1909. 75 cents.

COLLINS, F. S. *Green Algae of the United States*. Tufts College Studies. 1909. \$3.50.

CONN, H. W. *Bacteria, Yeasts, and Molds in the Home*. Boston. Ginn & Co. 1903. \$1.20.

COULTER, J. M.

(1) *Manual of the Botany of the Rocky Mountain Region*. New York. American Book Co. 1885. \$1.62. See NELSON, A.

(2) *Plants, a Text-book of Botany* [combining two books, *Plant Relations* and *Plant Structures*]. New York. D. Appleton & Co. 1900. (Suggestions for Teachers, two pamphlets, one by O. W. CALDWELL, are supplied with this work to teachers.) \$1.80.

(3) *Plant Studies, an Elementary Botany*. New York. D. Appleton & Co. 1900 and later. \$1.25. (Also a brief Flora.)

COULTER, J. M., and CHAMBERLAIN, C. J.

(1) *Morphology of Angiosperms*. New York. D. Appleton & Co. 1903. \$2.50.

- (2) *Morphology of Spermatophytes: Part I, Gymnosperms.* New York. D. Appleton & Co. 1901. \$1.75.

CURTIS, C. C.

- (1) *Text-book of General Botany.* New York. Longmans, Green, & Co. 1897. \$3.00.  
 (2) *Nature and Development of Plants.* New York. Henry Holt & Co. 1907. \$2.50.

DAME, L. L., and BROOKS, H. *Handbook of the Trees of New England.* Boston. Ginn & Co. 1902. \$1.50.

DARWIN, CHARLES.

- (1) *The Origin of Species.* 1885. Sixth edition. \$2.00.  
 (2) *Journal of Researches into the Natural History and Geology of the Countries visited during the Voyage of H. M. S. Beagle round the World.* \$2.00. (Edition by Scribner's, \$1.00.)  
 (3) *The Power of Movement in Plants.* \$2.00.  
 (4) *Insectivorous Plants.* \$2.00.  
 (5) *Movements and Habits of Climbing Plants.* \$1.25.  
 (6) *The Various Contrivances by which Orchids are Fertilized by Insects.* \$1.75.  
 (7) *The Effects of Cross and Self Fertilization in the Vegetable Kingdom.* \$2.00.  
 (8) *Different Forms of Flowers on Plants of the same Species.* \$1.50.  
 All published by D. Appleton & Co. New York.

DARWIN, F.

- (1) *The Life and Letters of Charles Darwin.* New York. D. Appleton & Co. 1888. 2 vols. \$4.50.  
 (2) *More Letters of Charles Darwin.* New York. D. Appleton & Co. 1903. 2 vols. \$5.00.

DARWIN, F., and ACTON, E. H. *Practical Physiology of Plants.* Cambridge. 1894 and later. G. P. Putnam's Sons. \$1.25.

DE BARY, A.

- (1) Translated by BOWER and SCOTT. *Comparative Anatomy of the Vegetative Organs of Phanerogams and Ferns.* Oxford. Clarendon Press. 1884. \$6.75.  
 (2) Translated by H. E. F. GARNSEY. *Comparative Morphology and Biology of Fungi, Mycetozoa, and Bacteria.* Oxford. Clarendon Press. 1887. \$6.75.

- DETMER, W. Translated by S. A. MOOR. *Practical Plant Physiology*. New York. The Macmillan Co. 1898. \$3.00.
- DE VRIES, H. *Plant Breeding. Comments on the Experiments of Nilsson and Burbank*. Chicago. Open Court Publishing Co. 1907. \$1.50.
- DODGE, C. W. *Introduction to Elementary Practical Biology*. New York. Harpers. 1894. \$1.80.
- DUGGAR, B. M. *Fungous Diseases of Plants*. Boston. Ginn & Co. 1910. \$2.00.
- EATON, D. C. *The Ferns of North America*. Boston. Bradlee Whidden. 1893. 2 vols. \$20.00 per volume.
- ELIOT, C. W. *Educational Reform*. New York. The Century Co. 1898. \$2.00.
- ENGLER, A. (Editor). *Das Pflanzenreich*. Leipzig. W. Engelmann. 1900. Appearing in parts, of which about 40, of varying size and price, are published.
- ENGLER and PRANTL. *Die natürlichen Pflanzenfamilien*. Leipzig. W. Engelmann. 1889. Appearing in parts, now nearly complete in about 20 volumes.
- FARLOW, W. G. *The Marine Algæ of New England*. Published by the United States Fish Commission, Washington. 1881.
- FERNOW, B. E. *Economics of Forestry*. New York. T. Y. Crowell & Co. 1902. \$1.50.
- FISCHER, A. Translated by A. C. JONES. *The Structure and Functions of Bacteria*. Oxford. Clarendon Press. 1900. \$2.50.
- GANONG, W. F. *A Laboratory Course in Plant Physiology*. Second edition, extended to form a *Handbook of Experimentation for Educational Use*. New York. Henry Holt & Co. 1908. \$1.75.
- GEDDES, P. *Chapters in Modern Botany*. New York. Charles Scribner's Sons. 1893. \$1.25.
- GIBSON, W. H.
- (1) *Blossom Hosts and Insect Guests*. New York. Newson & Co. 1901 and later editions. 80 cents.
  - (2) *Our Edible Toadstools and Mushrooms, and how to Distinguish Them*. New York. Harpers. 1902. \$3.50.
- GOEBEL, K.
- (1) Translated by GARNSEY and BALFOUR. *Outlines of Classi-*

*fication and Special Morphology of Plants.* Oxford. Clarendon Press. 1887. \$9.25.

- (2) Translated by I. B. BALFOUR. *Organography of Plants, especially of the Archegoniata and Spermatophyta.* Oxford. Clarendon Press. 1900-1905. 2 vols. \$10.00.

GOODALE, G. L. *Physiological Botany.* Vol. II of *Gray's Botanical Text-book.* New York. American Book Co. 1885. \$2.00.

GRAY, ASA.

- (1) *How Plants Grow. A Simple Introduction to Structural Botany.* New York. American Book Co. 1858 and later.
- (2) *Field, Forest, and Garden Botany.* Revised by L. H. BAILEY. New York. American Book Co. 1868 and later. \$1.44.
- (3) *How Plants Behave.* New York. American Book Co. 1875. 54 cents.
- (4) *Structural Botany.* Part I of GRAY'S *Botanical Text-book.* New York. American Book Co. 1880. \$2.00.
- (5) *Elements of Botany.* New York. American Book Co. 1887 and later editions. 94 cents.
- (6) *Synoptical Flora of North America* (incomplete). New York. American Book Co. 1878 and later. (Each part \$2.60.)
- (7) *Scientific Writings.* Edited by C. S. Sargent. Boston. Houghton, Mifflin & Co. 2 vols. 1889. \$6.00.
- (8) *Manual of the Botany of the Northern United States.* Sixth edition. New York. American Book Co. 1890. \$1.62. Field edition, \$2.00. For seventh edition, see ROBINSON, B. L.

GREEN, J. R. (1) *An Introduction to Vegetable Physiology.* Philadelphia. P. Blakiston's Son & Co. 1900 and later. \$3.00.

- (2) *A History of Botany 1860-1900, being a continuation of Sachs's 'History of Botany,' 1530-1860.* Oxford, Clarendon Press, 1909.

GROUT, A. J.

- (1) *Mosses with a Hand Lens.* Second edition enlarged to include the *Hepatics.* Published by the author, 360 Lenox Road, Brooklyn, N.Y. 1905. \$1.75.
- (2) *Mosses with Hand Lens and Microscope.* Published as above. 1903. 4 parts with one to come. \$5.00 unbound.

- HARWOOD, W. S. *New Creations in Plant Life*. New York. The Macmillan Co. 1905 and later. \$1.75.
- HILGARD, E. W. *Soils, their Formation, Properties, Composition, and Relations to Climate and Plant Growth in the Humid and Arid Regions*. New York. The Macmillan Co. 1906. \$4.00.
- HOUGH, R. B. *Handbook of the Trees of the Northern States and Canada, East of the Rocky Mountains*. Photo-descriptive. Lowville, N.Y. Published by the Author. 1907. \$8.00.
- HUNTER, G. W. *Elements of Biology. A Practical Text-book correlating Botany, Zoölogy, and Human Physiology*. New York. American Book Co. 1907. \$1.25.
- HUXLEY, L. *The Life and Letters of Thomas Henry Huxley*. New York. D. Appleton & Co. 1901. 2 vols. \$5.00.
- HUXLEY, T. H. *Science and Education*. Vol. III of his *Collected Works*. New York. D. Appleton & Co. 1894. \$1.25.
- HUXLEY, T. H., and MARTIN, H. N. *A Course of Elementary Instruction in Practical Biology*. London. The Macmillan Co. 1875 and later. \$2.60.
- JACKSON, B. D. *A Glossary of Botanic Terms with their Derivation and Accent*. Philadelphia. J. B. Lippincott & Co. 1900. \$2.00.
- JORDAN, E. O. *A Text-book of General Bacteriology*. Philadelphia. W. B. Saunders Co. 1908. \$3.00.
- JOST, L. Translated by R. J. H. GIBSON. *Lectures on Plant Physiology*. Oxford. Clarendon Press. 1907. \$6.75.
- Journal of Applied Microscopy*. Vols. I-VI. 1898-1903. Rochester, N.Y. Bausch & Lomb Optical Co.
- KARSTEN, G., and SCHENCK, H. *Vegetationsbilder*. Jena. G. Fischer. 1905. 2.50 marks each part.
- KERNER VON MARILAUN, A. Translated by F. W. OLIVER. *The Natural History of Plants*. New York. Henry Holt & Co. 4 vols. 1894-1895. \$11.00.
- KNUTH, K. Translated by J. R. A. DAVIS. *Handbook of Floral Pollination*. Oxford. Clarendon Press. 3 vols. 1906-1909. \$24.25.
- KRAEMER, HENRY. *A Text-book of Botany and Pharmacognosy Intended for the Use of Students of Pharmacy, as a Reference Book for Pharmacists, and as a Handbook for Food and Drug Analysis*. Philadelphia. J. B. Lippincott Co. Third edition. 1908. \$5.00.

- LEAVITT, R. G. *Outlines of Botany for the High School Laboratory and Classroom* (based on GRAY'S *Lessons in Botany*). New York. American Book Co. 1901. \$1.00.
- LE MAOUT, E., and DECAISNE, J. Translated by MRS. HOOKER. *A General System of Botany*. London. Longmans, Green, & Co. 1876. (Out of print.)
- LESQUEREUX, L., and JAMES, T. P. *Manual of the Mosses of North America*. Boston. S. S. Cassino & Co. 1884. \$4.00.
- LLOYD, F. E., and BIGELOW, M. A. *The Teaching of Biology in the Secondary School*. New York. Longmans, Green, & Co. 1904. \$1.50.
- LOCY, W. A. *Biology and its Makers*. New York. Henry Holt & Co. 1908. \$2.75.
- LUBBOCK, SIR J. *Flowers, Fruits, and Leaves*. London. The Macmillan Co. 1886. \$1.25.
- MACBRIDE, T. H.
- (1) *The North American Slime Molds*. New York. The Macmillan Co. 1899. \$2.25.
  - (2) *Lessons in Elementary Botany*. Boston. Allyn & Bacon. 1896. 80 cents.
- MACDOUGAL, D. T.
- (1) *The Nature and Work of Plants. An Introduction to the Study of Botany*. New York. The Macmillan Co. 1900. 80 cents.
  - (2) *Practical Text-book of Plant Physiology*. New York. Longmans, Green, & Co. 1901. \$3.00.
  - (3) *Elementary Plant Physiology*. New York. Longmans, Green, & Co. 1902. \$1.20.
- MACILVAINE, C., and MACADAM, R. K. *One Thousand American Fungi*. Indianapolis. Brown-Merrill Co. 1902 and later. \$5.00.
- MASSE, G. *Text-book of Fungi, including Morphology, Physiology, Pathology, Classification, etc.* New York. The Macmillan Co. 1906. \$2.00.
- MÜLLER, H. Translated by D. W. THOMPSON. *The Fertilization of Flowers*. London. The Macmillan Co. 1883. 21s.
- MURRAY, G. *Introduction to the Study of Seaweeds*. New York. The Macmillan Co. 1895. \$1.75.
- Nature*. A Weekly Illustrated Journal of Science. London. The Macmillan Co. £1. 10s. per year.



*Nature-Study Review*. Published by F. L. Charles, Urbana, Ill., in 9 numbers. \$1.00 per year.

NELSON, A. *New Manual of Botany of the Central Rocky Mountains (Vascular Plants)*. By J. M. COULTER, revised by AVEN NELSON. New York. American Book Co., 1910.

NEWELL, JANE H. *Outlines of Lessons in Botany*. Parts I and II; with Readers, Parts I and II. Boston. Ginn & Co. 1892-1893. Outlines, 50 and 80 cents; Readers, 60 cents each.

*New Phytologist*, Cambridge, England. Published at the Botany School in 10 numbers per year. 10 shillings.

OSTERHOUT, W. J. V. *Experiments with Plants*. New York. The Macmillan Co. 1905. \$1.25.

PEIRCE, G. J. *A Text-book of Plant Physiology*. New York. Henry Holt & Co. 1903. \$2.00.

PENHALLOW, D. P. *A Manual of the North American Gymnosperms*. Boston. Ginn & Co. 1907. \$4.50.

PEPOON, H. S., MITCHELL, W. R., and MAXWELL, F. B. *Studies of Plant Life*. Boston. D. C. Heath & Co. 1900. 50 cents.

PFEFFER, W. Translated by A. J. EWART. *The Physiology of Plants*. Oxford. Clarendon Press. Vols. I-III. 1900-1906. \$17.75.

PINCHOT, G. *A Primer of Forestry*. Washington. Government Printing office. 1899 and later. Part I, The Forest; Part II, Practical Forestry. 1905. 30 cents.

*Plant World*. Published monthly at Tucson, Arizona. \$1.00 per year.

RANDOLPH, HARRIET. *Laboratory Directions in General Biology*. New York, Henry Holt & Co. 1898. 80 cents.

*Rhodora*. Monthly. New England Botanical Club. Boston. \$1.00 a year.

ROBINSON, B. L., and FERNALD, M. L. *A Handbook of the Flowering Plants and Ferns of the Central and Northeastern United States and Adjacent Canada*. [Seventh edition of GRAY'S *New Manual of Botany*.] New York. American Book Co. 1908. \$2.50.

SACHS, J.

(1) Translated by GARNSEY and BALFOUR. *History of Botany*. Oxford. Clarendon Press. 1890. \$3.25.

(2) *Lectures on the Physiology of Plants*. Translated by H. M. Ward. Oxford. Clarendon Press. 1887. (Now out of print.)

SARGENT, C. S.

(1) *The Silva of North America*. 14 vols. Boston. Houghton, Mifflin & Co. 1891-1902. \$350.00.

(2) *Manual of the Trees of North America* (exclusive of Mexico). Boston. Houghton, Mifflin & Co. 1905. \$6.00.

SARGENT, F. L. *Corn Plants*. Boston. Houghton, Mifflin & Co. 1899. 75 cents.

SCHIMPER, A. F. W. Translated by W. R. FISHER. *Plant Geography on a Physiological Basis*. Oxford. Clarendon Press. 1903, \$12.75.

SCHNEIDER, A.

(1) *Guide to the Study of Lichens*. Boston. Knight and Millet. 1898. \$2.50.

(2) *A Text-book of General Lichenology, with descriptions and figures of the genera occurring in the Northeastern United States*. Binghamton, N.Y. W. N. Clute. 1897.

*School Science and Mathematics*. Published at Chicago, in 9 numbers per year. \$2.00.

*Science*. Weekly. New York. The Macmillan Co. \$5.00 a year.

SCOTT, D. H. *Studies in Fossil Botany*. London. A. and C. Black. 1900 and later. 10s. 6d.

SEDGWICK, W. T., and WILSON, E. B. *General Biology*. New York. Henry Holt & Co. 1886. \$2.00.

SETCHELL, W. A. *Laboratory Practice for Beginners in Botany*. New York. The Macmillan Co. 1897. 90 cents.

SMALL, J. K. *Flora of the Southeastern United States*. New York. Published by the Author at the New York Botanical Garden. 1903. \$3.60.

SMITH, J. *Dictionary of Popular Names of Plants which furnish the Natural and Acquired Wants of Man, etc.* London. The Macmillan Co. 1882.

SOLEREDER, H. Translated by L. A. BOODLE and F. E. FRITSCH and revised by D. H. SCOTT. *Systematic Anatomy of the Dicotyledons*. Oxford. Clarendon Press. 1908. 2 vols. \$15.50.

SOLMS-LAUBACH, H. GRAF ZU. Translated by H. E. F. GARNSEY, revised by I. B. BALFOUR. *Fossil Botany*. Oxford. Clarendon Press. 1891. \$5.00.

SORAUER, P. Translated by F. E. WEISS. *A Popular Treatise on the Physiology of Plants*. London. Longmans, Green, & Co. 1895. \$3.00.

SPALDING, V. M. *Guide to the Study of Common Plants. An Introduction to Botany*. Boston. D. C. Heath & Co. 1893 and later. 90 cents.

SPOTTON, H. B. *The Elements of Structural Botany*. Toronto. Gage & Co. 1889 and later editions.

STEVENS, W. C.

(1) *Introduction to Botany*. Boston. D. C. Heath & Co. 1902. \$1.25; with Flora, \$1.50.

(2) *Plant Anatomy, from the standpoint of the development and functions of the tissues, and handbook of micro-technic*. Philadelphia. P. Blakiston's Son & Co. 1907. \$2.00.

STRASBURGER, E. Translated by W. HILLHOUSE. *Handbook of Practical Botany for the Botanical Laboratory and Private Student*. New York. The Macmillan Co. 1886 and later. \$2.50.

(STRASBURGER, E., NOLL, F., SCHENCK, H., and KARSTEN, G. Translated by W. H. LANG. *A Text-book of Botany*. New York. The Macmillan Co. 1908. \$5.00.)

*Torreya*. New York. Published monthly by the Torrey Botanical Club. \$1.00.

TUBEUF, K. FREIHERR VON. Translated by W. G. SMITH. *Diseases of Plants induced by Cryptogamic Parasites*. New York. Longmans, Green, & Co. 1897. \$5.50.

UNDERWOOD, L. M.

(1) *Our Native Ferns and their Allies*. New York. Henry Holt & Co. 1881 and later. \$1.00.

(2) *Molds, Mildews, and Mushrooms*. New York. Henry Holt & Co. 1899. \$1.50.

VERWORN, M. Translated by F. S. LEE. *General Physiology*. New York. The Macmillan Co. 1899. \$4.00.

VINES, S. H.

(1) *Lectures on the Physiology of Plants*. Cambridge. University Press. 1886. \$5.00.

(2) *Elementary Text-book of Botany*. New York. The Macmillan Co. 1898. \$2.25.

WALLACE, A. R.

- (1) *Malay Archipelago*. New York. The Macmillan Co. 1898. \$2.00.
- (2) *Tropical Nature and other Essays*. London. The Macmillan Co. 1878.

WARD, H. M. *Disease in Plants*. New York. The Macmillan Co. 1901. 75 cents.

WARMING, E.

- (1) Translated by POTTER. *A Hand-book of Systematic Botany*. New York. The Macmillan Co. 1895. \$3.75.
- (2) Assisted by M. VAHL. Translated by P. GROOM and I. B. BALFOUR. *Ecology of Plants, and Introduction to the Study of Plant Communities*. Oxford. Clarendon Press. 1909. \$3.25.

WARREN, G. F. *Elements of Agriculture*. New York. The Macmillan Co. 1909. \$1.10.

WATERS, C. E. *Ferns. A Manual of the Northeastern States*. New York. Henry Holt & Co. 1903. \$3.00.

WEED, C. M. *Seed Travelers*. Boston. Ginn & Co. 1898. 40 cents.

WILLIS, J. C. *A Manual and Dictionary of the Flowering Plants and Ferns*. Third edition. Cambridge University Press. 1908. 10s. 6d.

50

## IX. ON SOME COMMON ERRORS PREJUDICIAL TO GOOD BOTANICAL TEACHING

ONE of the chief obstacles to the advancement of knowledge is the difficulty of securing the introduction of the results of new researches into general circulation, especially when these are in contravention of commonly-accepted views. Errors once in possession of the field, especially if backed by the authority of some great name, persist long after they are disproven, particularly when easier to understand, or pleasanter to believe, than the newer truths. I shall here point out some of the more prevalent errors in Botany, not including cases still in doubt, but only those on which specialists agree.

Very widely spread is one popular error about Botany, namely, that it is synonymous with the study of flowers, and hence of no great value except as an accomplishment of fashionable boarding-schools for girls, or an appropriate hobby for elderly persons of leisure. This belief is a natural one, for until lately it *has* consisted in this country largely in the study of flowers, and still does to a considerable extent. We cannot expect the error to be corrected until botanical courses represent, in some measure, the real condition of the science.

Another popular error, which, however, is not limited to Botany, but extends to all scientific study, is that implied by the familiar question, "Of what use is it all?" The inquiry is perfectly natural, but to it there are three sufficient answers. First, scientific study gives happiness to some people, who are as much entitled to their own kind of uplifting enjoyment as are those who take pleasure in literature, art, music, or the drama; and their preference should receive the same sympathy and respect as are accorded the latter. Second, man rises in the cosmical scale chiefly through effort, and, next after conquest of himself, scientific investigation of the world about him offers the most natural, worthy, and effective field for the uplifting employment of his powers. Third, the history of science has shown that those scientific discoveries which have resulted in great practical benefit to mankind have been made in the most unexpected places, even in the most unpractical subjects; and it is quite impossible to predict where, on the broad surface of expanding knowledge, the next practical development may spring forth. Hence, the only logical way is to encourage the advancement of all phases of knowledge,—trusting with a faith born of experience, that sooner or later some result will appear of such value as to pay many-fold for it all. Whensoever, in any community, there arises a man with ability and willingness to devote himself to recondite and unpractical scientific researches, the first thing that

community should do is to return thanks in its heart for a piece of good fortune vouchsafed it, and the second is to give him every possible aid, encouragement, and sympathy in whatsoever direction he may elect to follow.

Another error, prevalent among some college teachers, is the belief that Botany cannot be taught as a science in the high schools, because high school students are not mature enough to think in a scientific manner. It is true that many of them do not think, but this is because their power to do so is aborted by disuse, or crushed to earth by the weight of incessant memory work. But experience shows that, given a fair chance, high school students are fully able to profit by a reasonably scientific treatment of the subject.

Still another error, all too prevalent among college teachers, is the belief that valuable educational exercises can be developed from one's head alone without any need for an actual test in class room or laboratory. In consequence our educational literature exhibits some learned but unpractical books for high schools written by university professors, occasional sweeping condemnations of our present laboratory courses conjoined with recommendations for their replacement by wholly untested substitutes, and many uneconomical or impossible exercises in even our best books. There is nothing which does more harm to our science teaching than this positive recommendation of untried matters by those in positions of authority, for the failure of most of these

methods to work out in practice tends to disgust both teachers and students with scientific study.

These, however, are but minor errors, though it is well for the teacher to be on the watch for them, and to attack them whenever they appear. Much more serious are the errors of botanical fact and interpretation current among teachers themselves, and of these the more important concern some leading matters in morphology and physiology.

In morphology some errors of fact still persist, though they are vanishing. Thus the ovule is still sometimes said to represent a part of the altered carpellary margin, a leaf-tooth, as it were, while pollen is said to represent the soft parenchyma inside a leaf. Nothing, however, could be more completely disproven, for we know that the essential parts of both ovule and pollen are in fact spores, — structures not only morphologically wholly independent of leaves, but of an ancestry more ancient than that of the leaves themselves. Furthermore, it is known that carpels and stamens are not modified green leaves, as still sometimes taught, but altered sporophylls, — leaves, it is true, but an independent sort as old as the green leaves and perhaps older. It is, therefore, quite impossible to homologize the parts of carpels and stamens with any parts possessed by a green leaf. But aside from these errors of fact, there still prevail many errors of interpretation, imposed by the rigidly formalistic morphology which is



still in vogue in some places, though as a whole we are outgrowing it. Thus, it has been taught that the higher plant has only these elemental members, — root, stem, and leaf (with perhaps also “plant hair”), and that every part of it is always composed of some one, or some combination of these. On this basis every part of the flower and fruit was homologized with stem and green leaf, even to the uttermost parts, and all inferior ovaries were supposed to be carpels enwrapped by calyx. The central idea of this morphology was a belief in the immutable nature of the plant members, or elements, which, like the chemical elements, might be variously combined and united, but must retain their identity through all the changes of form and function. But further study has shown that this view is wrong, and that there are no ideal natures imposed upon structures, other than such as they possess through long repetition of one habit. On the contrary, difference of degree in development passes over gradually into difference of kind, thus leading to the formation of new elements or members, which become centers of independent variation, modification, and adaptation upon their own account. Thus, an ovary, when varying adaptively to some new influence, does not need to go back to consult the rules governing its behavior when it was a set of leaves (sporophyls), but it responds as a new unit, an independent member or morphological element,— in a word, not as sporophyls but as ovary. It is

not possible, therefore, to homologize all the peculiarities of inferior and superior ovaries, and their diverse sorts of placentæ, and anything that leaves exhibit. There exists in morphology the same distinction between historical origin and present nature which occurs among peoples. Historically, an American is an Englishman, but he does not on that account now act or think as an Englishman; he has a new character, he is an American. And just as the American has attained to independent political dignity, so a plant structure, through time and change of habit, can attain to independent morphological dignity. Of course there are all degrees of this morphological independence, and while some structures have broken away entirely from their original nature, others are more or less bound by it; but the recognition of the principle, really the fundamental principle of modern morphology, is very important. Formalism in morphology based upon abstract conceptions, is being replaced by realism based upon observation of things as they are.

Another old morphological error, which occasionally reappears, concerns the supposed composition of the higher plant from certain elemental parts called phytomera, each composed of a joint of stem and one or more leaves. The support for this idea is found partly in the jointed appearance of many plants like grasses, and partly in the fact that the so-called phytomer is usually the smallest part of a plant that will grow. The latter, however, is

a purely physiological phenomenon of no morphological significance; a piece of stem can usually put out roots, and some leaf surface is necessary to make food to enable the plant to continue its growth. The jointed appearance is purely incidental; the nodes are the places where the fibrovascular bundles branch to run out into the leaves and to unite with one another, and hence the node and its accompanying internode have simply an anatomical and not a morphological meaning. Embryology shows that the plant is not made up of a series of phytomera growing one out of another, but of continuously-growing vegetative points which throw off leaves and branches at regular intervals. Again, it is usually assumed that root, stem, and leaf of the higher plant are members of equivalent morphological worth. In fact, this is not the case, for root is in every way much more distinct from stem and leaf than these are from one another. The best division is into root and shoot, with the latter differentiating into leaf and stem. But even this does not go back far enough, for we must recognize the spores in any morphological classification, and certainly the spores are more distinct from root and shoot than these are from one another, as the lower plants (*e.g.* the Algæ) well show. The relationships of these members are shown by the table on the following page.

The statement that an inferior ovary is one in which the calyx tube is adnate to the carpels is likely to persist

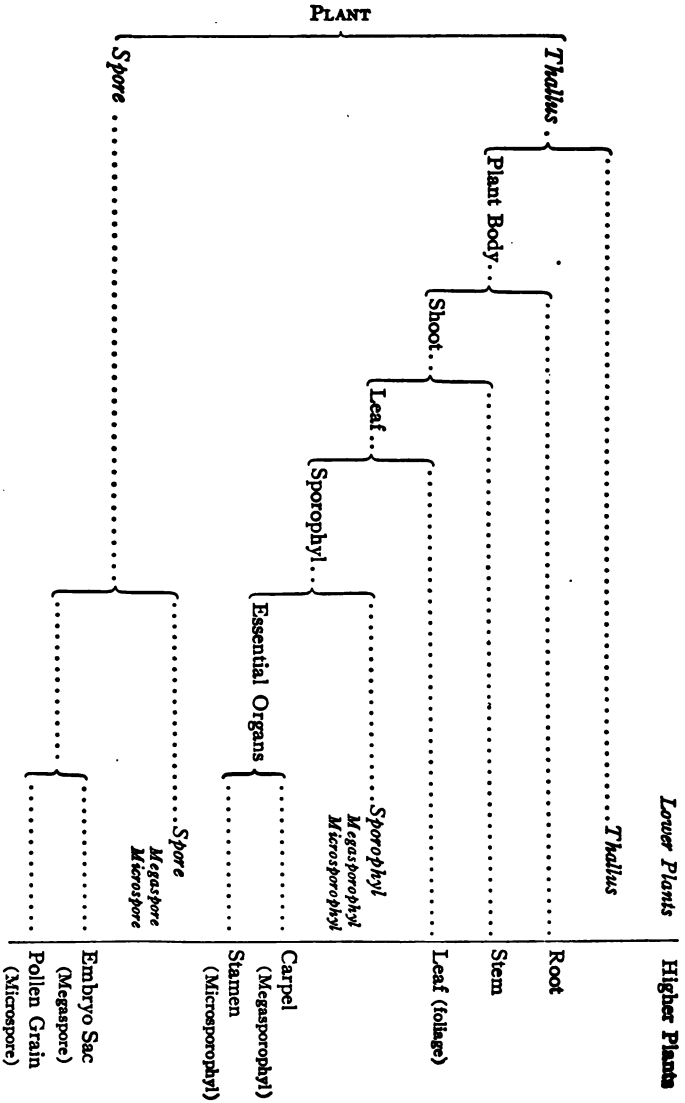

in works on classification, since it is inseparably bound up with the technical terminology of that subject. But the teacher should know that it is in fact incorrect. Embryology shows that, in the great majority of cases at least, the inferior ovary is simply a receptacle which has grown up into a cup, carrying all the other parts upon its top; the carpels come finally to form simply a roof over the cavity of the ovary (as shown in Fig. 34), a fact which at once disposes of many of the inconsistencies inseparable from the "calyx-adnate" theory. Again, where a tube is formed in calyx, or corolla (or perianth), it is usual to consider that this tube consists of united sepals, petals, etc., but it is probable that only the free parts, or teeth, of the corolla or calyx represent the original distinct petals or sepals, while the tube is a band of leaf tissue that grows up as a ring leaf, bearing the separate leaves on its top; it is thus a new development of the corolla or calyx, precisely as the corona is, and not the united bases of the old perianth parts.<sup>1</sup>

An error still very widespread is the belief that monstrosities are reversions to an earlier condition, and hence good guides to the past history of organs or species. It is true they may be, and of course often are, reversions; but so frequently they are not that great caution must be

<sup>1</sup> If the reader cares to follow this subject farther, he may be interested in a more detailed discussion of the principles of morphology which I have published in the *Botanical Gazette*, 31, 1901, 426. There is a companion paper, relating to ecology, in *Science*, 19, 1904, 493.

exercised in using them as guides to phylogeny. If the turning of a rose petal green is taken to prove that the petal was once a foliage leaf, then the turning red or yellow of the leaf under the flower of a tulip is equally good evidence that this leaf was once a petal, which is, of course, not to be believed. In fact the turning green of petals means nothing more than a disturbance of nutrition conditions. This principle applies to the cases where carpels become leaves and the ovules leaf-like bodies, which need not mean that these were once of a green leaf nature, but only that the plant has for some reason unknown built green leaf tissue instead of carpellary tissue at that place.

Much more common than morphological errors are those of physiology, of which some are popular and some technical. Of the popular sort the most widespread is the belief that animals and plants are the exact opposites of each other with reference to the taking in and giving off of the two very important gases, carbon dioxide and oxygen. In a general way this is true, but not in the sense in which it is usually meant. In fact, in all of their processes of growth, movements, etc., animals and plants behave precisely alike with reference to these two gases, in both cases taking in oxygen and giving out carbon dioxide. That is, both animals and plants respire, and exactly alike. But it happens that green plants have an additional power, utterly lacking in animals, to form their food from

certain gases, minerals, and water; and in this process (photosynthesis, or carbon assimilation), carbon dioxide is absorbed and oxygen is given off. In green plants in bright light, this process is so very much more active than the process of respiration (about a dozen times in leaves on a bright day) that the plant as a whole does give off much more oxygen than carbon dioxide; but in darkness the food making stops, while the plant continues to give off carbon dioxide precisely as before. It is, therefore, only by virtue of their possession of this single extra power of photosynthesis that plants reverse the process of animals; in nearly all others of their important vital actions the two kinds of organisms behave just alike.

Much misunderstood is the nature of plant food, which is commonly supposed to consist of carbon dioxide, minerals, and water. If by food one means anything taken into and used by the organism, this popular idea is correct; but if by that term one means the substance out of which the organism builds up new tissues, repairs waste, and obtains energy for its vital work, then it is incorrect. The fact is, as just mentioned, that the plant has the power of absorbing carbon dioxide, water, and minerals, and of making from the two former a new substance, a sugar, which is then used as food by plants in essentially the same manner as animals use the materials they eat. Or we may express the matter thus: Plants form their food from raw materials, which properly are

not food at all, but animals have no such power and, therefore, must obtain theirs ready-made from plants.

A good many people who have watched plants a great deal have the idea that they possess a certain amount of intelligence, and there is at least one book devoted to an attempt to demonstrate the truth of this. Even the scientifically-trained student, in his first studies upon the irritability, or individual adaptive responses, of plants, usually passes through a stage in which he is almost persuaded that plants possess a rudimentary intelligence. The more careful study of the phenomena, however, has shown that plants do not possess any traces of intelligence, and that the power by which they produce some apparently similar results, *i.e.* their irritability, is more nearly comparable with reflex action, and even with instinct, in animals, than with consciousness and intelligence. It seems a fact that out of one and the same property in the original protoplasm, animals have differentiated reflex action, instinct, and intelligence, while plants have developed only irritability.

In addition to these popular errors there are some which are current among teachers, and even among the writers of our most authoritative text-books. A number of these are connected with photosynthesis. Thus, some of these books recommend, with a suitable illustration, an experiment in which bubbles of oxygen are said to rise copiously from the leaf of a land plant, lettuce or the



like, when placed under water in a tumbler and stood in the sun; but in fact, this is wholly an error. The bubbles are not oxygen at all, but air dissolved in the water and released by the rising warmth. They collect on the sides of the dish as well as on the leaf, on dead leaves as well as on living ones, and in darkness as well as in light when the temperature is raised as high, while analysis shows that the gas contains no more oxygen than belongs to air in solution. And besides, the bubbles do not rise unless the dish is shaken. In fact, by this method oxygen can be collected only from plants which live under water, *e.g.* Cabomba, Elodea, etc. Even in connection with this experiment most of our books introduce an error; namely, they picture the funnel under which the water plants are placed as either resting on the bottom of the containing vessel, or else completely filling it when of cylindrical form. But as a matter of fact, in such case, the supply of carbon dioxide in the funnel is soon exhausted, and no more oxygen can be evolved. The only way to insure success is to use a large dish with plenty of surface through which additional carbon dioxide can be absorbed from the air, and to keep the funnel well up from the bottom. Equally fallacious is another experiment still found in most of our elementary books, viz. that in which, to demonstrate the necessity for light in starch formation, corks or pieces of tin foil are pinned to the opposite sides of a leaf,—the effect exhibited when the iodine test is applied after ex-

posure of the leaf being supposed to be due to the absence of light. In fact, it is due as much to the absence of carbon dioxide excluded by the lower cork, even when this is loosely applied, a fact readily shown by control experiments. The ideal way to perform this experiment is this: to apply the opaque object only to the upper surface, where there are usually few or no stomata (preferably selecting a leaf with none above), and to cover the corresponding lower surface with a perfectly-ventilated dark box, which will permit free access of the carbon dioxide to the stomata. An error of somewhat similar sort is involved in the method often recommended for proving that plants can make use of the carbon dioxide of the atmosphere for making starch. Two similar plants are placed under separate bell-jars to which access of the atmosphere is allowed, in one case through a carbon-dioxide-absorbing substance and in the other through a mechanically-similar but chemically-neutral material. But in fact, when used in this way, the materials practically stop all communication with the atmosphere, and the results are imperfect or wholly negative. The experiment can be perfectly performed by using large sealed jars or bottles with single small leaves, as I shall describe in the suitable place in Part II of this book.

Among other physiological errors I shall here mention but a few of the worst, leaving the minor ones to be noted under the appropriate sections in Part II. **That**

all books are hopelessly confused as to the difference between root exudation (or bleeding) and root pressure, two very different phenomena; and they recommend for the determination of pressure the use of open mercury gauges of several millimeters' diameter, which not only require a large amount of exudation to push the mercury up to any appreciable height, but also are of such proportions that only a fraction of an atmosphere can be registered before the water pushes past the mercury. In fact, there is no relation whatever between the quantity of water given off, and the pressure under which it is given off, and often the quantity is very small, though its pressure is high. In such a case, when a large gauge is used, the quantity is enough to push the mercury only a short distance, which would be taken to mean a very low pressure. The remedy is to be found in the use of gauges so small in bore and length that the pressure is indicated by an inappreciable quantity of water. For this purpose small closed gauges, in which the pressure is calculated by Boyle's law, are best. Again the extinguishment of a candle inserted into a closed space is sometimes assumed to prove the presence of carbon dioxide, whereas it may mean this, or it may mean the presence of any other neutral gas, or it may mean simply a deficiency of oxygen. Again, it is sometimes said that by means of a flame the oxygen may be burned from a confined space and replaced wholly by carbon dioxide, and I know a book devoted to

the chemistry of plants which gives supposedly experimental evidence in support of this error. In fact, an ordinary flame will not burn as a rule over about three per cent of the oxygen from a confined space before it goes out.

It would seem upon *a priori* grounds impossible for such errors to obtain general currency in good books, and the fact that they do illustrates the imperfections of the human mind as an instrument for the advancement of knowledge. As a rule, the errors originate in somebody's carelessness, perhaps in his recommendation of an experiment devised in the study arm chair, and never properly tested in the laboratory. Then they are perpetuated through our slavish reverence for authority, which has so great a grasp upon us, that when we do seriously test an experiment, we usually feel bound to make the result come as stated; and we even blame ourselves, and not the original author (and much less the phenomena of nature), when these results fail to come as advertised. Besides, we are usually perfectly satisfied when a result comes according to expectation, never stopping to ask whether that result may not be only accidentally instead of logically correct, something which would never be possible, if we but employed in demonstration the same critical-control spirit we always use in an investigation.

<sup>1</sup> The reader interested in this subject of current physiological errors will find a more detailed treatment of it in an article of mine in *School Science and Mathematics*, 6, 1906, 297.

Our working botanical vocabulary includes some terms which the progress of knowledge has rendered unfortunate, if not erroneous. Thus "cross fertilization," as applied to the transfer of pollen by insects, should be avoided, for fertilization is the actual union of the male and female elements to which the transfer of pollen is merely a mechanical preliminary. "Cross pollination" is a good term. Again I am myself responsible for the unfortunate phrase "locomotion of seeds" sometimes applied to their scattering by the agency of animals, etc. The term was first used to express the idea that the process attains the same physiological or ecological result as does locomotion in animals; but it involves a misleading implication as to the method, and I think the old term "dissemination" is much better, even when extended to the entire process, including cases of real locomotion. Another unfortunate phrase is "cambium ring," which ought obviously to be replaced by "cambium cylinder," while stomata ought never to be called "breathing pores," since plants, while they respire, do not breathe. I have already pointed out the unfortunate use of the term "plant food," though usage is probably too firmly fixed for change, but we can at least make the distinction between "raw food" and "elaborated food," or between "food elements" and "food." However, it is entirely possible to carry these refinements of terminology too far, an example of which, in my opinion, is the custom of some morphologists to

restrict the terms "sex-organs" to parts of the gametophyte generation (contents of the embryo sac and of the pollen grain), and to deny it to the sporophyte generation, which includes the stamens and carpels. Such a restriction is not only an arbitrary attempt to wrest a popular terminology from its old and perfectly defined meaning, and give it a limited technical meaning, but it is, in my opinion, incorrect in fact, since it is based on the assumption that morphological and physiological lines are coincident, whereas they are wholly independent of one another. So I think it is perfectly correct to call stamens the male organs, and pistils the female organs of the plant.<sup>1</sup>

We may take advantage of this opportunity to consider briefly a matter which, while not an error, involves some of the same consequences. No teacher works long among plants without learning that instead of the single scientific name which each plant is supposed to possess, many plants apparently have several; and a little later he discovers that in this country there exist two warring schools of plant nomenclature, whose writings have brought the subject into so much confusion that the common names of plants have actually been, of late, more stable and distinctive than the scientific. The origin of this strange condition is too complex for discussion in this place except in barest outline. All working botanists, from the

<sup>1</sup> My argument in full on this subject is in *Science*, 17, 1903, 652. No reply thereto has been published as far as I have seen.

time of Linnæus to our own, have agreed that a plant shall have but one scientific name, which shall be that first given. For various reasons, however, a name later given had in many cases superseded the earlier, and there were all kinds of troublesome intermediate complications, on the treatment of which usage was divided. Finally, about twenty years ago, a group of the younger American botanists attempted to solve all these troubles by returning, in every case, to the first name given, holding that present inconvenience in the changing of many fixed names would be much more than compensated by ultimate stability and uniformity. These changes were resisted by others, who desired to retain the great body of existent names, even though these were not the first given; and these botanists had developed rules for the consistent treatment of all the doubtful cases. The rules of the former, often called the Neo-American, school, are embodied in the *Manual* and other works of N. L. BRITTON, while those of the latter, or Grayan School, are embodied in the sixth edition of GRAY'S *Manual*. The original merits of the controversy, however, are not now so important as they were, because, in June, 1905, the whole subject was discussed by an International Botanical Congress held at Vienna, with conclusions expressed in a majority vote. All matters at issue had been submitted to the members of the Congress long enough before the meeting to allow of full consideration, and at the Congress itself every oppor-

tunity was given to all persons to advocate the merits of their respective views. The result of the majority vote was, of course, a compromise, but while it went against the usage of the Grayan School on some points, it went far more heavily against the Neo-American School, and on the most distinctive features of their system. Since the Congress, the leaders of the Neo-American School have announced their intention to abide substantially by their own system, but the leaders of the Grayan School have declared their intention to conform to the decisions of the International Congress in every particular. Recently the Grayan leaders have brought out the seventh edition of GRAY'S *Manual*, which embodies completely the decisions of the Congress, and is the first American work to do so. This book, therefore, with its sanction of international approval, gives promise of stability in nomenclature, so far as the plants within its range are concerned, and any future changes should be due to advance of knowledge of plant classification, and not to extraneous manipulation of their names.

Many matters are thus in transition in our science, but the possibility of watching, and, yet better, of taking part in, the constant progress towards better knowledge, is one of its greatest charms.



## PART II

*OUTLINES AND DIRECTIONS FOR A  
SYNTHETIC GENERAL COURSE IN THE  
SCIENCE OF BOTANY*

The first part of the paper deals with the general principles of the treatment of the various forms of insanity. The author discusses the importance of a thorough physical examination and the use of the most modern methods of diagnosis. He also touches upon the question of the treatment of the different forms of insanity, such as melancholia, mania, and dementia.

REFERENCES

- 1. *Journal of the Royal Society of Medicine*, 1911, vol. 4, p. 100.
- 2. *Journal of the Royal Society of Medicine*, 1911, vol. 4, p. 100.

The second part of the paper is devoted to a detailed description of the various forms of insanity. The author discusses the symptoms, signs, and course of the different forms of insanity, and also the methods of treatment. He also touches upon the question of the prognosis of the different forms of insanity.

The author concludes his paper by stating that the treatment of insanity is a very difficult task, and that the most important thing is to have a thorough knowledge of the different forms of insanity, and to be able to recognize them in their early stages.

## INTRODUCTION TO PART II

THE principles which have controlled the construction of these outlines have been set forth fully in the preceding chapters, but it will be worth while to summarize them here. The ideal is to guide the student to the optimum return of sound scientific training and thorough botanical knowledge for the time and strength he can put into the work. Hence the outlines are a study in educational economy, with three principal phases: *first*, the selection of the most vital and illuminating topics from the various divisions of the science; *second*, the introduction of the topics in such an order as will make them throw most light upon one another; *third*, the presentation of the topics in a form found best for drawing out the efforts and interest of students of the age usual in such a course. The outlines have been worked out in the actual laboratory practice of a good many years, with constant account of practical considerations of expense, time, and arrangement of the school and college year.

The general plan of the entire course is the double ~~one now~~ approved by experience, used by most teachers, embodied in our most authoritative text-books and

standard courses. The first division treats of the leading facts of plant structure and function; that is, of morphology including anatomy, and of physiology with ecology. The second division considers the particular structure, habits, reproduction, and relationships (those subjects grouped under the old term of Natural History), with the economics of plants in the principal groups from the *Algæ* to the *Spermatophytes*.

In Division I a beginning is made with large, simple, somewhat familiar objects, requiring no tools, but only the undivided attention of eye and thought. It is sought first to develop the scientific or inductive habit of thought, with the correlated use of observation, comparison, and experiment. Tools are gradually introduced, the simpler first, while the less familiar instruments, materials, and topics follow later. The physiological experiments, arranged to be tried with apparatus designed especially for demonstration, are generally introduced in connection with the study of the particular organs upon whose structure they throw most light. New topics are presented to the student, as a rule, in the form of problems so arranged as to be solved through proper inductive processes by his own efforts; and thus the topics form a series of subjectively original investigations. These problems are introduced by questions asked in a form to which much study has been devoted. Indeed, the form of the questions is one of the most important features of such outlines

as these, for through them the student's energy may be conserved, his attack on his problems may be made effective, and much both of stimulus and suggestion may be conveyed. It is by no means only the easiest or most familiar topics and experiments which are here recommended, but a direct attack has been made upon the most fundamental and important.

Since it is of the utmost importance to a correct conception of the meaning of the modern science of Botany that the student's introduction to it should be made through the study of plants alive and at work, and since, in our climate, and especially in city schools, much accurate field work is impracticable, the tracing of some living plant, which can be grown in house or greenhouse, through its life cycle, forms the best beginning known to me. Since plants develop from the seed with relative rapidity, and the phenomena of their growth, movements, etc., can readily be seen and experimented upon, the germination of the seed, introduced by a study of the seed itself, affords a very effective starting point. After a single plant has been followed through its cycle from seed to seed, the modifications of this typical form, in response to the different habits, are taken up, and then the different members — leaf, stem, root, flower, fruit — are studied in detail as to their structure and functions. Practically, the leading botanical phenomena may be worked out best in the higher plants, because these are larger, more famil-

iar, and easier to obtain and to keep alive, than are most of the lower kinds.

In Division II, living plants which may be studied alive and which, in many cases, may easily be seen in their native haunts, where attention can be called to their habits, are used whenever possible. With the knowledge and training acquired in Division I, the students work through this second division with much facility and profit, and it is by no means inferior in value to the former. Here the lower, or cryptogamic, plants receive their proper attention, and here, too, is the rightful place of classification. In these outlines I have retained the plan of proceeding from the lower to the higher forms, but I do so because this fits best with the availability of materials through the year. Were this condition not determinative, and, in any case, if the course began with Division II, I should certainly reverse this order and begin with the higher forms.

In using these outlines it is by no means expected that any teacher will try to follow them exactly; although at the same time, in view of the amount of careful trial and experiment which has brought them into their present form, one should have good reasons for the changes he makes. Of course many practical considerations are likely to make it impossible to provide the exact materials called for, or to take up the topics or experiments in order. For this reason I have not attempted to arrange the outlines to fit definite weeks of work, but have grouped the

exercises by subjects, which themselves follow in an order partly natural and partly adaptive to the conditions of the school or college year. Indeed, it is in general very hard to provide the materials to fit any particular set of outlines, and it is much easier and more logical to make outlines to fit the materials. These outlines are, therefore, primarily a series of suggestions, based on considerable experience, representing useful selection and treatment of topics and expression of problems. They may serve as a basis or as models for the teacher in the construction of new outlines of his own, which may differ from these as little, or as much, as he finds best. Certainly, I think, a special outline should be drawn up by the teacher each week to fit his particular mode of teaching, the material available, and the state of advancement of his class ; and a copy of this should be placed before each student, who should be held responsible for the complete working out of all that is called for upon it. Directions for details of study must be given the students by the teacher ; when given verbally, some students do not hear them, and others forget them, but the written outline keeps them before all. So great is the advantage of these weekly guides in economizing the teacher's time and strength, and in giving definiteness and direction to the student's work, that there is, in my experience, no teaching device of greater worth. There is not the slightest objection to them on the score of weakening the student's self-reliance,

and when given a proper form, they can be made a real stimulus. They deliver the teacher completely from that otherwise-familiar and ever-harrowing question, "What do you want me to do next?" Such outlines do not, of course, replace the general introduction, and the summaries given by the teacher from time to time during the laboratory period.

The experiments here given are such as seem to me most illuminating. Experiments much easier to try are available in abundance, but many of them are concerned with comparatively unimportant topics; and it is worth while to go to some extra trouble to illustrate the more fundamental matters. Along with the suggestions on teaching I have treated the physiological experiments in considerable detail, because a knowledge of these subjects is not yet so common as is knowledge of structure and classification.

The entire course as given in the outlines will require a full year of work under more favorable conditions than most of us can command. I must confess that I cannot cover it all with my own classes in a year of thirty-five working weeks, of four hours laboratory, one hour demonstration or recitation, one hour lecture (with two hours outside preparation) each week, though we do not have to omit much. I have not tried especially to keep the outlines within the limits of possible work for a year, but rather I have sought to include all topics which seem suitable to an



elementary course, leaving it to the teacher to select the parts he prefers. Consequently, no teacher need feel discouraged by their length, and imagine that his course, because falling much short of this amount, is, therefore, more deficient than the average.

The course is designed to serve as a unit for entrance to college, but that is not its primary purpose, which is rather to provide a guide to the elements of botanical education for those who go no farther with the subject.

If but half of a year can be given to the subject, the teacher should concentrate upon one of the divisions, and not attempt to select topics from both.



## DIVISION I

### THE STRUCTURE AND FUNCTIONS OF PLANTS

#### I. The Structure of Seeds

1. *a.* Study the outside of the dry Lima Beans; compare several specimens, and determine the features common to all in distinction from those which are individual; minutely observe: —

- (1) What is the typical shape?
- (2) What is the color?
- (3) What are the characteristic markings?

*Answer, as far as possible, by drawings of a typical specimen made twice the natural size; add notes to describe the features which drawing cannot express.*

- b.* Study the soaked beans, and observe the effects of the soaking upon the original size, shape, and markings. Then remove the coat and observe: —

- (1) How many coats are there?
- (2) Do the external markings bear any relation to the structures inside?
- (3) What shapes have the structures inside, and how are they connected with one another?

*Answer as before by drawings and notes, the former natural size.*

2. Study fully in the same way the Horse Bean.
3. In a concise table express the resemblances and the differences between the Lima and the Horse Beans.

**Materials.** — White Lima Beans (*Phaseolus lunatus*) and Horse Beans (*Vicia Faba equina*) (about six of each to a student) may be bought in all large seed stores. String Beans (*Phaseolus vulgaris*) may replace the Lima, and Windsor Beans (*Vicia Faba*) may be substituted for the Horse Beans, and other kinds will do; but those selected should be large, and such that in one the cotyledons come above ground in germination, and in the other they remain below. Half of each kind should be soaked over night.

**Suggestions on Teaching.** — The great merit of this work upon seeds is this: that it affords an exceptionally favorable beginning for training in the elemental scientific faculties of observation and comparison, without any of the complications introduced by the use of unfamiliar materials, manipulation, or tools. Its value, however, from this point of view depends largely upon the skill with which the teacher employs it. No instruments are needed aside from a pocket knife or the scalpels of the dissecting sets.

(1) *On Observation.* — It is of first importance that the student learn to see natural facts absolutely as such, uninfluenced by any explanation of them. Hence he should be kept at work upon the Lima Beans until he has seen clearly (as shown by his drawings, notes, and replies under questioning) these facts, — which of his specimens are average or typical: what their typical shape and color is: the radiat-

ing markings, stopping short of the edge: faint concentric markings (not always visible): the large scar on the concave edge, with a tiny pit at one end, and at the other a minute yellowish triangle, or raised structure, which continues into a faint ridge ending in a more raised portion, the latter making an angle as seen from the side. Observation consists not only in seeing all these things, but in seeing them in their correct relative positions and connections. Neither names for the structures, nor explanations of their meaning, should be given until after the things have been seen, some curiosity aroused as to their use, and a need developed for terms to designate them.

On removing the seed coat, the student should see, — the single coat: the thick line representing the ridge he saw outside: the lack of any connection between exterior markings and the structures inside, excepting only that the micropyle is over the end of the hypocotyl (not of course at first using those terms). In the embryo he should see that the cotyledons are lateral growths from the hypocotyl: and that the plumule consists of a short stalk, itself a continuation of the hypocotyl, bearing two folded veined leaves, one of which is partially inclosed in the other.

(2) *On Comparison.* — The student should see that some cracks and folds are due simply to individual differences in the mode of drying, etc., and that shape and size are variable, though within limits; and he must learn to select a typical specimen for detailed study. In his treatment of Exercise 3 he should be led to distinguish clearly resemblances and differences, and to describe them separately; indeed, the two closely related though superficially dissimilar seeds are introduced for the sake of training of this kind.

(3) *On Representation.* — The general principles underlying this part of the work are discussed in Chapter V. Observation should be made fully before recording is begun. As to drawing, the students should first be given some general guidance and suggestions, but afterwards should be encouraged to do the best they can unaided, judging for themselves how many and what kinds of drawings are necessary to show completely such an object as the seed and its parts. While all needful aid should be given at the start, afterward they should be made to complete a subject the best they can before it is examined or criticised by the teacher, since otherwise they will tend to lean back upon the teacher's aid, and will develop no self-reliance. After they have done their very best, their work should at once be examined, and wherever it is markedly deficient they should be encouraged to look and try again. After they have finally done all they can, the teacher should, step by step while carefully explaining the logic of each point, show them the best way he knows for representing the objects, with which they may compare their own efforts; this may well be done for them all together on a blackboard. They are, after their own trials, in a position to profit by all of the advice thus given. A good representation of the Lima Bean, as it might well be made by a beginner, is shown in Fig. 14, though the faint radiating lines might have been added; and Fig. 15 offers an example of an unusually good drawing in which shading is introduced.<sup>1</sup> But while representation is made thus important, the teacher must not go so far as to develop it into a fetish; for after all it is but a means to an end. At first only clear diagrams should be insisted upon; shading,

<sup>1</sup>This drawing was made by a student of mine, Miss Bertha Bodwell.

etc., may come later. It is, moreover, very important not to insist upon too many things at once, as this tends but to confusion; and earlier exercises may well be left somewhat incomplete for this reason. From the first, all rough sketches had better be forbidden. Few drawings may be made, but in these every line and spot should have its meaning, and nothing

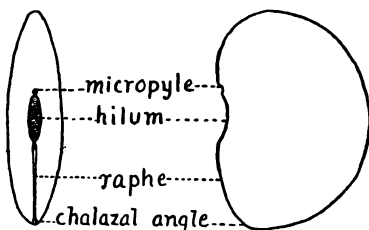

FIG. 14.—Good outline drawing, by a beginner, of Lima Bean; actual size.

should be admitted for which there is not an equivalent in the seed. Outlines should be firm, clear, and complete, and haziness of any kind should not be permitted. The drawings should not be a composite made up from several specimens, but an accurate drawing of a typical specimen. As

for the notes, they should be clear, concise, and well expressed, and should include only such matter as can be expressed better in words than in drawings, never duplicating information conveyed by the latter.

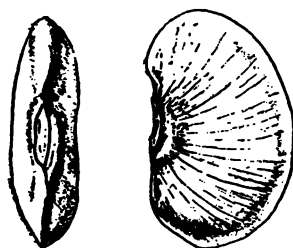

FIG. 15.—Good shaded drawing, by a student, of Lima Bean; actual size.

(4) *On Knowledge of Seed Structure.*—Their observation should teach the students the leading facts of seed structure.

After they have seen and represented the parts, the teacher should lead them to ask what is the use or other meaning of each part; and as they have no data for determining any of

these, except, perhaps, for the hilum, the early life and development of the seed must be briefly described to them with reference to the use of each part. This applies in particular to the markings, for the use of parts of the embryo they will learn for themselves later. Along with this, and after making them feel the need for concise terms to describe the different features, the technical names for the parts should be given, and these terms may be impressed the better upon the minds

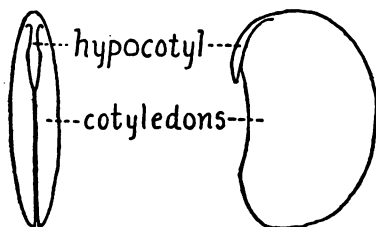

FIG. 16.— Good outline drawing, by a beginner, of embryo of Lima Bean; actual size.

of the students if accompanied by side remarks upon their etymology, etc. Of course names and uses should be carefully recorded with the drawings and notes.

The terms and principal uses to which attention should be called are these;—*Coat* (only one in the bean): *Hilum* (the very obvious scar of the attachment of the seed to the pod): *Micropyle* (the opening through which the pollen tube entered the ovule for fertilization): *Strophiole* (small in some beans, and prominent in others, of uncertain meaning, but generally viewed as a rudiment of an additional seed coat): *Raphe* (a part of the stalk of the ovule grown thereto): *Embryo*: *Cotyledons*: *Hypocotyl* (a better term than *Caulicle*, and far better than the old and misleading term *Radicle*): and *Plumule* (the first bud of the new plant). The *Chalaza*, the place where stalk, coats, and interior part (nucellus) originally came together, and where the stalk (later in part forming the raphe) distributed the nourishment to the other



parts, does not really exist in the seed, although its position can sometimes be determined by a marked angle (which may be termed the *chalazal angle*) at the end of the raphe.

In the demonstrations accompanying the work of this first period the teacher will find it well to take the students into confidence, to an extent and in ways appropriate to their

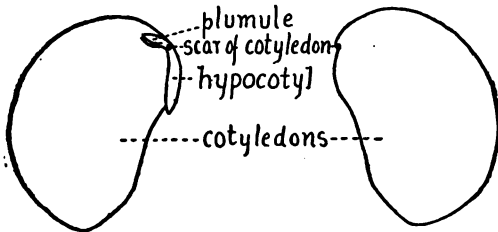

FIG. 17.—Good outline drawing, by a beginner, of embryo of Lima Bean laid open; actual size.

age, as to the general scope and interest of Botany, the value and general method of laboratory work, and the correct attitude towards scientific study. Also, it is an advantage to explain to them, through the intermediation of recalling the facts familiar to everybody about the growth of plants, the logic of beginning their study with the seed and of following the plant through its cycle of growth back to the seed. In connection with drawing, after they have made their own attempts thereat, the teacher should give them an idea of the qualities of good scientific drawing, with illustrations of good and bad kinds.

Seeds form interesting objects for collecting, and therefore may be used as a basis for the development of the collecting instinct, that valuable attribute of the naturalist. This is aside from the value of the collection in itself, which is great.

## II. The Morphology of Seeds and Embryos

4. *a.* Study the outside of a typical specimen of the Horse-chestnut and minutely observe:—

(1) What is its shape, its color, and its markings?

(2) Does it show any structures not in the Beans, or lack any that occur in those seeds?

*b.* Remove the coatings from a soaked seed, and observe:—

(1) How many coats are there, and how are the markings related to structures inside?

(2) What shapes have the parts of the embryo, and how are they connected with one another?

(3) Are there any new parts or features not present in the embryos of the Beans?

*Answer, as before, by drawings and notes. Carefully separate with the fingers all parts that can be forced apart without tearing.*

5. In a similar way study the seed of the Morning-glory.

6. In a similar way study the grain of Corn.

*Where parts cling too closely to be separated by the fingers, use a knife, and try median sections.*

7. *a.* In the form of a concise table, compare as to (*a*) resemblances and (*b*) differences the four kinds of seed you have studied,—the Lima Bean, Horse-chestnut, Morning-glory, and Corn.

- b. Construct a series of four diagrams, showing by corresponding colors the morphologically equivalent parts in the four embryos.

*Choose such a view, the same in all cases, as will bring out the connection between the parts of the embryo. Place this series on the upper half of one page, and leave the remainder for a related series to come later.*

8. A study of the food substances of seeds.

The invariable presence of some food in seeds; the nature of the principal food substances there found, with their characteristics and recognition marks; the experimental demonstration of the commonest kind in the pure state, and as occurring in a half dozen common seeds (Experiment 1); stores of food in other parts of the plant.

*Using the above outline as a guide, but utilizing all of your sources of information, write a synoptical account of this subject, including a clear description of the experiment.*

*All accounts of experiments should distinguish clearly between (a) the object, (b) the method and instruments used, (c) the exact results obtained, and (d) the conclusions derived therefrom.*

**Materials.** — For the purposes of this exercise the Horse-chestnut (*Æsculus Hippocastanum*) is so valuable a seed that every effort should be made to obtain it; and fortunately the tree is grown almost everywhere. In order to make these hard seeds soft enough to dissect readily, they should be

boiled for an hour, allowed to stand in the water for a day, and then dried. The other seeds can be bought anywhere at low prices. Morning-glory (*Ipomœa purpurea*) is the most convenient albuminous seed, for although the Castor Bean (*Ricinus communis*) is better, it is more difficult to obtain, and germinates badly. The Morning-glory can be brought into the best condition for study by a soaking for two days. The Corn must also be soaked for some hours, preferably over night.

**Suggestions on Teaching.** — The object of this work is to continue training in observation of structure, and to make an introduction to comparison, or morphology. After their previous experience, the students will easily find in the Horse-chestnut everything visible on the seed coat, including the fibrovascular bundles on the hilum. They should find the two coats, very different from one another. They should see that the hypocotyl does not lie against the cotyledons as in the Bean, but is separated from them in part by a seeming pocket of the coats (really due to a folding of the young ovule inclosing part of the coats), and that the seeming hypocotyl really splits down part of its length and has the plumule at the bottom of the separable structures. In the Morning-glory they should find (with help of a lens) micropyle and raphe as well as hilum, and the jelly-like endosperm, and the two cotyledons. In the Corn they should see, in addition to the other parts, the remnant of the silk (style), and, by the aid of sectioning, the leaves of the plumule; and on a failure to see these structures they should be reminded not simply to look at things, but also to move and separate them.

Morphology is of the utmost importance in biology. Practically it consists chiefly in recognizing the original structural

nature of parts, no matter how much disguised by changes of size and shape. Its best index is the relative positions of parts. The Horse-chestnut is good to begin with, for the student may be led, through a careful comparison of the construction of its embryo with that of the Bean, to work out the fact that the structure which he at first always takes for "hypocotyl hollowed out with the plumule at the bottom," is really the stalks, or petioles, of the cotyledons, while the hypocotyl is only the part below the plumule. In the Morning-glory he is apt at first to mistake the very leafy cotyledons for plumule, but can be led to work out their true nature. And in the Corn he can thus discover that the shield-like body is probably a cotyledon. (Actually there is some slight doubt on this point among experts, but it is probably true, and can be so treated, with a suitable caution to the students.) His discovery of the remnant of the style on the corn grain, and his inability to find any equivalent for it on the other seeds, may be used to introduce an explanation of the composition of this grain as ovary united to seed; and he can then understand why no micropyle is visible, and that the scar of attachment, while functionally a hilum, is not strictly so morphologically. Sections through the seed will not, however, display seed coats as well as ovary wall, because the former are absorbed in early stages of development. The occurrence of food substance outside of the embryo in Morning-glory and Corn should be used to make students seek for its equivalent in Beans and Horse-chestnut, and thus to work out the differences between "albuminous" and "ex-albuminous" seeds.

Of the greatest morphological value is the Exercise 7 (*b*), which is one of the best I have ever tried for inculcating a

correct idea of morphology, the more especially when it is later supplemented by a series to show the germinated stages of the same seeds. But it must be remembered that generalization is not natural or easy to beginners, and they will need some guidance in the method of constructing the diagram. In drawing these diagrams an effort should

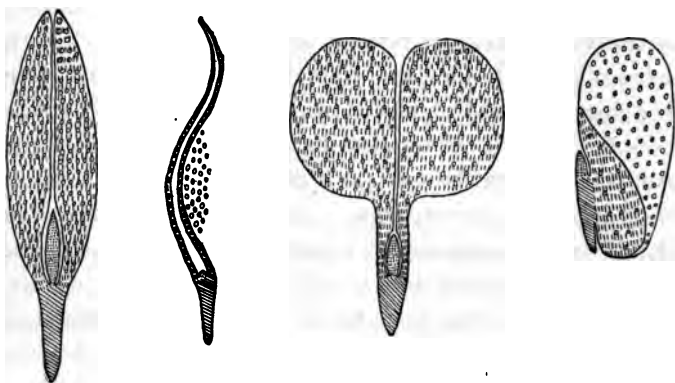

FIG. 18. — Diagrammatic figures of embryos of Lima Bean, Morning-glory, Horse-chestnut, and Corn, shaded to show morphologically equivalent parts. Diagonal lines = hypocotyl; vertical lines = cotyledons; dots = plumule; circles = food substance.

be made to represent only the principal corresponding parts placed in corresponding positions. The diagrams should look somewhat as illustrated in Fig. 18, except that the equivalent parts can be brought out much better by colored pencils than by the black and white lines here made necessary by the method of engraving. The food substance may be represented by small circles of blue, or of some other color. In 7 (a) they should not run to details of little importance, and resemblances should be emphasized as well as differences.

About this time a tendency will manifest itself to turn the laboratory exercise into a drawing lesson; this must be firmly met by making it plain that the laboratory time is for observation and the essentials of recording, and that all niceties of shading, etc., must be added in outside time, though rapid workers may naturally be permitted some liberty in this respect.

No new terms are needed except *endosperm* and *albumen*, the latter only in connection with the compounds "*albuminous*" and "*ex-albuminous*." It is best not to give at all any terms of very limited application, such as "*scutellum*."

While the subject of the structure of the seed is fresh in mind, it will be well for the students to read the very fine chapter on this subject in either of Dr. GRAY'S text-books. Many additional exercises on seeds are outlined in the various text-books, and if other materials for the next following exercises are wanting, or some students manifest a special interest in the subject, these may well be introduced. But for most students it is more profitable to pass on to other subjects than to spend additional time upon this.

Here, as in all subjects, the teacher should supplement and extend the very limited, even though thorough, knowledge derived from laboratory study, by a comprehensive account, in demonstration or lecture, of the topic from various points of view. He should exhibit the range of seeds in form, size, color, and comparative development of embryo and food substance, but should postpone the explanation of the meaning of the various appendages until the next topic (Ecology of seeds) is studied. Of course the subject will be illustrated as thoroughly as possible by diagrams and museum specimens. A general account should also be given, in connection with

an explanation of raphe and micropyle, of the development of the seed from the ovule.

**Physiology.** — Here also comes properly the study of the first of the physiological topics, — the kinds of plant food; for these are better shown in seeds than anywhere else. The principal plant foods should be exhibited in good permanent specimens, — starch, grape sugar, cane sugar, cellulose (from ivory nuts or date seeds), oil (*e.g.* cotton-seed oil), and proteins, all of which can be bought at low price from chemical supply companies. Some of these foods (*e.g.* the sugars) are rare in seeds, but this is a good opportunity to consider all the principal plant foods together. The appearance and different uses of these substances, and their microscopical appearance (in diagrams at least), should be made thoroughly known, with a mention of the principal tests or recognition marks; and it should be made plain that they occur also in other storage parts of plants, in tubers, bulbs, fleshy roots, buds, and elsewhere. The iodine test for starch should be experimentally demonstrated on both specimen starch and some seeds (Experiment 1). A good iodine solution for this purpose is described on a later page (p. 296). I doubt whether it is profitable in time and effort for the students to apply the tests for other substances, but if the teacher differs from me here, he will find very good simple directions for the use of these tests in BERGEN'S *Essentials of Botany*, or in OSTERHOUT'S *Experiments with Plants*. Then the students should be led to recall that these substances, which constitute plant food, are the principal food of animals also; and the great economic importance of seeds, as forming the principal food of mankind and of many domestic animals, should receive consideration and emphasis.



In connection with the physiological experiments the teacher should consult the general discussion of this subject in an earlier chapter (page 80). I have found it most advantageous to require the students to write up each experiment as part of a brief exposition of the physiological subject to which it belongs, the other data therefor being given in demonstration or lecture. Hence, in the outlines, a skeleton or synopsis is given (*e.g.* as under Section 8), indicating by leading words the principal matters concerned, and incorporating the experiment in its suitable place and connection; and this synopsis serves as a guide to the student in writing his account of the subject. The teacher should be especially careful, in the records of the experiments, to insist that a clear distinction be made between the four logically-distinct features, the object of the experiment, the description of the method and appliances used (with illustration where contributory to clearness), the actual results obtained, and the conclusions. A clear differentiation between the third and fourth in particular is indispensable to good scientific exposition.

Considerable simple physiological experimentation upon the growth of seeds in relation to temperature, light, moisture, and oxygen, is possible, and described especially in BERGEN'S text-books. Most of these facts thus proved, however, are not specially characteristic of seeds, but apply to other stages of growth as well, and some of them are noted later in these outlines. In general, as regards physiological experiments, I believe it is much better to concentrate upon a few, dealing with those topics which illuminate the most fundamental matters, and to do them thoroughly well, rather than to do more, of lesser worth, and less perfectly.

### III. The Ecology of Seeds

9. The seed is the only stage in which most plants can be spread from their place of origin. Since seeds have no power of independent locomotion, they secure this dissemination only by aid of other natural agencies which do move. Many adaptive features, such as special appendages, peculiarities of form, etc., exist, enabling the seeds thus to be carried.

What different moving agencies in nature can you think of, which could carry suitably-constructed seeds?

10. Study the ten seeds supplied to you. In each case work out and record:—
- (1) To what moving agency are the appendages probably adapted?
  - (2) What accessory features of shape, weight, etc., are found in the seed itself?
  - (3) What part produces the appendages?
11. Write a concise essay (of not more than 300 words) preceded by a tabular outline of contents, upon the principal facts deduced from your laboratory work, from the lectures, and from your reading, as to the structure, morphology, economics, and ecology of seeds.

**Materials.** — These, of course, must chiefly be collected beforehand in the summer, though some should be brought in by the students while others are drawn from gardens or the museum collection. They should include all of the principal types of dissemination methods. Especially good kinds are those of Maple, Milkweed, Clematis, Agrimony, Spruce or Pine, Desmodium, Ptelea, Elm, Xanthium, Burdock, Bidens, Dandelion, Tecoma or Catalpa, Erodium, Witch Hazel, Violet, Galium, Castor Bean, *Geranium maculatum*. It is desirable to have, as in this list, some seeds and some "fruits." Certain kinds, *e.g.* Violets, Witch Hazel, Castor Beans, will hurl out their seeds with considerable disturbance, and to good educational effect, if the fruits are brought when nearly ripe into the dry air of the laboratory.

**Suggestions on Teaching.** — This work is designed for further training in observation and comparison (morphology), but especially for an introduction to ecology (*i.e.* adaptation to conditions of the external world).

In ecology, if the study must be made perforce in the laboratory and not out of doors, the students can do little better than guess at the use of the different appendages. They can, however, be much helped if led to recall certain facts, already known by observation, as to the carrying of maple, willow, and other seeds and fruits by wind, and the sticking of seeds to their clothes in their walks through autumn fields, as well as by some simple experiments, suggested by the teacher, upon the different seeds in the laboratory. The use of berries and other pulpy fruits must be suggested by the teacher, since it could hardly be imagined from laboratory study. This work will involve much theorizing, but this is of the greatest biological value if kept checked by rigid obser-

vation or other confirmation, though it can bring intellectual injury if allowed to degenerate into untested guessing. In case confirmation from outdoor observation is impracticable, the correctness of their theories will need to be decided by the teacher, who should be thoroughly informed upon the subject; but it should be made plain that the teacher's knowledge is not better than their own observation, but only a substitute enforced by circumstances. In Exercise 9 the students will think of *wind*, *animals*, and probably *water currents*, to which, after hints from the teacher, they will add *projection by spring apparatus*; and this list includes all of importance.

In the drawings by the students the important appendages should be clearly brought out; for example, in the Burdock, half of the students will not of themselves represent the hooked tips, though these are plainly visible; in such cases the students should individually be told they have missed something important, and left to seek until they have found and correctly represented it.

Although the subject of the morphological origin of the various appendages is of exceptional interest, the subject is rather too special, and the available data too scant, to permit the students to work it out for themselves, except in the more obvious cases. But it should be completed in demonstration, the teacher supplying information as to the structure of flower and fruit. The student will learn therefrom the great ecological principles that structures identical ecologically may have very different origins morphologically and *vice versa*, and that function has an apparent great power of molding structures.

A fully-illustrated account of this very important subject

of seed dissemination, one of the most interesting of all botanical topics to most people, should be given in a demonstration or lecture. Books relating to it may be found cited in Chapter VIII. Other apparent adaptations in seeds may also be illustrated, such as their protection against animals while unripe, their modes of absorbing water, and the means whereby some kinds secure their own planting.

It is hardly necessary to point out that this subject is an extremely profitable one for field study, especially as its natural place in the course brings it into the very best time of the year for the purpose.

After the completion of this study of seeds, an essay on the subject is desirable, upon the principle discussed in Chapter V (p. 105). After the students have done their best on this essay, it will be well to read them one written by the teacher as a model. In illustration of this matter I venture to add here the one I have read for this purpose to my own students: —

## SEEDS

General Function.

Structure, — Coats, Embryo, Food substance.

Economics.

Dissemination.

The seed is a separable portion of specialized plant substance securing reproduction and dissemination. Under a variety of forms, sizes, colors, and special structures, seeds have in common the coats, embryo, and food substance. The coats, one or two, are protective, and the outer usually shows the scar of attachment to the pod (hilum), a pit by which the fertilizing pollen tube entered (micropyle), and an attached part of the ovule stalk (raphe). Within the coat is

the embryo, which is the young plant; it consists of stem (hypocotyl), on which are placed laterally one or two leaves (cotyledons), and which merges upwards into the bud (plumule). The food substance may be stored in the cotyledons, making them thick, or around them, or in both ways. This food substance not only serves to nourish the young plants, but is utilized for food by man, as well as by many other animals.

Transportation is as essential to plants as to animals, and since the adults cannot move, the seed is generally utilized as the transportation stage, and on it are developed appendages which cause it to be carried by some of the natural moving agencies. These appendages may be outgrowths of the seed coat, or of ovary, style, or calyx, which are retained. They may consist of wings or plumes utilizing the wind: hooks attaching them to the fur of animals: pulp, surrounding indigestible coatings, eaten by animals: and other peculiarities of form or structure; or such peculiarities may be absent altogether, in which case the smooth, round seeds are often projected by the springing of elastic tissues.

Such essays are equally valuable under the various subjects to follow, though for brevity's sake all mention of them is henceforth omitted from the outlines. I think they are most in place at the close of subjects VI, VIII, XIII, XVII, and each of the subjects of Part II.

#### **IV. The Germination of Seeds and Growth of Embryos to Seedlings**

12. Study the germinating String Beans, and, in comparison with your records of the ungerminated seed, observe: —

- (1) Whether all seeds have developed at the same rate. If not, can you see any reason for the differences?
- (2) Where has the coat been burst and by what force, do you think?
- (3) What change has occurred in the food substance?
- (4) What changes of shape, size, and color have occurred in the parts originally in the seed?
- (5) Have any new parts appeared?
- (6) Does hypocotyl, root, or epicotyl develop most rapidly? Can you imagine a reason therefor.
- (7) What part appears first above ground?
- (8) What are the relative positions of main and side roots?

*Answer in words or by drawings, whichever is most expressive.*

13. Study in the same manner the other germinating seeds, viz. (a) the Horse Bean, (b) the Morning-glory, (c) the Corn.
14. In young seedlings, what positions do the growing hypocotyl, root, and plumule take relatively to:
  - (a) The position of the seed as planted?
  - (b) Any feature of the environment?

*Illustrate by a series of outline drawings of three or four Corn seedlings.*

## 15. A study of the digestion of plant food in germination.

The change of appearance of the food in seeds during germination; its disappearance from the seed: mode of its transformation to a soluble form, — that is, digestion, — with an experimental test of the digestion of starch by the enzyme diastase (Experiment 2); general nature of the digestion of other foods in the seed, and of others elsewhere in the plant; relations of plant digestion to animal digestion.

*Write a synoptical account of this subject precisely as for No. 8 earlier.*

**Materials.** — For the profitable study of this and the two following exercises, plants alive and growing are indispensable. Happily they are obtainable under almost all conditions. The seeds can be germinated and grown to sturdy seedlings in any well-lighted place where the day temperature approximates 70° F. and does not fall much at night, as, *e.g.*, in a greenhouse or Wardian case, though a schoolroom unheated at night will not serve in cold weather. The plants must not be watered with chilled water, but from a vessel kept standing long enough for the water to take the temperature of the room. They may be grown in any wooden boxes, but here, as elsewhere in scientific studies, it is best to have neat boxes, made and preserved especially for this use. After trial of many forms I have found the best satisfaction in the germination box pictured in the accompanying figure (Fig. 19). It is of thin wood, 8×6×5 (deep) inches, painted (dark green) for preservation and has one glass side held in a groove,



sloping at about  $20^{\circ}$  from the vertical. The advantage of the sloping glass is found in the clearness with which the roots exhibit their characters as they press against it. Made in quantities at a box factory, they cost 10 to 12 cents each complete, and can be used for many years. The best material in which to grow the seeds is the clean, porous, water-

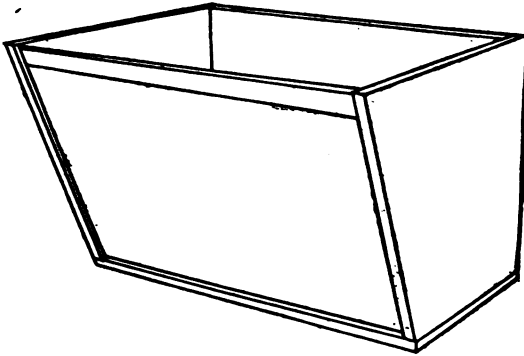

FIG. 19. — Germination Box, with sloping glass front;  $\times \frac{1}{4}$ .

holding sphagnum moss (preferably chopped fine), which is so superior to all other materials that it is worth while to take much trouble to obtain it. It may be bought at low price from all dealers in gardeners' supplies, and can be used year after year indefinitely if occasionally steamed to kill the molds. Next best is sawdust, in which it is not so easy to keep seedlings healthy; pure pine sawdust is said to be best. Soil or sand is not good, since it is too difficult to remove the seedlings without injury. A box to each student, used until the growth is completed, and returned to the greenhouse between periods of observation, is the ideal arrangement, though fewer will suffice. The seeds do not germinate at the same rate, and need to be planted at different times in order

to bring them along together; thus, under the best conditions the Horse Bean requires about ten days (Lima Bean is difficult to germinate in autumn), String Bean and Corn eight days, and Morning-glory six days, to bring them into the seedling stage, but this time, of course, will vary with the surrounding conditions.

**Suggestions on Teaching.** — This work is intended to continue training in observation and comparison, and to give a knowledge of the morphological and ecological facts in the unfolding of the embryo to the seedling.

The students should not fail to notice that the root, the root hairs, the turning green of parts exposed to light, the axillary buds of the cotyledons in the Horse Bean, and the partial disappearance of food substance, are new features. They should especially see that it is the elongation of the hypocotyl which raises the cotyledons in Lima Bean and Morning-glory, while that structure does not increase at all in length in the Horse Bean and Corn. The root is, of course, a new structure developed from the lower end of the hypocotyl, and its beginning is usually marked by a slight constriction or by the first side roots. Students will tend to call the main root hypocotyl, and to call only the side branches "roots," which must be corrected. The structure of the root, including the tips and root hairs, is very plainly seen through the glass, especially by use of a lens. Full labeling of the drawings, in order to bring out the homologous parts, is very important.

In ecology they will notice that the root grows faster than the plumule (of course because absorption of moisture is a first need), and that the size of seed, the position in which it is planted, and the amount of moisture available, all have

something to do with the different rates of development of the same kinds of seeds; and to these influences some students will probably add another, viz. a real difference in their living matter, which is important. We have here an introduction to facts of individual variation, so important in evolution. They will, of course, readily notice in Exercise 14 that the position taken by hypocotyl and plumule (or rather epicotyl), in growth, bears no relation whatsoever to the position of the seed, but that, regardless of this, all hypocotyls bearing the roots grow down, and all plumules grow up. With the aid of some suggestion from the teacher, they can readily be led to see the ecological advantage of this, in that it takes these parts into the positions advantageous for their respective functions. From specimens of each of the kinds in the boxes the young plumules should be pinched off, the results to be noted the next week.

It would be of interest also in this connection to study the germination of Horse-chestnut, but practically this seed is very difficult to germinate.

**Physiology.** — In connection with germination comes naturally an important physiological topic, that of digestion. From their own observation the students will learn the facts as to the softening and change of color of the seeds in germination; and the familiar phenomena in sprouting potatoes should be recalled. They will readily understand that the insoluble food materials of the seeds, viz. starch, oils, cellulose, and proteins, cannot be moved through the tissues in a solid form, but must be made soluble. This process is well known in animal physiology where it is called digestion, a name which is equally applicable to plants. It is known to the students that the saliva effects the digestion of starch,

a fact which they can easily demonstrate for themselves by placing some saliva in water in a test tube and then proceeding to add starch as described below. The teacher should now explain that diastase, the same as is contained in saliva, occurs abundantly in germinating seeds, from some of which (*e.g.* barley) it can with some trouble be obtained, though it can also be bought at low price from any dealer in chemical supplies. A very effective experimental demonstration of digestion of starch by this diastase can be made as follows: Dissolve 1 gram of diastase in 100 cc. of water (which takes but a few minutes); prepare a thin starch paste by placing 1 gram of starch in 100 cc. of water in a conical flask and bringing to a boil (a starch paste is preferable to powdered starch simply because the diastase can get at it more quickly); pour a little of the paste, when cooled, into a test tube and apply a few drops of iodine solution (to show the perfect starch reaction), and also likewise test a little of the diastase solution (to prove it has no starch). Then add 25 cc. of the starch paste to the diastase, shake quickly, pour a little of the mixture into a test tube, and add iodine (to show that the mixture gives the starch reaction). Stand the diastase in a warm place (preferably about  $28^{\circ}$ - $30^{\circ}$  C.), and at intervals of about 5 minutes pour a little into a test tube and add iodine. If the experiment has been well performed, the third or fourth test will show no starch, proving that it has been digested within fifteen or twenty minutes, and a smaller proportion of starch will disappear more quickly. If one wishes, he can now add the test for grape sugar, proving that the starch has been converted into that substance, though this, I think, is rather elaborate for elementary work.

**V. The Development of Seedlings into Adult Plants.**

16. Study, in comparison with your records of the earlier stages, the seedling of the String Bean.

- (1) Into what has each part of the original embryo finally developed?
- (2) How are the new leaves placed relatively to the cotyledons and to one another?
- (3) How do the later leaves differ from the earlier?
- (4) How many buds are there, and where are they?
- (5) Where does hypocotyl end and root begin?
- (6) Is there any regularity in the arrangement of new roots as there is of new leaves?

*Answer these questions, and others henceforth, by the methods you consider most expressive.*

17. After the same manner study the Horse Bean seedling, and also observe:—

- (1) What is the position of the cotyledons as compared with the String Bean, and what difference in the development of the hypocotyl is thereby involved?
- (2) What do you imagine is the reason why these cotyledons are not raised to the light?

18. After the same manner study the Morning-glory seedling.

Why do you think the plumule develops so late, and with what peculiarity of the cotyledons is this correlated?

19. After the same manner study the Corn seedling.

From what parts do the upper roots come? Have you ever noticed anything similar in adult Corn plants?

20. From your observations deduce and express the morphological nature of hypocotyl, cotyledon, and plumule, in terms of root stem and leaf.

21. Construct a series of four generalized diagrams of the seedlings studied, upon the same plan, in the same colors, and on the same page as the diagrams of the embryos under Exercise 7, expressing the comparative morphology of the four seedlings in comparison with one another and with the seeds from which they grew, using, however, the Horse Bean in place of the Horsechestnut.

22. A study of the nature of the green color (chlorophyl) of plants.

The development of chlorophyl in seedlings; extent of its presence in plants generally; mode of occurrence in plants; its experimental extraction and examination, and the appearance of the blanched leaf (Experiment 3). Its properties;

its destruction in light, and the relation thereof to autumn coloration.

**Materials.** — These would consist naturally of seedlings remaining in the germination boxes earlier used, but in fact seedlings will not grow enough farther for the present work in one week. They should have reached a state where the third or fourth leaves show. Hence it will be necessary either to arrange for a gap of a week or two at this point, or else to plant a set of the same seeds three weeks earlier than those needed for the preceding work.

**Suggestions on Teaching.** — This work is valuable in part for further training in observation, but chiefly for the knowledge it gives of the morphological features of the developing plant. It is, however, one of the exercises which can best be spared, because a part of its results can be brought out in the preceding and succeeding exercises.

In observation, the students should not fail to see and record, in addition to the more obvious features, the axillary buds of the cotyledons in some kinds of Beans: the stipules of the String Bean (united in pairs at the first leaves): the arrangement of the earlier roots in four ranks (answering to their origin from a system of four fibrovascular bundles): the aërial roots of the corn appearing above the cotyledon: and the fact that leaf veins taper from base to tip and are all united with one another. They should also find the position of the terminal bud in the Horse Bean. The study of the leaf arrangement of the seedlings gives a good first introduction to phyllotaxy.

In ecology, the students may be led to work out for themselves certain probabilities; that the failure of the cotyledons

to come above ground in two of the seedlings is probably due to the fact that the cotyledons are too thick to be useful later as green leaves, though in most cases cotyledons are thus used; that the small supply of nourishment in the Morning-glory explains the late appearance of the plumule, since the cotyledons must first make food enough to form it; and that the peculiar forms of the first leaves of most seedlings may be due to their forming a transition from cotyledons to ordinary leaves.

**Physiology.** — The very fundamental subject of food-making, or photosynthesis, comes naturally at this point, and in any case, on the ground of logical sequence of physiological processes, belongs early among the physiological topics. It can be approached very advantageously through a study of chlorophyll and some of the extremely interesting phenomena connected therewith.

Here, as always, the teacher should lead the students up to the point where an experiment becomes a logical necessity. He should direct their observation to the fact that the chlorophyll appeared in the seedlings as these came up to the light, and then he should lead them to recall its distribution in plants as a whole, — that is, the vast majority, and all large plants of independent life, possess it, while only parasites (or saprophytes) are without it. Its occurrence in the plant in grains should be shown, at least from illustrations, and the question then is natural whether it can be extracted. For the experimental test of this, select nearly mature, thin, clear-green leaves, *e.g.* those of String Bean, Primrose, Castor Bean, Young Oats; place these (flat or rolled, not crumpled) in a loosely stoppered conical flask or large test tube, and cover them with alcohol (denatured or other); then lower the test



tube into a beaker of water which has been brought to boiling, first extinguishing the flame for safety. A suitable arrangement for the purpose, which should be preserved ready for use year after year, is shown by Fig. 20. The alcohol will then boil almost immediately, and the chlorophyll will come out before the eyes as a beautiful rich clear green solution. Its optical properties, including its exhibition of remarkable red lights (fluorescence) in certain positions, especially when sunlight is focused upon it by a lens, may then be studied at leisure. The chlorophyll should not be extracted in direct sunlight, which disintegrates it. It can be extracted equally well, though much more slowly, by simply standing the dish in a warm place, as on a radiator, for some hours or over night. Some **thick leaves** do not release the chlorophyll readily unless they have first been boiled a **minute or two** in water, and this facilitates its exit in most **though with very thin ones it comes quickly enough**

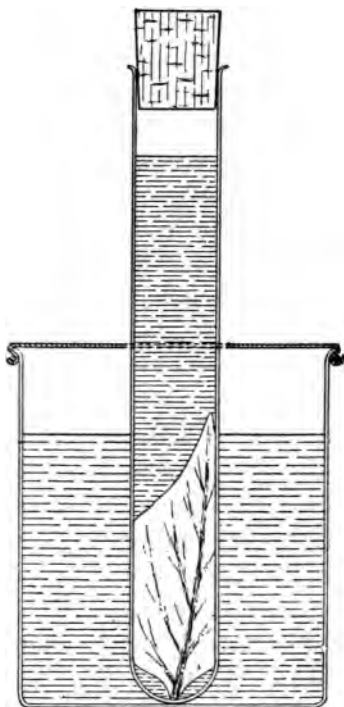

FIG. 20.— Efficient arrangement for the extraction of Chlorophyll in demonstration;  $\times \frac{1}{2}$ .

The support for the test tube at top of the beaker is of wire.

without this. Some leaves of a marked yellowish cast, *e.g.* some *Pelargoniums*, give a yellowish green solution, and should be avoided. If perfectly blanched leaves are desired, a larger quantity of alcohol, or a fresh supply, may be needed, and they blanch rather better by the long treatment on a radiator. To remove the brittleness of the leaves, and thus prevent breakage in handling, it is only necessary to replace the alcohol for a minute by water.

The destruction of chlorophyl by light should next be studied, as an introduction to a consideration of the very important matter of autumn coloration, which ought to be prominent at this time. This destruction is well shown by dividing the solution between two test tubes, which are then stoppered and placed side by side and treated just alike in every way, except that one is exposed to direct bright sunlight and the other is darkened (for a control); the green begins to change in a few minutes, and in an hour or two becomes yellow, which in time fades away entirely. This is exactly what happens in autumn leaves. The yellow (*xanthophyl*) is a color associated there with chlorophyl, but disguised by it, but it is far less destructible by light. It can be extracted by alcohol from leaves which have turned bright yellow in autumn (using much leaf to little alcohol), and it gives a solution very like that remaining after the destruction of the chlorophyl in the test tube. The red color (*erythrophyl*) in autumn leaves is of wholly different nature; it is soluble in water, and can easily be extracted from deep red autumn leaves in a beautiful clear red solution, by the methods used for the chlorophyl, but employing water instead of alcohol. It can also be extracted easily from some red-leaved foliage plants, which are then shown to be green. ¶ the three

chief plant colors and their relation to the great phenomenon of autumn coloration, is of such interest and attractiveness that the teacher will be wise to make much of it.

## VI. The Mature Plant

23. Study the mature Bean plant in comparison with your records of the earlier stages, and determine :—
- (1) Has the mature plant any parts not present in the seedlings?
  - (2) In what places, relatively to leaf and stem, do they stand? Remove the plant from the pot, wash away the soil, and observe the external structure and arrangement of the new roots.
24. In comparison with the Bean, observe the structure of the Coleus and Chrysanthemum. Are the three plants alike or different in regard to the following features :—
- (1) Is there any constant relationship of position between leaves and nodes? Between buds and leaves? Between flowers and buds?
  - (2) Is there always an alternation of nodes and internodes? Are the latter of any constant length? Of any constant shape in cross section?
  - (3) Is there any way to distinguish between a

simple leaf and a leaflet of a compound leaf?

- (4) Is there any regularity in the arrangement of leaves on the stem?

*Invent simple and logical plans for showing the leaf arrangement in these three plants.*

25. Make a study of other plants exhibiting marked deviations from the common and typical structure exhibited by the three already studied.

In what features, of those mentioned under 1-4 preceding, is each plant different, and have you any idea of the possible connection of the differences with the habits of the plant?

26. A study of the action of light upon tissues containing chlorophyl.

The distribution of chlorophyl in the individual plant, and its relation to the abundance of light: the resulting implication as to a connection between the meaning of chlorophyl in the plant's life and the action of light. Should not, then, some difference exist between chlorophyllous tissues kept in light and dark respectively? Obviously this can be tested by experiment (Experiment 4). Fate of the starch in darkness: increase of weight accompanying starch formation: cases in which starch is not formed, but other substances: the basis made in leaves in light.

**Materials.** — Bush Beans are very easily grown, one in a pot, and in a greenhouse may be brought into flower and fruit in about six weeks. They are much better than Lima and Horse Beans, which grow so large as to become unmanageable. They are self-pollinating, but the process may be made more certain by jarring the pots sharply on the table when the flowers are open. Of course other plants may be used, but the advantage of following some one kind of plant through its entire cycle is very great, and the Bean shows a particularly large number of important features. One plant will do for several students, though the ideal is one to a student. As to the other plants needed, those for direct comparison should show a typical opposite phyllotaxy and a typical spiral on the  $\frac{2}{3}$  system, for which *Coleus* and *Chrysanthemum*, respectively, are particularly good. As to the other materials, for Exercise 25, these are intended to include representations of leaf and stem, which, while showing extreme modifications of form and size, still retain their typical functions, or at least have no function other than foliage. For this, living plants, which must usually be greenhouse plants, are much the best, though herbarium and museum specimens are also very useful. They should include plants (*a*) with very long internodes (as in climbers, *e.g.* *Aristolochia* or Dutchman's Pipe), and with very short ones (as in rosette plants, *e.g.* Houseleeks and Primroses); (*b*) with flat stems and visible leaves (*e.g.* *Muehlenbeckia*), or almost invisible leaves (*e.g.* the florist's *Smilax*); (*c*) with flattened petioles or phyllodes, as in *Acacia* (especially *A. melanoxylon*, showing all transitions from phyllodes to leaves); (*d*) with leaves of extreme forms, or those various ways, or those in which the stipules large (*e.g.* *Lathyrus Aphaca*), or unifolio-

late or connate-perfoliate leaves; while finally *Colletia*, *Ruscus*, *Ilex*, and some other odd forms found in most green-houses are also very useful.

**Suggestions on Teaching.** — This work is designed to give knowledge of the composition of a typical adult plant, including especially the principal systems of leaf arrangement (or phyllotaxy), and the plasticity of the parts in size and form while retaining their functions and mutual relationships of position.

In the adult plant, if it be a Bean, the students, as a matter of observation, should not miss the pulvinus of the leaves, nor the stipels, nor the nodules on the roots, nor the calyx and bracts on the fruit; and of course they will determine that the flowers stand in the positions of buds. Then by comparison with the other plants they can be led to see that under marked difference of appearance certain features are common to them all, viz. the stem is made up of nodes, places where the leaves stand in regular order, separated by leafless internodes; buds appear in leaf axils or at the tip of the stems; and roots are ordinarily single irregularly branching structures. Their understanding of the matters will be greatly aided if the teacher will give an illustrated account of the way new leaves and stems develop from buds; and, of course, he will avoid the idea of the phytomer, which is quite erroneous, as earlier explained (p. 232). It is not desirable to go very far into the matter of phyllotaxy, but the students should be led to understand the opposite and spiral systems, and the mode of expressing the latter in fractions; and their attention should be called to the obvious regularity of arrangement in rosettes, cones, etc. They should be aided in exhibiting the different systems, which a

marks, indicating the places of the leaves, arranged on circles or spirals, as if the plant were viewed from above.

The systems of phyllotaxy described in the books and expressed by fractions do certainly exist, and may be traced; but the teacher should carefully avoid leading the pupils to imagine they find exact fractions which theoretically ought to be present, when in fact they are not; for the systems are very easily thrown out by twisting of the stem in growth, or by injuries. Of course, the phyllotaxy has very little to do with the ultimate position of the blade; it holds true only for the origin of the leaves in the bud, and its significance is still obscure.

The work with the special plants is very important, since it serves to show how widely the parts of the plant may vary in form and yet retain all their old mutual relations of position. This work can be made of very great interest to the students, since it exercises some of the same qualities which find pleasure in the solution of puzzles; while it certainly is of great scientific value as typical work in morphology. A good conception to bring before the students after this study is this, — to lead them to visualize or imagine every part of the plant as well-nigh indefinitely elastic or plastic, as if the plant were made of the most elastic rubber, so that any part may be drawn out or reduced indefinitely and altered greatly in shape, while all parts still retain, unchanged, their old relationships to one another. The readiness with which the stem assumes the leaf function shows how closely related these are, and illustrates the table of morphological independence given **page 234, in this book.** As regards the explanation form, in connection with the different students can do little of themselves,

though it is well to have them ask the questions. Then the teacher, in the demonstrations, should supply the account of the correlation between habits and form.

**Physiology.** — This is the appropriate place for a beginning of the study of the most fundamental of the physiological processes of the plant, food making or photosynthesis (formerly called carbon assimilation). As introductory to the experiment, it is particularly important that the students be led to observe or recall for themselves the fact that chlorophyl, in the plants they are now studying, is confined to lighted parts, and, moreover, is condensed towards the best lighted surfaces (the upper surfaces of most leaves are a denser green than the under), while, furthermore, most plants turn their green parts towards the light. This all implies a close connection between the work of chlorophyl and the action of light, which in turn suggests that some difference ought to develop between green tissues kept respectively in and away from light. This leads logically to Experiment 4, which is performed thus: Select a thin-leaved plant (*e.g.* Horseshoe Geranium, Fuchsia, German Ivy, String Bean), and keep it over a day in a warm dark place (to empty its leaves of starch). Then darken a part of a nearly mature leaf by a normal light screen, *viz.* one which will cause areas to contrast in exposure to light and dark, while otherwise treated alike and in such manner that the under surfaces are left free for the entrance and exit of gases. Stand the plant in a moderately warm place in bright diffused light (not strong sunlight), for two or three hours (a shorter time in summer, longer in winter). Then remove the leaf, boil it for a minute in water (to swell the starch and make this more distinctly visible), blanch it of chlorophyl by one of the methods earlier



used, remove its brittleness by use of water, place it in a white dish (ordinary saucer or plate), and cover it with iodine solution. Then the areas containing starch, which will be those exposed to the light, will stand out in blue against the white of the starchless darkened areas.

This experiment is so striking and important that it should always be included in every botanical course. It can be varied in numerous ways.

The best normal light screen known to me is a piece of tin foil cut with a pattern and then attached to a glass, which is pressed against the upper surface of the leaf, tin foil down; the lower side of the leaf is darkened by a small box, black



FIG. 21. — Simple Normal Light Screen;  $\times \frac{1}{2}$ .

inside, and provided with a network of threads to hold the leaf against the tin foil, while air is admitted through small holes guarded inside by flaps to prevent entrance of light. Screen and box may conveniently be joined into one piece by a spring wire which clamps them over the leaf. Such a screen, illustrated in Fig. 21, is obtainable at moderate cost among my normal apparatus (mentioned on page 135), while a very much larger form adapted to take an entire leaf, for more striking results, is obtainable in the same apparatus. The use of two corks, matching on the two sides of the

leaf, as illustrated in many books, is wholly wrong, for the exclusion of carbon dioxide by the cork will result in absence of starch whether light is present or absent, and this is true of any method which cuts off the carbon dioxide supply. The plant must not be allowed to become heated much above 22° C., for then the starch is removed as fast as formed, and no good result is yielded by the iodine test. The iodine solution is made thus: Dissolve 5 grams of potassium iodide in 50 cc. of water, add 1 gram of solid iodine, and when all is dissolved, pour into 1 liter of water; the mixture, tightly stoppered, is a stock supply. This is an economical solution, and can be made stronger in both chemicals for quicker results. Or, one can use ordinary tincture of iodine diluted with about 20 times its bulk of water. Very sharp, clear transitions between starch-holding and starch-free areas, can be obtained with tin-foil screens. Indeed, so sensitively does starch formation respond to light that one can use a photographic negative to print in the leaf a positive in starch which may be "developed" by iodine. For satisfactory results with this striking experiment, the leaf must be held flat against the negative (which should have as much contrast as possible), for which purpose the larger light screen above mentioned is especially effective, though one can also use a small negative, or even film, with the smaller light screen. A very thorough study, showing the best plants for this experiment, the best length of time to keep each in darkness beforehand and in light with the screens, with other suggestions and precautions, is given by SOPHIA ECKERSON in the *Botanical Gazette*, 48, 1909, 224.

The blue color of the iodine starch soon fades from the leaves, but they can be preserved indefinitely in fifty per cent alcohol,

and the color may be restored at any time, with all its first distinctness, by new applications of iodine. Moreover the color can be made to fade very rapidly, thus preparing the leaves for a second demonstration, by placing them for a time in strong alcohol. In continuation of the experiment, the teacher should then explain that the starch is removed from the leaves into the stems in darkness (and in light also, but less rapidly than it is formed), and that leaves increase in weight in light, and lessen in weight in darkness. He may also, to advantage, explain how this latter matter is conclusively and beautifully proven by methods described in the books devoted especially to physiological experiment. He should also state the fact that in some leaves it is not starch, but grape sugar (and rarely cane sugar), which is formed in light, while there is good reason to believe that grape sugar is first formed in all leaves, being converted at once into starch in the majority. Grape sugar, therefore, is the basal substance formed under action of light in green tissues. Now it is from this grape sugar that all the other food substances of the plant are formed, mostly by comparatively simple changes, so that the grape sugar made under action of light in leaves is the basal plant food. And, since animals take all of their food, directly or indirectly, from plants, it is the basal food for animals also.

## VII. The Morphology and Ecology of Winter Buds

27. Study the Horse-chestnut twigs, particularly the buds. Recall your knowledge of how the buds of this tree develop in the spring.

(1) What different kinds of markings does the

twig show, and what do you suppose is the meaning of each?

- (2) What positions have the buds in relation to any other structures?
  - (3) What sizes and shapes have the buds, and can you imagine a reason for the differences?
  - (4) What colors have the buds, and do you see any reason therefor?
  - (5) What is the exact structure of the buds, and the morphological nature and probable function of each part?
  - (6) What features of the buds appear to be adaptive to their protection over winter?
  - (7) Is there any evidence to show the age of the twig?
28. Study similarly the Tulip-tree twig.
29. Study also the other twigs supplied.
- Outside of the laboratory, examine as large a series of twigs and buds as possible.
30. A study of the source of the materials used in food making.

Chemical composition of the basal substance formed in light: suggestions therefrom as to the probable source of the hydrogen and oxygen, and the known facts; possibilities as to the source of the carbon; evidence that it is not derived from the soil. Dn

it then come from the atmosphere? This can be tested by experiment (Experiment 5). The formation of food (synthesis) under action of light (photosynthesis).

**Materials.** — These should be obtainable everywhere. The Horse-chestnut is best, but any others with very large terminal buds, especially if containing a flower cluster (*e.g.* Walnut, Hickory), are nearly as good. The bud scales of the Tulip tree are modified stipules, and afford an exceptionally good morphological problem which the student can have the pleasure of solving for himself; the same feature occurs in the Magnolia, and also in Beech, though less plainly. Other very useful buds are Lilac and Norway Maple. Some unprotected buds of greenhouse plants are very desirable for comparison.

**Suggestions on Teaching.** — This is one of the most satisfactory of all botanical exercises. The objects are large and fairly definite, and the student has data enough to enable him to discover for himself the meaning of nearly every feature of morphology and adaptation, for training in both of which it is particularly favorable. It is important to recall to the students the general habit and mode of growth of the Horse-chestnut, helping by suggestions when memory fails, and leading one member of the class to aid another, until it has been well worked out. Of course the significance of winter buds, as existent solely because the winter stops growth, will be made plain.

The features which the students should work out fully for themselves are the lenticels (whose function as openings, ~~tion~~ and exit of air, will need to be explained

to them, after they have tried to think of a use); the leaf scars, with fibrovascular bundles showing in number answering to the number of the leaflets; rings of scars of the bud scales; and the scars of fallen flower clusters. They should work out the age of the twig from the transitions between different colors of bark, and from the old sets of bud-scale scars, and should determine that the buds are both axillary and terminal. They should notice that the largest of the buds are nearest the tips, and should conclude that these are probably the ones which will develop, being in the places where light and space are most abundant, while the smaller and more remote remain latent and serve as a reserve. The color of the buds is simply that of the bark, which, the teacher can explain after the students have considered the matter, is simply the composition color of corky substance and has no known use. The structure and morphology of the bud parts they should now be able to work out and represent accurately and completely, including the place of origin of the wool; and they will probably explain correctly the function of the different parts peculiar to these buds, — the outer scales, sometimes with additional resin, etc., as a waterproofing adaptation, and the wool as tempering abrupt changes of temperature. The shapes of the buds have no known meaning in particular — they are simply the passive result of the forms, numbers, and sizes of the parts inclosed within them.

**Physiology.** — This involves a continuation of the study of photosynthesis. The teacher should explain the chemical composition of the basal grape sugar ( $C_6H_{12}O_6$ ), of starch ( $C_6H_{10}O_5$ ), and of cane sugar ( $C_{12}H_{22}O_{11}$ ), and should show their simple interrelationships of proportion in connection with the proportions of water ( $H_2O$ ). Then he should

lead the students to see that the proportions of the hydrogen and oxygen in these substances suggest a probability that these elements are derived from water, of which plenty is absorbed from the soil; and he should explain that this in fact has been proven to be correct, though by methods too complicated for demonstration in this course. Then as to the carbon, they should be led to notice that it can come only from soil or air, and the method of water culture, whereby plants can be grown in water containing no carbon at all, can be described to show that the carbon does not come from the soil. This seems to leave only the atmosphere, in which it is present in very small quantity as carbon dioxide, which makes about .03 per cent (3 parts in 10,000) of the total bulk of the air. This should bring the students to face the question, whether plants can make use of the atmospheric carbon dioxide in starch making, a problem which can be solved experimentally thus. Prepare two large clear glass bottles, the larger the better, but of at least a gallon capacity, with air-tight, preferably rubber, stoppers. On the bottom of one place a covering of a strong absorbent of carbon dioxide, *e.g.* solution of caustic potash of about ten per cent strength, and on the bottom of the other, for a control, a covering of a mechanically similar but non-absorbing substance, *e.g.* water. (Theoretically water is also an absorber of carbon dioxide, but water drawn from a tap or other ordinary supply contains all of that gas it can absorb from the atmosphere. As it may give up part of this quantity to the air during the experiment, a new supply should be introduced each time the jar is used.) From a vigorous thin-leaved plant, kept over a day in darkness (to empty it of starch), take two similar small leaves and suspend them in the middle

of the bottles with their petioles through the stoppers of vials held in position by wires hung from screw eyes in the bottle stoppers. The arrangement is shown in Fig. 22. Stand

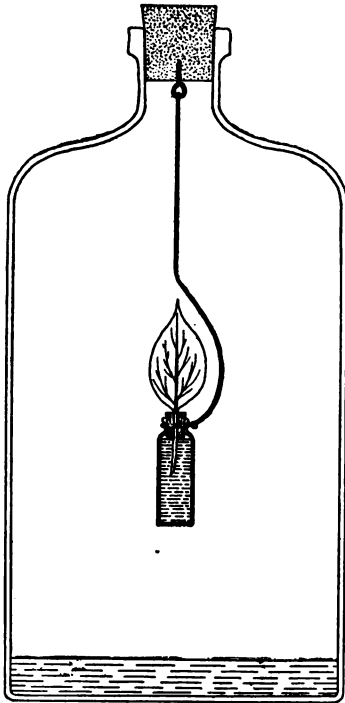

FIG. 22.—Arrangement for demonstrating the use of atmospheric carbon dioxide in Photosynthesis;  $\times \frac{1}{4}$ .

the bottles for a few hours in a bright diffused light at a temperature of about  $20^{\circ}$ – $22^{\circ}$ . Then remove and blanch the leaves and apply the iodine test, when, if the experiment has been correctly performed, the leaf which has been in the chamber deprived of carbon dioxide will remain white, while that from the chamber containing the carbon dioxide will become deep blue. The bottles, once obtained, should be reserved exclusively for this experiment, and if kept tightly stoppered, should always be ready for immediate use, without the need for renewing the caustic potash for several years. It is advisable also to take leaves

from the plant at the beginning and end of the experiment, keeping the former in water beside the jars, and then to test them for starch with those in the jar, as an extra control for the condition of the plant itself.



For success in this experiment, it is essential that the leaves be small in comparison with the size of the chambers, since otherwise there will not be enough carbon dioxide available in the control jar to permit the formation of a visible amount of starch. The experiment, often recommended, in which whole plants, or large parts of them, are placed in bell-jars, which are arranged to have communication with the air outside through openings guarded by the absorbing and control substance, though correct in theory, is fallacious in practice, since the admission of fresh carbon dioxide into the control jar is rendered so slow as to be practically impossible, and the supply in the chamber is exhausted at once. Instead of the large bottles one may use large bell-jars sealed by wax, or modeler's clay, to ground-glass plates, the caustic potash and water being placed in saucers and the leaves as before in vials; but this method is less convenient than the former. Or, one may use soda lime and powdered chalk as the absorbing and control substances, but I find that the use of the former tends to injure some leaves, probably because of the dryness it also introduces. Another way, very effective in that both experiment and control are on a single large leaf which remains attached to the plant, consists in sealing two parts of the leaf over the necks of two special bottles which replace the larger bottles of Experiment 5; full directions for this method are given in my *Laboratory Course in Plant Physiology*.

### **VIII. The Special Morphology and Ecology of Leaves, Stems, and Roots**

31. In the ten plants selected, what is the exact morphology and probable ecology of the specialized structures they show?

In each case your record should bring out clearly

(a) The evidence which proves their morphology.

(b) Reasons for your view of their ecology.

*The drawings need not include the entire plants, but only the special structures and their connection with other parts.*

32. In a sentence explain the idea you attach to the word "morphology"; also to "ecology"; and state your idea of the exact relationship between them.

33. A study of the release of oxygen in photosynthesis.

Inspection of the formula of the photosynthate with reference to its composition from water and carbon dioxide. The resultant implication that oxygen is released, which can be tested by experiment (Experiment 6). Relation of the volumes of carbon dioxide and oxygen concerned. The complete photosynthetic equation.

The part played by light in the process, the part by chlorophyl. Importance of the process as origin of both plant and animal food. Summary statement of Photosynthesis.

**Materials.** — These should be such as show the leaf, stem, or root modified more than in the preceding exercise, to such a degree, indeed, that they are metamorphosed into new organs carrying on new functions, and therefore are so altered in

shape, size, color, and texture as to conceal completely their original nature. Hence the materials should include plants possessing spines, tendrils, pitchers, tubers, aerial roots, and other specialized structures, of which there is a most satisfactory treatment in Chapter III of GRAY'S *Structural Botany*. The best source for such materials is an educational greenhouse specially cultivating plants of morphological interest. Next in value come specimens from the museum collection or herbarium, on which comments have been made earlier in this book (p. 158). Of course many plants of the native flora are admirable for this study if collected in season and suitably preserved. Supplementary to the plant material one can make good use of the many admirable pictures in KERNER and OLIVER'S *Natural History of Plants*, and in SCHIMPER'S *Plant Geography*.

**Suggestions on Teaching.** — This is one of the most valuable, and to students one of the most interesting, of all exercises; and there is nothing better for training in correct conceptions of morphology and ecology.

The students should be able in nearly all cases, using relative position as the guide, to work out with certainty the exact morphological origin of each part, whether metamorphosed from a root, stem, or leaf. Some of the special structures, e.g. thorns of roses, originate as special outgrowths or emergences of the epidermis and cortex, and they may be recognized by their irregularity of position. In practice all the special structures may be traced back to an origin in root, stem, leaf (with its parts, blade, petiole, and stipules), or emergence. But it should be made plain that these parts are not themselves of equal rank, nor are they irresolvable elements, but simply adaptive structures, traceable back to

still simpler origins in the thallus, as has been noted more fully on page 233 of this book.

The students will soon learn how little the shape, size, color, etc., of organs has to do with their morphology. Of course a complete knowledge of the morphology involves an understanding of the exact steps by which the new organ has been formed, *i.e.* in the case of a pitcher, whether the leaf has infolded and united its edges to form the cup, or (as is actually the case) whether it has grown up as a cup from the start. It will be well for the teacher to have some one or two series of specimens illustrating all the intermediate stages of a particular structure, such, for example, as a Barberry spine. In some cases the student will be able to imagine what the intermediate steps must have been; but in others this is impossible without a study of embryology, and here (as in the case of pitchers, for instance) it will be necessary for the teacher to supply information, which students will be prepared to appreciate and utilize after their minds have once been at work upon the problem. On the ecological meaning of the structures, they can, of course, do little more than guess. It is just here that outdoor study of native plants through field excursions is so valuable. However, in ordinary temperate climates, ecological adaptations are so much less marked than in tropical and desert plants, that it is necessary to make use of some of the latter in order to give anything like an adequate view of the subject. The teacher must then supply data as to their habits, describing the conditions of the desert, the tropical jungles, etc., illustrating by photographs as fully as possible. The teacher must carefully guard against dogmatism in ecology; at the best this division of the science is still in a very new and undifferentiated state, while even among

specialists much of it is but guesswork. A complete study of this subject would involve also an examination of the texture or tissues of the parts; for adaptation shows itself in the internal anatomy, in the suppression of some tissues and excessive development of others, as well as in external features. But this work is hardly practicable in a general course, except through demonstration and reading.

In this connection the teacher will find it advantageous to give a fully illustrated account of the very important and interesting subject of the ecological groups of plants, which groups may most simply be classified thus:—

**A. Groups showing special adaptations to physical conditions.**

1. Mesophytes, or Plants of optimum conditions.
2. Xerophytes, Desert Plants.
3. Halophytes, Strand Plants.
4. Hydrophytes, Water Plants.

**B. Groups showing special adaptations to other organisms.**

- |                               |                  |
|-------------------------------|------------------|
| 1. Climbers.                  | 4. Insectivora.  |
| 2. Epiphytes.                 | 5. Myrmecophila. |
| 3. Saprophytes and Parasites. | 6. Symbionta.    |

**Physiology.** — It is needful to complete the photosynthetic study. The final part of the subject may be treated very logically and clearly thus: If the teacher will bring up again the formula of the synthate, and have the students set it down in comparison with that of the substances from which its constituents are derived, thus,  $\text{CO}_2 + \text{H}_2\text{O} = \text{C}_6\text{H}_{12}\text{O}_6$ , and then, after explaining to them the nature of a chemical equation, make them figure the quantities necessary for the equation to balance, they will themselves derive this equation.  $6 \text{CO}^2 + 6 \text{H}^2\text{O} = \text{C}_6\text{H}_{12}\text{O}_6 + 6 \text{O}_2$ . This implies that oxygen

is released in this process, which important conclusion needs test by experiment. Although it can be tested perfectly by somewhat elaborate methods, there is no simple way that is wholly satisfactory. The most used of the methods is this: If one gathers a number of shoots of some plant growing

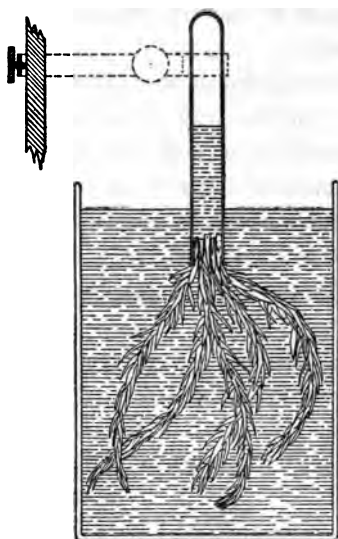

FIG. 23.—Arrangement for study of release of oxygen in Photosynthesis;  $\times \frac{1}{4}$ .

under water, *e.g.* Cabomba, Elodea, Ceratophyllum, and places the cut ends in an inverted water-filled test tube, as shown in Fig. 23, and leaves it some hours in light, a gas will rise from the stems and displace the water, finally filling the tube. Or, if the plant is one which does not give off the gas from the cut ends of the stems, one can place the plants under an inverted funnel which leads into a test tube of water, though care must be taken to use a very large dish in order

to give plenty of surface for access of fresh carbon dioxide from the air; and it is in any case a decided advantage to add some carbon dioxide to the water from time to time from a generator. Theoretically the gas thus released is chiefly oxygen, though in fact it contains also much nitrogen and carbon dioxide. If the weather is bright and the plants very vigorous, the oxygen may be abundant enough to ignite a glowing splinter thrust into it when the tube is inverted,

but frequently this does not occur. It is sometimes said in books that leaves of land plants can be used in this experiment, but that is wholly an error, for the gas such leaves seem to give off is only air dissolved in water and collected upon them. The most accurate method by far lies in the use of a phytosynthometer, which not only permits a complete demonstration that oxygen is released in photosynthesis, but also proves another important matter indicated by the equation; namely, that the carbon dioxide absorbed and oxygen released are equal in number of molecules, and therefore in volume. I shall not attempt here to give the rather lengthy directions for the use of this instrument, since the teacher likely to use it will probably have available my work on Plant Physiology in which it is fully described. By this method the photosynthetic equation can be fully demonstrated, and in any case the student should be made to fix it in his memory. It will be of interest for him to know also the approximate amount of the gases involved. A square meter of leaf surface in an hour of bright daylight absorbs from the air about 750 cc., that is,  $\frac{3}{4}$  of a liter of pure carbon dioxide, and gives off into the air the same amount of pure oxygen. This is equal approximately to  $\frac{3}{4}$  of a quart absorbed and given off by a square yard of leaf.

It remains to consider the part of light and chlorophyl in photosynthesis. It should be explained that the splitting apart of the carbon dioxide, a necessary preliminary to the formation of the sugar, is a difficult process requiring much energy, because the carbon and oxygen have an extremely strong affinity for one another; and it is known that light supplies the energy capable of doing that particular kind of work. Now, not all of the light has the power of doing this

work, but, as shown by experiment, only certain ones of its many rays, especially the red. The spectroscope applied to a solution of chlorophyl shows that it is precisely these rays which chlorophyl stops, while the useless rays, especially the green and yellow, are allowed to pass on; and it is these which come to our eyes and make chlorophyl appear its characteristic yellowish green. All the evidence shows that chlorophyl is a substance which has the power of stopping and applying these rays of light capable of splitting carbon dioxide. This subject can be beautifully illustrated by the use of the spectroscope, but probably most teachers will think this too special an instrument for introduction into a general course. If, however, one wishes to employ it, he can find full directions, with an account of a simple form especially adapted thereto, in my book on Plant Physiology. Finally the teacher should review the process in full, and should emphasize it strongly as the source of all food, both of plants and of animals, inclusive of man.

### IX. The Tissue Systems (or Anatomy) of Plants

34. In the Balsam, after observing the features of the external structure, study carefully the tissue systems of the shoot and root.

*All of these systems are to be worked out with simple lens and scalpel.*

#### I. The epidermal, or protective, system.

- (1) Is it continuous and uniform over the entire plant?
- (2) Is it smooth or has it appendages ?



- (3) Is it removable from the underlying tissues?
- (4) Does it, when removed, exhibit any features not before visible?

II. The cortical, or food-making, system.

- (1) Is it continuous over the entire plant?
- (2) Is it evenly distributed, and, if not, where is it most highly developed?

III. The fibrovascular, or conducting and strengthening, system.

- (1) Is it continuous through the entire plant?  
Place a spray in the red liquid to aid in tracing its course.
- (2) In what order are the bundles arranged in the stem?
- (3) In what order in the petioles?
- (4) In what order in the leaf?
- (5) In what way do they end in the leaf?

IV. The pith, or storage, system.

- . In a young woody stem, what systems may be distinguished?
- . Construct sectional diagrams showing by colors the distribution of the four tissue systems of the plant through stem, leaf, and root, as seen in both longitudinal and cross sections.
- . A study of the process of respiration.

**Work done by plants:** need for energy for all work:  
the sources of this energy: analogy with ani-

mals whose energy is derived from their food and is set free by their respiration. Do plants respire; that is, do they set free carbon dioxide and absorb oxygen? This can be tested by experiment (Experiment 7): relative quantities of the gases exchanged; the respiratory equation: occurrence of this process in other parts of the plant: quantities of carbon dioxide released: relations in place and time of this process to photosynthesis: reasons why the two processes do not neutralize one another: source of the actual energy.

**Materials.** — Balsam (*Impatiens Sultani*) is easy to raise from cuttings, and good for this use because of its translucent stem, which renders the fibrovascular system very distinct, though the distribution of its green tissue in the stem is not as sharply differentiated as in most others. But the roots, as in all cuttings, are small for effective study, though they may be shown very clearly in White Lupines grown for the purpose. Coleus is also very good, and almost any soft-stemmed greenhouse exogenous plant can be used. For Exercise 35 any young woody twigs are good, but those with a greenish bark are best.

**Suggestions on Teaching.** — This is one of the most useful of exercises, dealing as it does with an important phase of anatomy (*i.e.* the contact of, and transition from, the visible to the invisible) commonly overlooked. Of course the cells, while visible in pith and cortex, are not to be studied individually, but only the tissue systems, which show clearly by differences in color, luster, etc. It is extremely good for train-

ing in minute observation, and also constitutes valuable knowledge, for it gives a good comprehensive idea of the characteristics and distribution of tissues. Far more of minute anatomy can be traced out with the hand lens than is commonly supposed, and of course still more is possible with the dissecting microscope. For the best results in this study the students should previously have had their attention called, in some demonstration or lecture, to the general physiological conditions to which plants must adapt themselves, — to protection against drying up and against animal enemies, to need for exposure of much green tissue to light for food making, to aëration of the interior cells to allow them to respire, to conduction of raw sap to the leaf and of the food substances away, to provision of strength to resist winds and other strains, &c. With all these needs and functions fresh in mind, the students are prepared to find out how they are arranged for in the tissue systems of the plant.

Important points to be brought out are; — the lenticels on the stem (which are the successors, structurally and physiologically, of the stomata of the younger tissues): the greater intensity of the green on the upper, *i.e.* the best lighted, surface of the leaf: the branching of the bundles at the nodes, and the running of one branch into the leaf and of another up the stem: the fact that the bundles form a ring in the stem and that one, two, or three run out through the petiole and branch profusely, ending either as very small veinlets anastomosing, or else ending abruptly in small green areas (shows well in *Asarum*): the tapering of the veins regularly, with the mechanical reasons therefor. The point can also be brought out, though by demonstration rather than observation, that the cambium cylinder is con-



tinuous with the vegetative points, and with them forms a complete closed growth system. Using eosin or safranin, tumblers filled with red dye are easily prepared, and if cut shoots are placed in them, in a few minutes the fibrovascular system will be completely stained. Slides and covers should be supplied to allow students to mount all sections in water.

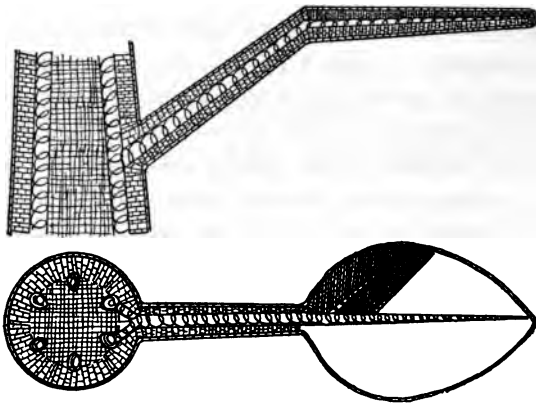

FIG. 24.—Diagram of distribution of tissues in a typical shoot, upper in longitudinal section, lower in cross. Outer lines = epidermal system; radiating lines = cortical system; crossed lines = storage system; spiral lines = fibrovascular system. On these systems see page 339.

Excellent thin sections can be made with their scalpels, which they may sharpen on the laboratory whetstone provided for the purpose. A diagram like that called for in Exercise 36 is shown in Fig. 24, where the colors are replaced by special shading.

**Physiology.**—Respiration ought logically to be studied along with some topic involving exhibition of work, such, *e.g.*, as some phase of growth or movement; but in any case it should follow immediately after photosynthesis, because the

two processes are confused in the minds of most people and can best be distinguished when brought together in sharp contrast. It can be approached in different ways, but after trial of several, I have found the following the most satisfactory. By reviewing the facts the students have seen in connection with growth and movement, they can be led to consider the considerable amount of work that plants do, as when they lift their parts against gravitation: swell and push out structures in growing: move tendrils and twining stems through the air: force roots through the hard soil and thicken them up against great resistance, even to lifting rocks or curbstones and destroying masonry in the process: making new cells, with the complicated processes: and in other minor ways. Then it should be made clear that work is work, no matter whether sudden and laborious in appearance, or slow and seemingly easy, and that it is the same in amount when the results are the same, no matter whether accomplished in one way or another. It should also be emphasized that for their work plants need a supply of energy or power just as certainly as do animals or a steam engine, both of which are known to stop dead when the supply of energy is cut off. Then attention should be turned to the source of the energy-supply underlying the work of animals, which everybody knows is derived from their food, while it is equally well known that the use by animals of this energy in food is somehow connected with their respiration. This leads to the question whether the energy for plant work can be derived from their food, which, in turn, raises the question whether plants respire. Since the most conspicuous manifestation of respiration in animals is well known to consist in the absorption of oxygen and release of carbon dioxide,

our question is reduced to this, Is oxygen absorbed or carbon dioxide released by the working parts of plants? The latter part of the process is easily tested by experiment and can be demonstrated strikingly by the following method: Select

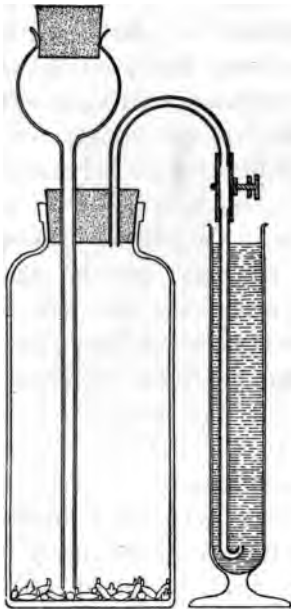

FIG. 25. — Apparatus for the demonstration of the release of carbon dioxide in respiration;  $\times \frac{1}{3}$ .

two similar wide-mouth bottles, and provide air-tight (preferably rubber) stoppers, bored with two holes for thistle tube and outlet tube, which are arranged as shown by the accompanying Fig. 25; and provide also the test tubes or other slender vessels as there shown. Soak for a few hours enough barley or oats to cover the bottom completely: then place them in one bottle and inclose them air tight, using a stopper in the thistle tube and a clamp on the rubber part of the outlet tube. The other is to remain empty, but otherwise like the first, as a control. Stand them in a warm place for twenty-four to forty-eight hours, and then, before the class, fill the

slender vessels with filtered limewater (the effect produced upon a similar tube of limewater by carbon dioxide from a generator, being first shown); open thistle tube and clamp and pour water down the thistle tube, when the air of the bottle will be forced to bubble up through the limewater, which it will speedily turn very milky, proving the presence

of plenty of carbon dioxide. The second bottle when treated in the same way will show that the small amount of carbon dioxide in the air of the bottle lacking seeds is not enough to produce any appreciable effect on the limewater. An advantage of this apparatus consists in the possibility of making the limewater tube of any useful size, either large enough to be seen across a large room, or small enough to be projected upon a screen. Another method, which to some extent will show the progress of the release of the carbon dioxide, consists in the use of a cylindrical bottle into which some limewater is placed at the start of the experiment, and above which is a diaphragm of wire netting supporting some thoroughly soaked oats or barley. When the bottle is tightly stoppered and placed under good conditions for growth, the gradual whitening of the limewater, made all the more evident by an occasional shaking of the bottle, gives an excellent demonstration of the release of carbon dioxide, especially if tried beside a control containing no seeds. Still a third method of showing the progress of the gas release in another way, lies through the use of respirosopes, several forms of which are described in my work upon Plant Physiology. Whichever apparatus is used, it should be carefully prepared and kept for use year after year; and if it is the instrument here figured, it should be provided with a suitable wooden tray, with handles and shallow round pits to hold the bottles in place.

There is, unfortunately, no simple method of directly proving the absorption of oxygen in this process, though it can be inferred from the fact that growing seeds, or other parts, deprived of it cease all growth and movement. The usual ways, however, of depriving the seeds of oxygen, by exhaust-

ing the air completely from the chamber in which they are growing, or by replacing the air by hydrogen or other harmless gas, are logically fallacious, since the result is just as much a proof of a need for nitrogen as for oxygen. A logical method must be one in which only the oxygen is removed.

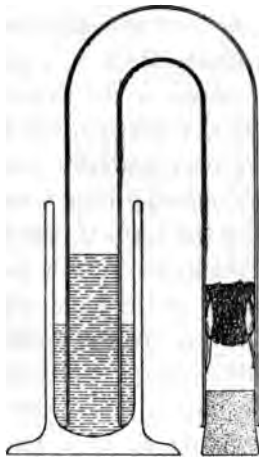

FIG. 26. — Apparatus for the demonstration of the need for oxygen in growth;  $\times \frac{1}{2}$ .

This can be accomplished by use of an absorbent known to remove oxygen but not nitrogen; and a suitable arrangement, available for demonstration, is shown by the accompanying figure (Fig. 26). In an ordinary U tube, place a wad of wet sphagnum moss or cotton wool in such manner that some soaked oats, or other convenient seeds, are held pressed against the side of the tube some distance above one end; stand the tube, with the end covered, in a place favorable for growth, until the roots have grown a few millimeters long: then close this end of the tube air tight with

a rubber stopper, and place the other in a solution of pyrogallate of potash, which will absorb all oxygen in the tube within an hour, and will rise (driven by external atmospheric pressure) to take the place of the absorbed oxygen. The position of the tips of the roots may now be marked on the glass so that any further growth will thus be made visible. A similar tube forms a good control for proving that the seeds are not killed by fumes from the solution used, for if, after the oxygen is all absorbed, the tube be opened, the seeds



will grow on as well as before, although of course they are killed by an absence of oxygen for some hours. The pyrogallate of potash is made by dissolving 1 part by weight of pyrogallic acid in 15 parts of water, and 5 parts of caustic potash in 15 parts of water, and mixing these at the moment of use. It is best to use them in a vessel which presents as little surface as practicable to the external air (the oxygen of which it also absorbs, of course) after the U tube is inserted. The absorption of oxygen may, however, be directly and clearly demonstrated in conjunction with the release of carbon dioxide, and the relative volumes of the two involved may be determined, all in one operation, by use of a demonstration respirometer pictured and described with full directions for its use, in my work on Plant Physiology.

If the teacher uses only the former demonstration experiment, he will need to explain that oxygen is known to be absorbed, and can be shown by experiments which are, however, too difficult for present use. The common and easy experiment often recommended as demonstrating the release of carbon dioxide, viz. the extinguishment of a lighted candle lowered into a bottle containing seeds which have been germinating for some hours, is wholly inconclusive, since the same result might equally be due to deficiency of oxygen, or to formation of some other gas incapable of supporting combustion; and some other experiments in this connection are also erroneous in minor ways, as I have pointed out in my work on Plant Physiology.

The teacher should explain in the demonstrations the other matters of importance indicated under Section 37. If barley, oats, or other very starchy seeds are used, the two gases exchanged are practically the same in quantity, but in

other kinds the ratio may be very different, though in the long run and after many complicated intermediate steps, this equality is found to hold. Hence we derive the respiratory equation:  $C_6H_{12}O_6 + 6 O_2 = 6 CO_2 + 6 H_2O$ . This equation, however, does not by any means express an actual chemical process, for the intermediate chemical stages in respiration are many and complicated; but it is simply a convenient conventional expression for the end results of the process.

It should, of course, be made plain that respiration occurs in all parts of all living plants at all times whether photosynthesis is proceeding or not, and that the processes are going on together in leaves in the daytime. The reason why the one does not neutralize the other is found in their very different rate, for while a square meter of leaf in an hour of daylight absorbs 750 cc. of carbon dioxide, the same area in the same time releases only 60 cc. Seeds and buds release much more, but never to a quantity sufficient to offset photosynthesis in any given plant. In a general way the respiration in any given green plant probably does not exceed one tenth of the photosynthesis. Finally, the teacher should explain the actual source of the energy as clearly as he can, though it is a hard matter to make plain to young students. In brief, when sunlight originally split apart the carbon and oxygen of carbon dioxide in photosynthesis, the energy thus used went into the potential or resting form; and so it remains as long as the carbon is held unoxidized in the food, no matter through what changes and transformation this may pass. When this carbon in the food is allowed to reunite with oxygen, however, this potential energy passes again into the active form and, being released at the right place and under

the right mechanism, does the required work of the plant. The teacher can here usefully employ the comparison with the storage battery used in electric automobiles, where the electrical energy goes into the potential form in dissociating the lead compounds in the battery, and is released again as electricity when those compounds are again allowed to reform. Respiration, therefore, is simply the method of permitting the recombination of oxygen and carbon forcibly separated in photosynthesis, energy under such circumstances being always released, precisely as it is in the closely analogous process of combustion of coal. And, above all, the teacher should make it plain that the release of energy is the real end of the process, the exchange of gases, despite its prominence, being merely incidental to that.

### **X. The Structure of the Cells of the Higher Plants**

38. Make yourself acquainted with the general construction and mode of use of the compound microscope, following directions to be given you.

Learn to use always these precautions:—

- (1) Lift the microscope (where it has no handle) only by the parts under the stage, never by the fine adjustment pillar.
- (2) In focusing (where there is no rack and pinion), support the outer tube by the left hand and use the right to push, with a spiral motion, the inner tube downwards; watch the descent of the tube from one side until it

reaches the approximate focal position, and (especially with the high power), make sure it does not strike the cover glass.

- (3) Use the fine adjustment screw only for sharpening the image of the object, never for bringing it into sight.
  - (4) Keep the pillar always towards you, and make sure of the best light from the mirror.
  - (5) Learn to work with both eyes open.
  - (6) Experiment in focusing, and learn that turning the fine adjustment screw clockwise means down, and counterclockwise up; experiment also in moving an object, taking note of the reversal.
39. Study the structure of a living cell, as exhibited in the epidermal hairs of the Cucurbita.
- (1) What is the shape, not only in length and breadth, but in all three dimensions?
  - (2) What structure has the wall, including that between two cells? Is it homogeneous, or has it openings or markings?
  - (3) What is the appearance presented by the protoplasm? Does it completely fill the cell? Has it any motion?
  - (4) Do you find a denser rounded body (nucleus)? If so, what structure has it? Is it surrounded by the cytoplasm?

- (5) Are there any chlorophyl grains, or anything resembling them?

Study in the same way some other cells.

40. A study of the process of Fermentation.

Release of carbon dioxide not confined to respiration; other cases, including fermentation: the yeast plant. Experimental study of the release of the carbon dioxide (Experiment 8). Other products of fermentation; economics of fermentation; significance to the plant causing it and relation to respiration; analogous processes in decay and bacterial action.

**Materials.** — For this work there is needed some good example of a typical living plant cell, showing all of the usual parts, viz. nucleus, cytoplasm (in active streaming), vacuoles, and wall, with plastids, if possible. For this the best object known to me for every feature except the plastids, is the stamen hair of the Spiderwort, *Tradescantia virginiana*, which is easily obtained in gardens in late spring and summer, but not at other times unless the plants are cut back in the spring, when they may be made to flower in the late fall; if covered at night by a frame and sash, or if brought into a cool greenhouse, they may be kept in good condition until near December 1. The Wandering Jew, *Tradescantia zebrina*, common in greenhouses, has hairs less excellent, but serviceable.

But these materials are not often available, and nearly as good (in some ways quite as good) are the hairs on the new leaves of squash plants (*Cucurbita*), which are easily grown

from seed for the purpose. The Hubbard Squash is the best, and if grown in a very sandy soil, beginning with small pots, can be brought into perfect condition, with abundance of hairs, in six or eight weeks. Several plants found in greenhouses, however, have good hairs, notably Gloxinia, Abutilon, Tomato, Heliotrope, some Pelargoniums, and a number of others, which are listed, together with data concerning the rate of streaming of the protoplasm, by GRACE BUSHEE in the *Botanical Gazette*, 46, 1908, 50. The streaming of the protoplasm in these cells is a phenomenon more striking than important, and the students must not be allowed to think that it is a universal attribute of living protoplasm. The streaming has an incidental value in connection with this subject, however, as proving that the protoplasm is alive and in good condition. It shows with particular clearness in the species of Stoneworts, *Nitella* (or *Chara*), which grow in ponds and slow streams and may be kept alive in greenhouses in tubs all winter. It is also desirable to have at hand some mounted and stained slides of various cells for purposes of demonstration in extending a knowledge of cell structure.

**Suggestions on Teaching.** — This work is of great importance, and likewise always of deep interest, to the students, since it introduces them to the actual use of the best-known and most essential tool of biological study, — the microscope, — while at the same time giving them a knowledge of the living plant cell. If well managed, the work is by no means difficult, and certainly it should never be omitted except under direst stress of lack of instruments or material.

The desirable microscope for use in the general course has already been fully considered (p. 126). At the outset,

the status of the microscope, as simply an aid to vision, and not a creation with mysterious powers of its own, should be made plain to the students. Before this they will have learned to use simple lenses, and on the basis of this latter knowledge, the principle of the compound microscope may be briefly explained as an arrangement in which a magnified image of the object (given by the objective) is further magnified by the ocular. To insure a sane and safe manipulation of the instrument, the teacher should begin with a demonstration of the mode of handling the microscopes, starting with these still in their cases, and directing the students collectively in the first withdrawal, setting up and focusing of the instrument, with comments on its care, the names of its parts, etc. For the first steps in focusing, moving of objects, etc., it is well to use some object already familiar to the eye, for which purpose the simple device of words in fine print attached to glass slides is sometimes employed; and on these or something equivalent the students should practice the use of the instrument before proceeding to the living cells. In passing to the study of the living cell, however, every step of removing the hair by knife or forceps, of placing it in water in the middle of the slide, and of dropping on it a cover glass in such a manner as to exclude air, should be performed, under the teacher's direction, by the students themselves. With good material, they should be able to see all of the principal parts of the cell, and to draw them well. In this connection the teacher should review the advice, earlier given (p. 102), as to drawing of cells. The cells should be drawn as seen in optical section. In the demonstrations the teacher should make it plain that, despite its apparent insignificance, the protoplasm is the

important thing in the cells; and of course he will explain the general function of all of the principal parts, and point out that the word "protoplasm" applies to all the living contents of the cells, which are composed of cytoplasm, nucleus, and plastids. In a demonstration, the teacher should take

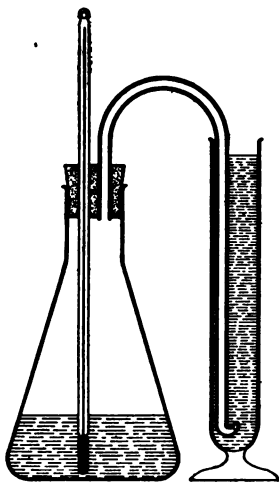

FIG. 27. — Apparatus for the demonstration of the release of carbon dioxide in fermentation;  $\times \frac{1}{2}$ .

up the subject of protoplasm, giving a general account, with as abundant illustration as possible, of the range of texture, hardness, color, etc., of the substance, with some of the interesting facts about it as the sole physical basis of life, some reference to its chemical composition, and some discussion of its origin with reference particularly to spontaneous generation.

**Physiology.** — The great scientific interest and vast economic importance of fermentation combine to make desirable the introduction of its study into any elementary course. It comes naturally immediately after the study of respiration (for course fermentation is simply the yeast's respiration), and the teacher may lead up to it by a discussion of headings given under Exercise 40. The experimental demonstration of the release of carbon dioxide is very easy; it is only necessary to place in a flask or bottle some strong solution of sugar (say 15 grams to 100 cc. of water), add thereto a cake of compressed yeast, stand the whole in a warm place (about  $28^{\circ}$  C.),



when fermentation begins within a few minutes, though it may take nearly an hour to develop enough gas for a good demonstration. In a class-room demonstration, the warmth can be given by placing the flask over an incandescent electric light bulb, with some black cloth between. If, now, a suitable outlet tube has been provided, as shown in Fig. 27, the gas, as it comes off, will be led to the bottom of a tall vessel containing filtered limewater, up through which it will bubble in a way to form a very striking demonstration, proceeding before the eyes of the class, that carbon dioxide is a product of fermentation. Unfortunately, no such clear demonstration of the other principal product, alcohol, is possible. The characteristic odor yielded on application of the iodoform test for alcohol (as described in all works on chemistry) is given by the liquid in the flask, but very badly. The usual method is that of distilling the liquid and applying the test to the distillate, which is conclusive, but difficult of manipulation.

## XI. The Anatomy of Leaves

41. Study the structure of the protective (epidermal) cells of a typical leaf.

- (1) What is the shape of the cells?
- (2) Have they nuclei, chlorophyl grains, visible cytoplasm, or any cytoplasmic movement?
- (3) Can you find the openings (stomata) between them, and are the bordering (guard) cells different from others?

*Answer by a study of the epidermis of Tradescantia, which may be peeled off after observation of its char-*

*acters as seen in position, and also of the prepared section of Barberrry leaf.*

42. Study the structure of the food-making cells of a typical leaf.

(1) What is the shape of the cells? Do these differ in different parts, or towards different surfaces, of the leaf?

(2) What is the structure of their protoplasmic parts?

*Answer by study of the Barberrry leaf from prepared sections, after observation of its characters as a whole.*

43. Study the structure of the strengthening and conducting (fibrovascular or vein) cells of the leaf.

In the cross sections of the bundles, can you distinguish between the thick-walled strengthening cells, and the conducting cells, the latter of two kinds?

44. Study the structure of the aëration (intercellular) system.

(1) Do you see any evidence of its continuity through the leaf?

(2) Do you find its connection with the outside atmosphere through the stomata?

*Answer by study of the prepared sections, and finally show all of the systems, including the epidermal, in a single drawing.*

45. Examine leaves of the rose, tracing the veins to the end. Then study prepared slides of this leaf.

#### 46. A Study of Transpiration.

Familiar phenomena showing that leaves give off water in the form of vapor; the exact amount should be readily determinable by experiment for day and night under ordinary conditions (Experiment 9). Results of many determinations: effects of external conditions on the process: correlations with the anatomy of the leaf: action of the guard cells: physiological meaning of transpiration.

**Materials.** — There appears to be no single known leaf which shows all of the tissues in typical condition, while at the same time practicable for study by students in the general course; hence it is better to use different leaves for a first study of the tissues and to gather up their connections, etc., by a study of some single leaf. Moreover, since it is practically impossible for students to make hand sections of leaves sufficiently thin to show the details of cellular structure, these must be prepared beforehand by the teacher, either freshly cut, or mounted and stained.

For epidermal cells the best leaf known to me is that of the Wandering Jew (*Tradescantia zebrina*) of greenhouses. Those with a purple under side are best, since by holding them up to the light one can see with a hand lens, and almost with the naked eye, the guard cells showing bright green against the purple; moreover, the epidermis can be removed very easily by starting a bit with a knife point, and then stripping it away, when of course it should be mounted at once in water under a cover glass. Other plants with easily removable epidermis are the Marguerite (*Chrysanthemum fru-*

*tescens*), Cyclamen, Horseshoe Geranium, Sunflower, and others which are named, along with many facts about the sizes, numbers, and visibility of stomata, considered from the present point of view, in an article by SOPHIA ECKERSON in the *Botanical Gazette*, 46, 1908, 221. For the entire internal anatomy, leaves of India Rubber Plant (*Ficus elastica*) are very good, except that the epidermis and stomata are of unusual type. This leaf has the advantage that it is possible to make fair sections with scalpels and good ones with razors, though prepared and mounted microtome sections are necessary for the full demonstration of cellular anatomy. Such sections, if made across the veins running out from the midrib, show the interior tissues very beautifully. A better all-round leaf is that of the Barberry, while the Rose is nearly as good, and has the advantage of showing very clearly the mode of ending of the veins in the green areas of the leaf.

**Suggestions on Teaching.** — This work is important for training in manipulation of the microscope, for microscopic observation, and for giving a knowledge of the very important subject of cellular anatomy. The teacher should be careful, however, at this stage, to have the students correlate microscopic with macroscopic observation by insisting that they look carefully at all objects first with the naked eye, and then with the hand lens, before resorting to the microscope.

Under Exercise 41, the important points for observation are, — the forms of the guard cells: the fact that they are in pairs, and not part of a single ring-formed cell: that they have chlorophyl: that nuclei show in the other epidermal cells. The importance of the protoplasm, despite its incon-

spicuousness, needs constant emphasis. In drawing the cells, the students should represent them as complete structures with definite walls, not simply as shaded masses. The functions of the different kinds of cells, the reasons for the difference between palisade and spongy layers, the importance of the aëration system and of its connection with the stomata, the action of guard cells, the mode of ending of the fibrovascular bundles in the leaf parenchyma (which, by the way, can be seen very clearly with the naked eye in leaves of *Asarum*, and with a lens in the leaf of cabbage), the meaning of the occasional crystal-holding cells, the mutual interrelations of position of the tissues, the forms of epidermal growths,—all of these will of course be considered in the demonstrations in connection with the functions of the leaf.

**Physiology.** — Having completed, as far as is appropriate to a general course, the study of the two most fundamental physiological processes of the plant, the natural sequence of topics would bring next the study of absorption and elimination of the substances used in these processes. Closely connected with the absorption of water is its transpiration, and as this is chiefly a leaf process we may best consider it along with the leaf structure. It is a subject which invites a great amount of satisfactory experimental study, but of course should be treated in the general course only in its most essential features. After calling the attention of the students to the way in which water collects on any glass walls surrounding plants (*e.g.* ferneries, windows full of house plants, etc.), the teacher may prove that this moisture is derived (mostly, at least) from the leaves and stems, by wrapping the pot and earth in a waterproof covering and surrounding the whole with a bell-jar, or by inserting the top

in a bell-jar through an opening in a split cardboard made to form the bottom of the bell-jar. The same end may be attained more simply by placing the petiole of a leaf through a small opening in a cardboard resting on top of a tumbler nearly filled with water, the leaf being covered by a similar tumbler inverted. It is very easy to determine the transpiration experimentally, the best method being that of weighing a potted plant in which all evaporation from the pot and earth are prevented by a suitable water-tight covering. There are many ways of effecting this latter object (all described in my book on experimental Plant Physiology), but the best is this: Inclose the pot in a tight metal cover, such as one of the aluminum shells made expressly for the purpose, as shown in Fig. 28, or replace the pot by a tin can (with added earth to fill the extra space). Roof the shell or can over by rubber tissue ("rubber dam" of dentists), in which has been cut a round hole a little smaller than the stem, with a slit thence to the edge of the piece; place the rubber around the stem and stretch it a trifle so as to make the cut edges overlap, and then seal these together with liquid rubber cement (obtainable everywhere in small tubes), holding the parts together for a few minutes until the cement becomes firm: then run a line of this cement along one margin of the cut, quickly overlap the other upon it, and hold firmly until the cement has set. Finally, fasten the loose margin to the metal shell or can, either by the strap provided (on the aluminum shell) for the purpose, or by a copper wire twisted with a single turn permitting it to be easily released. Then cut away the surplus margin, and there will remain a perfectly tight, neat roof readily removable at any time for watering the plant and renewing the air at the roots. It is

in this latter feature, one which means much to the continued health of the plant, that this method is superior to all those in which the roof is kept fixed and the water is added through a funnel or thistle tube. Or, one can place the pot entire in a suitable glass jar (*e.g.* a battery jar), making the roof as



FIG. 28. — Aluminum shell, roofed with rubber, for preventing evaporation from soil and pot;  $\times \frac{1}{4}$ .

just described. It is now only necessary to weigh the plant on a good balance, the more accurate and sensitive the better (the Harvard tip-scale used in experiments in elementary physics is fair), but if the available balance is not very sensitive, then the larger the plant the better. If the plant is started well watered, then it is only necessary to weigh it at intervals, and, lifting the rubber roof, once a day to make up the loss of the preceding twenty-four hours. At

the same time one should puff out the old air displaced from the soil by the water, and the plant will keep healthy for an indefinite time. If the experiment is tried in the short days of winter, it is well to make the weighings morning and evening, eight hours apart, which will permit a comparison of an eight-hour day period with a sixteen-hour night period, and therefore a determination of the comparative loss per hour day and night. Since the absolute amount of transpiration must vary with the size of the plant, it is desirable to determine the leaf area of the plant, which is easily done by tracing the outlines of the leaves on cross-section paper, or by other methods given in the suitable books; the results should then be reduced to a standard of grams per square meter per hour, a method which allows the transpiration of plants of different sizes and of different kinds to be directly compared. It has been found that greenhouse plants under ordinary conditions transpire, on the average, about 50 grams of water per square meter per hour by day and 10 grams at night, though the quantities range very much above and below this mean in the case of particular plants. The general effect of external influences can be shown by placing the plant on successive days in places of very different conditions as to darkness, dampness, cold, etc., and there are other very excellent and striking methods for experimentally testing this matter, especially that by the use of potometers described in the suitable books. An instrument has been invented, called a transpirograph (included among the normal apparatus mentioned earlier on p. 134), which makes a plant mark its own transpiration, with great accuracy, upon a drum; and by its use transpiration can be determined with precision continuously through day and night



for a week. If, simultaneously, the various external conditions are also recorded, a direct determination is possible of the effects of external conditions upon transpiration.

The best of the plants readily available for transpiration studies in winter, together with the exact quantities they give, have been determined and described, from the present point of view, in a paper by GRACE CLAPP, published in the *Botanical Gazette*, 45, 1908, 254. She shows that the best, in order of excellence, are Sunflower, Tomato, Lady Washington Geranium, Marguerite, White Lupine, Fuchsia, Garden Nasturtium.

In a demonstration the teacher will, of course, discuss the other topics mentioned in Section 46. The available evidence seems to show that transpiration is chiefly a purely physical process of evaporation from the moist interior of the leaf to the drier outside air through stomata which must be open for the passage of gases, but that it is somewhat, though slightly and clumsily, controlled by the action of the movable guard cells. It has apparently little physiological utility, or at least it is copious far beyond any demand of utility; on the contrary it may become a source of great danger, and this fact explains the existence of many striking adaptations which secure protection against it.

## XII. The Anatomy of Stems

47. Study the structure of a well-marked fibrovascular bundle in a young stem cut lengthwise.

- (1) In what general features do the cells of the bundle differ from those outside of it?

- (2) What lengths do these cells exhibit? Can you find any cross walls?
- (3) Can you distinguish ducts from sieve tubes? In what positions do the rings and spirals occur?
- (4) Can you find any cytoplasm in the cells of the bundles? Any nuclei?

*Answer by a study of the prepared sections of Cucurbita.*

48. Study the cellular structure and distribution of each of the tissue systems in a representative of one of the two leading types of stems, viz. the Corn.

- (1) Of what kinds of cells, and in how many layers, is the epidermis?
- (2) What is the structure of the cells within the stem outside of the bundles? Can you distinguish cortex from pith?
- (3) What is the structure of a fibrovascular bundle? Is there any cambium? In what order are the bundles distributed?
- (4) Do you find any aëration system?

*Answer from a study of sections made by yourselves, in conjunction with prepared slides. Show in one drawing, along a narrow band from center to circumference of the stem, the characters of the cells, including those of one complete fibrovascular bundle. In a diagrammatic drawing, show the distribution of the tissue systems by colors.*

49. Study the cellular structure and distribution of each of the tissue systems in a representative of the other of the two leading types of stems, viz. the *Aristolochia*, observing both young and old stems.

*Follow in this study the outline of the preceding subject.*

With the oldest *Aristolochia* stem, compare a piece of oak wood, and determine the homologous parts. Can you understand the relations of the structure of wood to the fibrovascular structure of stems?

50. What are the principal facts involved in the transfer of water along stems, as to the quantities, distances, and paths of the current? What is the present belief as to the explanation of the physical forces which underlie this work?

**Materials.** — The crucial feature of stem structure is of course the fibrovascular bundle, of which, therefore, the student should acquire a clear knowledge. But as it is very difficult, with most stems, to make sections thin enough to show well the bundle constituents in longitudinal section, it is best for the student to study first a stem in which these constituents are unusually clear, and such a stem is offered by the Squash (*Cucurbita*). Mounted and stained sections, showing both cross and longitudinal sections under the same cover glass, are best. For the other two stems, Indian Corn, which must be collected in summer and preserved in two per cent formaline (and, to remove the fumes irritating to the eyes, thoroughly washed just before use), and Dutchman's Pipe (*Aristolochia Siphon*) which grows in most cities

as a porch vine and which may be taken at any time of year, are admirable. Of both stems, material for the students to section, and also mounted sections, should be provided.

**Suggestions on Teaching.** — This work both continues the training and extends the knowledge of the preceding section. It offers good opportunity for training in the manipulation of sectioning, which can be done fairly with sharp scalpels, and much better, of course, with razors. The mounted sections should be given the students only after they have done their best with their own. After students have once a good idea of the general structure of the constituents of the bundle, they can work advantageously with cross sections alone, at least with respect to the distribution of the tissue systems. As matter of observation the companion cells, square in section, at the angles of the sieve tubes in Corn, should be clearly seen. Both Corn and Aristolochia are well differentiated stems, exhibiting the tissues beautifully, and this work ought to interest students much. Some good work in a study of the development of tissues, suitable for a special topic, is afforded by the Aristolochia, which, if studied by sections made at intervals from the tip back to the old stem, shows clearly the stages in development of some special tissues, including the sclerenchyma ring, the bark, the annual rings in the bundles, and the continuous cambium ring. The Aristolochia allows also the transition to be traced from the separate bundles of young stems to the solid woody mass of older wood, with its medullary rays, etc. Wood structure is illustrated especially well in oak, where the student may find for himself (presumably much better by the intermediation of young twigs), the fact that the shining plates of quartered oak are the medullary rays. In this connection the

structure of other woods, especially when studied along with sections of their young twigs, is of great interest, particularly as most of the tissue systems of stems can be recognized by aid of a hand lens without the use of the microscope. In connection with wood structure, the teacher should explain the principle by which wood is converted into pulp and used in the making of paper, and he should consider the value of various kinds of wood as timber.

The construction of the colored diagrams under Exercises 48 and 49 is very valuable as a morphological study, and will serve to impress firmly on the student's mind the fundamental differences between the two leading types of stems.

The systems of tissues of plants can be considered either from a physiological or a morphological point of view, the former being much the more important to general students. The two points of view coincide in large part, though not wholly, as may be seen in the following:—

### TABLE OF THE SYSTEMS OF TISSUES

<i>Physiological Systems</i>	<i>Name of Cells</i>	<i>Morphological Systems</i>
Protective	{ Epidermis Cork	Epidermal Cortex (usually)
Food making	Green parenchyma	Cortex
Conducting	{ Ducts Sieve tubes	Xylem (part) Phloëm (part)
Growth	Cambium	Cambium
Strengthening	{ Wood fibers Bast fibers Sclerenchyma	Xylem (part) Phloëm (part) Cortex (part)
Storage	Colorless parenchyma	{ Cortex (part) Pith Medullary rays
Aëration	Intercellular spaces	

**Physiology.** — Belonging naturally with the study of stems is the study of the process of water transport through them. The subject, however, though of great importance and interest, is one on which little experimental demonstration or illustration is possible. The path of the ascending sap current can be shown in various cut stems by immersing them for a time in water colored by eosin, or other very soluble stain, and later sectioning them at different heights; but nothing as to the physics of the ascent can be illustrated in this course, especially since the matter is not yet settled. Nevertheless, the teacher should treat the subject in class, first explaining the problem, especially as to the great amount of work done by trees in raising so much water. Some large trees give off one thousand pounds of water in a single hot day, and if a tall tree of over one hundred feet height be considered, it can be shown that the work required to raise this amount of water to that height is almost the same as is needed to carry some six hundred ordinary bucketfuls of water up an ordinary flight of stairs. In some such way the problem can be familiarized so that the students will appreciate the energy needed. The explanation of the physics of the process is still doubtful, but it is easy to show that the popular explanation of "suction" *i.e.* capillarity, is wholly inadequate, while the former scientific belief that the water is forced up by the action of living cells is quite disproven. Most students to-day accept the traction theory of DIXON and JOLY, *viz.* that in thin threads, such as occur in the ducts, water, by the mutual cohesion of its molecules, hangs together like a solid thread; the upper ends of these threads are drawn into the leaf cells by osmosis (a process soon to be studied), thus lifting the entire thread. From

the leaf cells the water is forced out by evaporation (transpiration), the energy for which is derived from the heat surrounding the plant. Thus in a general way the power which lifts water up the stems of tall trees is the same as that which raises it into the clouds.

### XIII. The Anatomy of Roots

51. Study the external structure of the young roots of the Radish.

- (1) What distinct structures are visible?
- (2) What is the structure, distribution, and mode of connection of the root hairs with the root?
- (3) What is the structure of the tip?

How much of the internal structure can be seen without sectioning?

*Something more becomes visible if the root is immersed for a few minutes in strong caustic potash, then washed and mounted in water on a slide.*

52. Study the internal structure of a typical root as shown by sections.

- (1) What is the structure of the cells, and arrangement of the tissue systems?
- (2) What differences of distribution exist between these root tissues and those of the stems earlier studied?

53. A study of the absorption of water by plants.

Structure of the parts most concerned in absorption:

character of the cell membranes: substances inside and outside of the cell. Can absorption of water take place as a physical process under such conditions? This may be determined by experiment (Experiment 10). Comparison of the conditions and results of this experiment with those prevailing in roots.

**Materials.** — Roots are much alike as to their external structure and appearance (as is to be expected from their necessarily very uniform habits), and those developed from any of the common seeds are good. Radish, however, is especially good, and the best of material may be obtained thus. Take a small, very clean porous flower-pot saucer, and place therein some seeds of radish previously soaked for two or three hours; cover with a similar but inverted saucer, and stand in a larger and similarly-covered saucer kept supplied with enough water to hold the seed saucer thoroughly saturated but not overflowed on the bottom. In three days the roots, and especially the hairs, will be beautifully developed. This arrangement, by the way, constitutes one of the best of germinators, useful in many ways, and is figured herewith (Fig. 29). Very good also is a flower pot inverted with the hole stoppered, and stood in a saucer of water; the soaked seeds will cling to the inner wall and develop the hairs beautifully. The air should be renewed daily by gently puffing it from the germinator. The hairs wilt quickly if much exposed to the air, and therefore it is best to have as few students as possible use one saucer. It would be well also to have a few of the seeds sown at the same time



in soil to illustrate the growth of the root hairs therein. Immersion in caustic potash, of about twenty per cent strength, will make the roots translucent, and bring out clearly the spiral vessels and air passages, which indeed in some roots, e.g. mustard, show clearly without this treatment. Potash is a very irritating and destructive substance; it should be handled with caution, and everything with which it comes into contact should afterwards be thoroughly washed.

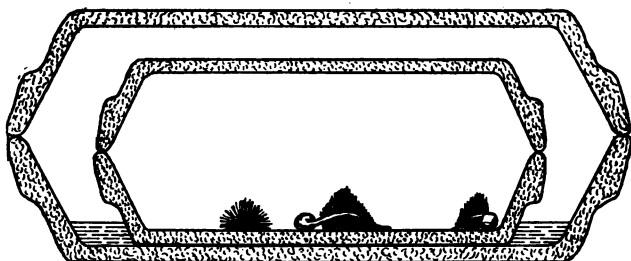

FIG. 29. — Germinator made from flower-pot saucers;  $\times \frac{1}{2}$ .

For the study of the anatomy of the shaft, some of the very large roots of tropical plants, e.g. *Alocasia odora* or the *Calla* (*Richardia africana*) or *Crinum*, are best; but nearly as good and much more accessible are the roots of hyacinths, very easily obtained from any potted plants when the pot is inverted and the plant jarred out into the hand. These are so large and well differentiated in their anatomy that very good sections can be made with scalpels alone (especially if a bunch be cut together), though of course razor sections are needed for the best results.

**Suggestions on Teaching.** — Like the two preceding exercises, this is needful for an understanding of plant anatomy, while likewise an excellent exercise in observation. Under

Exercise 51 all students should make out the fact that the zone of root hairs advances with the tip, and the method thereof; and they should be led to see that the young roots form closed structures without any determinable openings. They should further observe that the ducts extend down to the region of the root hairs. The character and meaning of the growing point, and the function and mode of growth of the protective cap, should also be made plain.

**Physiology.** — This subject of absorption naturally belongs with the study of roots. The teacher should lead up to it through a review of the laboratory study of the structure of roots, pointing out that the ducts, which are the water-carrying structures, come close down to the tip, but that no openings from the outside exist; and hence the water must pass into them through the cell walls, which in turn exhibit no openings discoverable by the most powerful microscopes. Then he should add the information that the cells of both hairs and cortex contain considerable sugar in solution, while the water outside contains only minute quantities of certain minerals. These are all of the parts concerned, and the question arises whether, under these conditions (*e.g.* where there is a membrane with sugar solution on one side, and water on the other), water will pass through the membrane. This is readily tested by experiment, as follows: Prepare an osmoscope as shown in the larger illustration of Fig. 30. The membrane is supplied by parchment paper tubing, of 40 mm. diameter, obtainable at insignificant cost from all supply companies. A piece some 15 cm. long should be soaked for a few minutes in water, then plaited and tied tightly with waxed thread at one end, thus forming a cup. Then the other end should be tied tightly over a stopper, of

suitable size, which must be air-tight (either through soaking in melted paraffin, or, preferably, being rubber). For a sugar solution, molasses, the color of which makes it readily visible, is very suitable; and it is to be poured into the cup through one of two holes left in the stopper. Into one hole is then inserted a stout tube of about 50 cm. length and 1 mm. bore (a smaller size works badly because of the viscosity of the molasses), which is all the better if pear-shaped in section, therefore giving magnification to the bore, and white-backed. Into the other hole is inserted a small separatory funnel, provided with a stopcock. The cup is then supported upright (conveniently effected by aid of a cork stopper placed on the long tube) in a vessel of water, which, for quickest results in the experiment, should be lukewarm. Enough water should now be poured into the funnel to raise the molasses into the tube; then the stopcock should be closed, when almost immediately the liquid should begin to rise in the tube, and should rise at the rate of several millimeters per minute, so that its movement can actually be seen even from a considerable distance. As it nears the top of the tube,

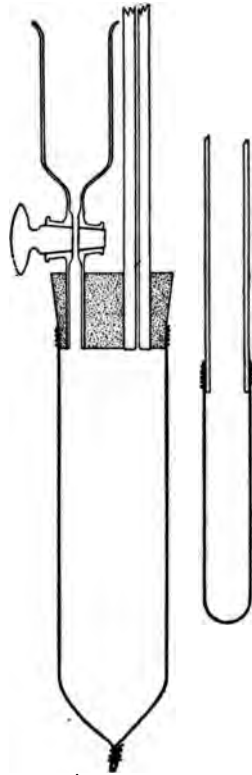

FIG. 30.—Demonstration Osmoscopes;  $\times \frac{1}{2}$ .

the stopcock should be opened, when the liquid will drop quickly back to the starting point, to rise again as before when the stopcock is closed, and so on indefinitely. For demonstration of osmotic absorption before a class, this instrument is extremely satisfactory, and, moreover, it may be preserved, ever ready for immediate use, by removing tube and funnel and keeping cup and stopper stored in a bottle of molasses; it is only necessary to place the cup under a tap and wash away the surplus molasses, when it is again ready for immediate use. While this instrument is so good for demonstration to a class, it works far too quickly to be useful for deliberate study by the students in the laboratory, nor does it give any idea of how long the process could go on, or how much water can thus be absorbed. Hence, for laboratory study by the students, it is better to use a form like that of the smaller illustration in Fig. 30. The cup consists simply of a standard "diffusion shell" (SCHLEICHER and SCHUELL) of 16 mm. diameter, sold at a cost of about twenty-five cents by all supply companies; it should be tied tightly, after soaking, to a tube of approximately the same external diameter. If the cup be filled with molasses, the water will enter and the liquid will rise, rapidly at first and then more slowly, for about a week, reaching a height of over a meter; and this forms a rather impressive exhibition of osmotic absorption. Before the experiment is ended, the liquids will ferment, which produces bad odors; but fermentation can be prevented by the addition of two per cent of formaline to both molasses and water. The cup, when washed clean, may be preserved dry and used repeatedly. If one attaches the cup to a short tube, connected by a stopper to a slender tube, the liquid may be sent to a height of several feet.

In this experiment, some of the molasses comes out into the water, as the color will show, and as can be further proven by the application of Fehling's test for sugar, if the teacher thinks it worth while. It is a fact, however, which the student will surmise and the teacher can confirm, that the sugar in roots does not come out into the soil; and thus is shown a difference between the parchment membrane and that of the root hair. This difference is found in the existence of the protoplasmic membrane lining the wall of the root hair, which membrane has the power of permitting the passage of water while preventing the passage of sugar. For this reason such a membrane is called semi-permeable in distinction from membranes like the parchment which is permeable to both substances. It is entirely possible to make semi-permeable membranes artificially, from certain chemicals; and such a membrane can be formed over the inside of the parchment cup, after which no sugar will escape from the cup, and the liquid will rise very much higher. Thus, if the cup, after attachment to the tube, is soaked for twenty-four hours in a three per cent solution of copper sulphate: is emptied and lightly rinsed with water: is filled with a three per cent solution of potassium ferrocyanide (care being used in handling, for it is poisonous): is placed back in the copper sulphate for another twenty-four hours: is emptied and filled with molasses, and stood in water, the semi-permeable membrane is usually efficient. The matter is perhaps too special for introduction into this course; the teacher will find more detailed practical directions on the subject, if he wants them, in my work on Plant Physiology.

The student will probably remark, as a result of his earlier study of sap ascent, that there is another marked difference

between the conditions of these experiments and those of the roots, viz. in the tubes the rising liquid is a mixture of sugar and water, while in the ducts of the plant it is only pure water. And he will probably infer that this difference is connected with the fact that in the tubes there is no break in communication between membrane and tube, while in the roots there is interposed a series of closed cells. In some way, therefore, the sugar is stopped in the cells, allowing only water to pass. The exact physical basis of this is not yet understood, and in fact remains the greatest puzzle in connection with this whole subject of water ascent. But in a general way there is no question that the absorption of water by roots, and of water by an osmoscope, especially if the latter be provided with a semi-permeable membrane, is the same physical process.

#### **XIV. The Structure of Flowers**

54. Study the structure of the Scilla flower.

- (1) Of what distinct parts, visible without dissection, is it made up?
- (2) In what positions relatively to one another are these arranged?
- (3) How much of structure can you see in each?
- (4) What is the structure of the ovary as revealed by sections?

*In addition to drawings, construct a diagram to show in ideal horizontal section the ground plan of the flower, and another to show it in ideal vertical section, using semi-conventional symbols (to be explained), for the*

*structures. In each structure represent the section as passing through the most typical part. The two diagrams are to be complementary to one another, and one need not repeat facts shown by the other.*

55. Study in the method of 54, and diagram, the structure of the Tulip flower.

Can you homologize the parts of this flower (and of the Scilla) with the structures produced by an ordinary bud, in the place of which you have found that flowers originate?

Study the structure of the essential parts of the flower, viz. ovule and pollen.

- I. From thin sections made across the ovary, determine with aid of the microscope, —

(1) What is the structure of the coats and interior of the ovule?

(2) Do you find any parts answering to those in seeds?

(3) What structure has the embryo sac, especially as to any free cells therein?

- II. From pollen placed on a slide, determine, —

(1) What visible structure does the grain exhibit?

(2) What change occurs when water is added?

56. A study of osmotic absorption by roots.

Results of the preceding experiment suggest that if the absorption by roots is osmotic, then water

ought to rise in tubes attached to roots. This is easily tested by experiment (Experiment 11). Relation of such water ascent to "bleeding." Its rise against gravitation suggests that pressure is exerted; our knowledge thereon; possible relation to the causes of sap ascent.

**Materials.** — Other things being equal, it is obviously best to take up the study of flower and fruit at this point, following right after the study of the other plant organs, leaf, stem, root; but an alternative plan, which various considerations, especially as to supply of materials, might justify, would be to begin here the study of the groups, postponing the flower and fruit until they are reached again with the Phanerogams in the late spring. If taken in winter, as here recommended, the common Squill, *Scilla siberica*, is the simplest and most typical plant available. It is easy to raise in shallow boxes; the bulbs, each supplying several flowers, are cheap, and any skilful gardener can have them ready on a given date. Tulips are good, but much more expensive. Next best is Hyacinth, the single white Roman kind, but this is much less simple and typical, and, for beginning, it is best to have a flower with floral parts distinct; and one with superior ovary is indispensable. Hyacinths are grown for sale in most greenhouses, and flower so abundantly they are not expensive. In summer many simple forms may be collected and preserved in formaline, or even dried and pressed, but in the latter case they must be soaked out in warm water, and are far inferior to fresh flowers. It would be a tactical error for any teacher to give a pressed flower to a pupil to



begin with. If the work comes in early summer, the Trillium is one of the best plants to use first, but it may not be as easy to obtain good simple materials in the summer woods as in the winter greenhouse. For the study of pollen and ovules, Hyacinth or Tulip are good. A number of thin sections made right across the young ovary of either are pretty sure to show some good embryo sacs, with an occasional well-displayed egg cell, a good specimen of which can then be requisitioned from its fortunate maker, not at all to his dissatisfaction, for use as a demonstration object for the others.

**Suggestions on Teaching.** — This work is of course intended to introduce the student to the very important subject of floral structure, and the facts thereof must receive first attention. At this stage of their training, the students should be able, without special help, to work out fully and correctly the structure of such a flower as the Scilla, and to represent it well. They should not miss such points as that three of the perianth parts are outside of the other three, that there are three cells to the ovary, that the ovules are on a central placenta, and that the anthers contain pollen. But too much detail, such as kinds of ovules, dehiscence of anthers, etc., must not be expected at this stage, else confusion will result and proportion be destroyed. Terms for the principal parts, — perianth, petals, sepals, etc., — and especially for the conditions of union of parts, — gamopetalous, gamophyllous (for parts of a perianth), etc., — should not be given until the need for them has been felt. The early study of pollen and ovule is extremely important as helping to impress upon students a knowledge of the real essentials in the flower. The construction of the diagrams is the most important pedagogical part of this exercise. They will be spoken of below.

In morphology, especially as called for under Exercise 55, the students should of themselves recognize that receptacle is stem which remains short, and that petals and sepals represent leaves; but the morphology of stamen and pistil, particularly anthers and ovules, will puzzle them. They should be allowed, or, if necessary, led, to see that the latter are not homologous with anything they have yet studied; in fact they are as distinct from leaf or stem as these are from root, and they are older than the leaf or the stem, as discussed on an earlier page (230). They are sporangia containing spores, an inheritance from the non-flowering plants, with certain appendages added. In fact, though of course this is not to be given the students in detail, the ovule (more exactly, its nucellus) is a spore case containing a single spore (megaspore or embryo sac) whose germination produces the egg-cell, the whole being surrounded by one or two protective coats. The anther is a spore case containing spores (microspores or pollen grains), whose germination produces ultimately the pollen tube with its contents. The pistil is composed of infolded leaves with the spore cases on their edges. It is a mistake to try to homologize the ovary, style, and filament, with blade or petiole of a leaf, for the differentiation into blade and petiole is an attribute of the foliage leaf only, not of the spore-bearing leaves, which, it is possible, have not been derived at all from foliage leaves (see p. 230). I have found it in my own experience most profitable to teach the correct morphology of these parts, including ovule and pollen grain, from the start; students understand it as readily as they do the older formal and partly incorrect morphology, and they have nothing to unlearn later.

It is usually assumed that a perianth tube, such as the

Hyacinth exhibits, is composed of united petals and sepals; but this view, as earlier explained (p. 235) is probably incorrect, since the tube does not develop as a result of fusion of the bases of petals and sepals, but as one continuous ring-like structure which carries up the original petals and sepals (*i.e.* the free petal and sepal lobes) at its top. The point is important for an understanding of the composition of complex flowers.

The function of pollen and ovule can best be made plain through an account, fully illustrated by diagrams, of the process of fertilization, and the teacher may convey an item of very valuable knowledge by remarking that this process is identical in its physiological essentials and meaning throughout the animal as well as the vegetable kingdom. The function of calyx is easily shown by reference to buds, where it is obviously a protective wrapping to the young parts. As to the corolla, its function should be stated in a general way; but, in order not to confuse the student by the introduction of too many new matters at once, the discussion of its meaning in detail should be left until later, when, also, more data will be available.

Like most other teachers, I have used blank forms for description of flowers, but, because there are better ways, I have abandoned them. One might suppose that the use of floral diagrams involves some of the same disadvantages, but in practice this does not follow.

Of great value in the study of flowers is the representation of the fundamental facts of their structure by horizontal and vertical diagrams as called for under Exercise 54. These are intended to represent, not superficial features of form, etc., so much as fundamental relations of number, relative

position, coalescence, etc. Ground plans for this purpose are given in all works upon floral structures, but the equally useful vertical plan is much less used. Of course the teacher must give some preliminary suggestions as to their value and the general mode of their construction. As an example, these diagrams are here given for *Scilla* and *Hyacinth* (Figs. 31, 32). The following principles should be observed

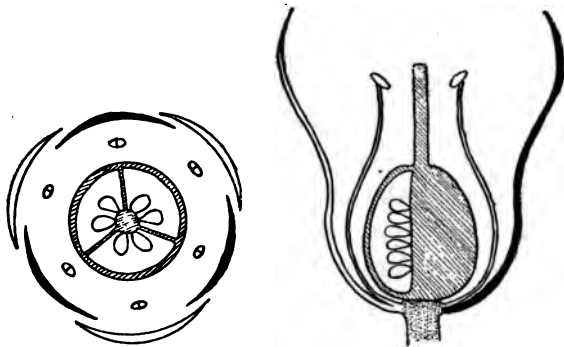

FIG. 31. — Diagrams of *Scilla* Flower. Receptacle dotted; carpels cross-lined; petals black; sepals and stamens unshaded.

in their construction. The two kinds are complementary to one another, and it is not necessary to try to show in one anything already brought out in the other, although such duplication is desirable so far as it does not interfere with clearness. Relations of number, alternation, and coalescence of like parts are brought out in the horizontal, and general form and adnation of unlike parts in the vertical. Somewhat conventionalized forms and shadings, as shown by the accompanying examples, can be used to distinguish the parts; though the students in their work will find it possible, and better, to use colors, as

soft and pleasing as possible, applied by colored pencils. The actual form should be kept in so far as may be possible without interfering with the clearness of representation of the more essential features. The diagrams should be constructed with the most rigid exactness, every spot and line having its meaning, and no confusion of lines should be permitted. Particularly important is the insertion of parts

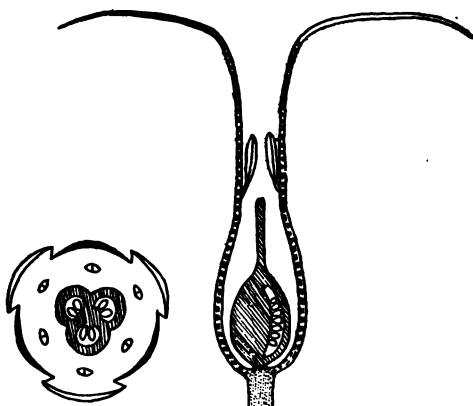

FIG. 32. — Diagram of Hyacinth Flower. The vertical lines show the perianth tube; other shading as in Fig. 31.

upon the receptacle and upon one another; and lines should not be allowed to touch one another in the diagram except in order to represent parts grown together in the flower. The help of compasses, etc., should be allowed, and required, if necessary to make them symmetrical. Teachers should remember, however, that while these diagrams are extremely useful servants, they are bad masters. In my own experience I have found nothing to equal them for compelling clear thinking on the part of the student.

**Physiology.** — The absorption of water by roots, quite independently of any influence exerted by transpiration or other activities of stems and leaves, is easily demonstrated as follows: Select a vigorous well-rooted plant, not yet mature and having a single firm smooth stem (*e.g.* Fuchsia, Marguerite, Horseshoe Geranium, Heliotrope), and cut away the stem about 2 cm. from the ground: over the stump slip a tightly clasping piece of soft rubber tubing which is cut so as to leave 1-2 cm. projecting; into this projecting tube slip a glass tube of approximately the same diameter, and of about 100 cc. capacity, preferably graduated, and make sure that the joints are tight by gripping them with wire if needful. If now the plant is given a sufficiency of water and good temperature, the water will rise to an amount which with some plants may fill the tube, *i.e.* 100 cc. Certain plants, indeed, among them some species of Begonia, will give off much more than this, even approaching 200 cc. in vigorous plants of ordinary potted size. It is worth while to place a little oil on the water in order that none of this may be lost by evaporation. This experiment (which, incidentally, illustrates the nature of the "bleeding" of grapevines when pruned too late in spring, or of trees whose young branches are winter-broken), shows the quantity of water which is exuded, and therefore, in a general way, absorbed by the roots. Its rise against gravitation shows that pressure is exerted, but no idea is given of the power or pressure by which the water is absorbed and forced up stems. The latter matter can be settled by experiment, though the manipulation is not easy. The experiment, commonly figured in the current text-books, making use of a large open pothook-shaped gauge, is entirely value-

less for this purpose, and is perpetuated only because of a confusion in the minds of most persons between the quantity of water sent up stems by roots, and the pressure under which it is forced up. These are, in reality, two totally different phenomena; the quantity may be so small as to push the mercury in one of the aforesaid gauges only a very short distance, which would then be taken to mean a very low pressure, whereas the pressure under which this small quantity is given off may really be very high. The only correct way to measure these pressures, therefore, is to use gauges which will register very high pressures with a very small quantity of water. Best for this purpose are small closed gauges, for whose construction and use full directions are given in my book on Plant Physiology; but they are not very effective for demonstration. Much better for the latter purpose is an open but slender mercury gauge used in connection with a plant known to exude ample water to force the mercury to a point sufficient to register its greatest possible pressure. Such a gauge, which has to be made to order at present, but which will presently be supplied among my

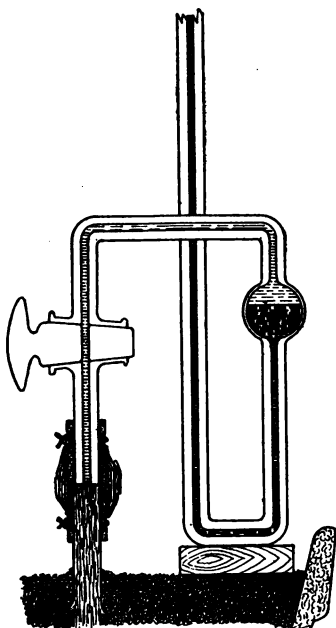

FIG. 33.—Apparatus for the demonstration of Root Pressure;  $\times \frac{1}{2}$ .

normal apparatus (mentioned on p. 134), is shown by the accompanying figure, Fig. 33. It is of glass barometer tubing, 8 mm. external and 2 mm. internal bore, with a mercury reservoir bulb and stopcock as shown by the figure, and a main tube over 30 inches long. The stopcock is added, partly to prevent danger of jarring the mercury out of the short tube during handling, and partly to prevent evaporation of the water above the mercury when the instrument is not in use, for it is somewhat troublesome to fill this part in a way to exclude air. The filling, by the way, is accomplished by tipping the tube and jarring the mercury while the short tube is immersed in water boiled to free it of air. The plants best adapted to this experiment are Fuchsia, Marguerite, Horseshoe Geranium; and the quantities, both of exudation and pressure, which they yield, have been determined and are stated, along with the data for many other plants and with other particulars concerning this experiment, by SOPHIA ECKERSON, in the *Botanical Gazette*, 45, 1908, 50. The short tube, first filled with water, is attached to the cut stump of the plant by tight rubber tubing, which is then wired firmly to tube and plant and enwrapped by several turns of electrician's (or tire) tape to make a pressure-tight joint, as shown diagrammatically in the figure. Then the stopcock is opened, and the rising water will slowly force up the mercury until its weight balances the pressure. Then the difference in level of the mercury in reservoir and tube shows the pressure expressed in fractions of an atmosphere, which of course is approximately 15 pounds to 30 inches of height. Some common greenhouse plants, as Miss ECKERSON'S experiments have shown, give an atmosphere, or over, of pressure.



**XV. The Morphology of Flowers**

57. Study the structure, comparatively, of a series of flowers of progressively increasing complexity of structure, *e.g.* Hyacinth, Snowdrop, Narcissus, Primrose, Fuchsia, Cineraria, and express their composition in the horizontal and vertical diagrams.
58. Study in like manner, and diagram, two or three irregular flowers, *e.g.* Cytisus, or Chorizema.
59. Construct a series of diagrams, using colors, to show the intermediate stages in the development from a simple conical vegetative point of —
  - a.* A flower with all parts distinct.
  - b.* A flower with superior ovary, but the other parts standing on a tube.
  - c.* A flower with inferior ovary, but other parts distinct.
  - d.* A flower with inferior ovary, but other parts standing on a tube.
60. Study a series of a dozen specialized flowers, and determine the morphological identity of each part.
61. A study of common osmotic phenomena.

The facts as to osmotic movement between liquids of different densities, and osmotic pressures which can be exerted; relation of osmotic pressure to turgidity and the maintenance of form in the plant: other common osmotic phenomena.

**Materials.** — The flowers named in Exercise 57 are all obtainable at moderate cost from commercial greenhouses in late winter, and with little trouble may be forced in one's own greenhouses so as to be ready at any desired date. They represent a series showing progressively increasing complexity of the flower up to the most specialized condition of all, and it is worth while to take considerable trouble to obtain them. The irregular flowers of Exercise 58, found in all greenhouses, are less important, and are introduced chiefly as a study in the diagramming of irregular kinds. Exercise 60 is valuable for a comprehensive view of the range of morphological modification in the parts of the flower and for practice in the recognition thereof; admirable material is furnished by specialized flowers present in any greenhouse — Begonia, Calla, Orchids, Poinsettia, etc. As they need not be dissected, or only partially, a few will supply many students. And of course museum material and pictures are available as supplementary illustration.

**Suggestions on Teaching.** — This work leads the student from the structure of flowers to a consideration of their comparative morphology. The question of the morphological composition of the wall of the inferior ovary must be faced. Students may best be introduced thereto by stating to them the fact, illustrated by diagrams, that every flower, no matter how specialized, originates as a set of originally distinct leaves on a conical receptacle; let them reason from this in the case of the Snowdrop, and if they are not previously prejudiced by the calyx-adnate-to-the-ovary theory, they will readily see that the stamens, petals, and sepals must stand on the receptacle, which therefore must form the wall of the ovary by growing up in the form of a hollow cup,

while the carpels form the roof over it, as well as the partitions. This is the morphology which embryology sustains, although some students consider that the carpels continue to line the hollow receptacle throughout. The fact, however, probably is that in such highly specialized ovaries, the old distinctness between carpel and receptacle has been lost, — merged into the new morphological unit, ovary. In the *Fuchsia* the morphology of the ovary is the same, but here, in addition, a tube is formed after the manner already mentioned for the *Hyacinth* and *Primrose*. In the composite flower the morphology is very like that of *Narcissus* and *Fuchsia*, *i.e.* the ovary is a hollowed-out receptacle on the top of which stand the sepals (often finely divided into a pappus) and the corolla tube.

In diagramming these more complicated flowers, it is more needful than before to use shading or coloring consistently for the different parts; and a uniform system, to be replaced by colors in class work, is shown in the accompanying figures (Figs. 31, 32, 34). In diagramming the irregular flowers, as the *Cytisus*, a part of the irregularity can be shown, but it must never be allowed to interfere with the clearness of the ground plans. Models for the horizontal diagrams of such flowers are contained in LE MAOUT and DECAISNE'S *General System of Botany* and in EICHLER'S *Blütendiagramme* (of which a translation is announced as soon to appear from the Clarendon Press).

Along with the study of the flowers used in these exercises the teacher should begin to call attention to features connected with cross pollination, *e.g.* the great nectar glands of *Fuchsia*, and he may use these matters to arouse curiosity, or at all events excite interest, preparatory to the more definite study of the subject to come later.

One of the most valuable of all morphological studies is that involved in Exercise 59. It cannot, it is true, be worked out from observation, but must be developed theoretically,

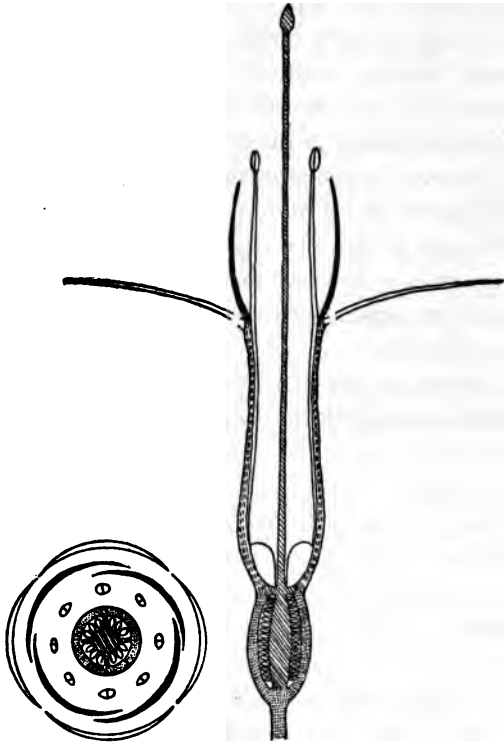

FIG. 34. — Diagrams of Fuchsia Flower. Shading as in Figs. 31 and 32.

The sepals are disconnected in order to show that they are in a different plane.

with aid of considerable explanation from the teacher, along the lines indicated by the accompanying diagrams (Fig. 35). All flowers originate in the bud in substantially the same way, and these diagrams show the development, through

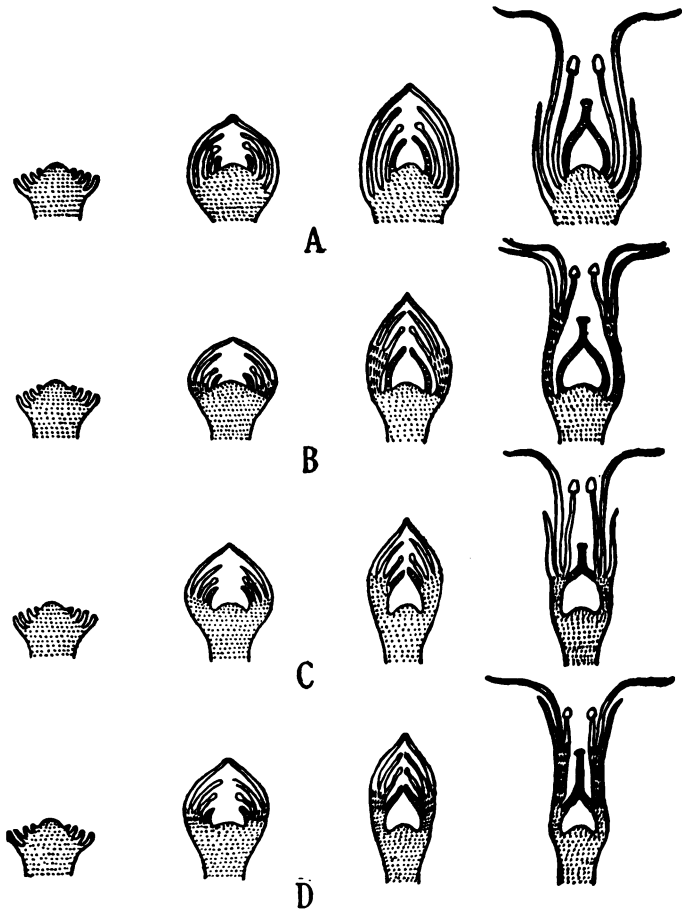

FIG. 35.—Diagrams to illustrate the development of typical Flowers. *A*, hypogynous; *B*, perigynous; *C*, epigynous; *D*, epigynous with prolonged "calyx tube." Receptacle is dotted; carpels are cross-lined; "perianth tube," or "calyx tube," vertically lined. Sepals, petals, and stamens are unshaded, but may be distinguished by their relative positions.

two intermediate stages, of the four types from similar buds. In order, however, not to interfere with the clearness of the developmental idea, the calyx and corolla are represented alike on the two sides of the diagram, though they are rarely thus symmetrical in the actual flowers. This exercise requires use of the visualizing imagination to the extent of almost mathematical clearness. A student cannot construct these diagrams who does not really understand the morphology of the complex flowers. Series *A* is about like the Scilla, except that it is supposed to have calyx and corolla unlike one another; *B* is not like any of the flowers studied, but is nearest like the Hyacinth except for the different appearance of calyx and corolla; *C* is like the Snowdrop, and *D* like the Fuchsia. This morphology differs much from that found in the older books and retained in works on taxonomy, but is more nearly correct, as shown by embryological studies.

**Physiology.** — It is of importance and interest to apply the knowledge of osmotic processes gained by the preceding experiments to the explanation of some common phenomena. Of these the most striking is the maintenance of turgidity by osmotic absorption into soft cells, to which is due the stiffness which young leaves, stems, etc., present. The osmotic basis of this stiffness can readily be proven by a simple experiment as follows. Soak a piece of parchment-paper tubing, some 15 cm. long, for a few minutes in water, and tie one end to a stoppered tube (*e.g.* upper half of a vial) and the other to a small stopcock. Through the vial, nearly fill the tube with a mixture of half molasses half water, and insert the stopper very tightly; then open the stopcock and release all air, after which it is to be closed. The tube should

now be supported by the middle on a piece of tape, from which it should hang limply as shown in the lower part of the accompanying figure (Fig. 36). If now it be suspended in a glass dish of clear lukewarm water, it will, within an hour, stiffen out as shown by the upper part of the figure, while its state of tense rigidity may be tested, in part by feeling the parchment, and in part by the result of opening

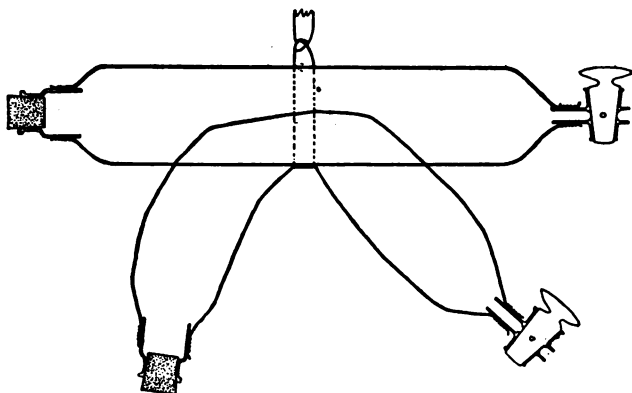

FIG. 36. — Arrangement for demonstration of Osmotic Turgescence;  $\times \frac{1}{2}$ .

the stopcock. It may of course be used repeatedly, the pressure being relieved through the stopcock, until the molasses has become very weak, and it may be kept stored in a bottle of molasses always ready for new use. The experiment, however, is one for demonstration rather than detailed study. This experiment shows the turgidity that can result from osmotic pressure: the correlative fact, that a reduction of osmotic pressure destroys turgidity, can be proven for young leaves or stems simply by immersing them for a time in any solution of a strength markedly greater

than that of their own sap, such, *e.g.*, as a solution of common salt, of about ten per cent strength. When collapsed by the treatment, they may often be restored by immersion again in pure water.

Another experiment of much interest in this connection, hardly adapted, however, for general class use, is that showing plasmolysis of cells (that is, the shrinking of their protoplasmic membranes away from the cell walls when immersed in solutions stronger than the cell sap), for which directions are given in the practical works.

Other osmotic phenomena of importance are the bursting or collapsing, respectively, of berries cooked with much or little sugar; the plumpness of cooked currants or raisins in comparison with their collapsed condition when dry: the swelling of soaked seeds, powerful enough to burst bottles or lift heavy weights (though this swelling at first is not wholly osmotic): the preserving power of strong solutions of sugar (which is not poisonous to germs but withdraws water, preventing their growth): while the power of delicate roots, or some kinds of Fungi, to penetrate hard soil and even to burst pavements or lift stones is due to the same power.

The exact physical basis of osmotic pressure is not yet certainly known, but the simplest explanation, and one quite as likely as any other to be correct, is that it rests on a powerful adhesive attraction between the dissolved substance and water, sufficient to permit the substance to draw the water away from the membrane, which itself powerfully absorbs a new supply from outside. The membrane acts chiefly as a kind of sieve, permitting the water molecules to pass somewhat freely between its own molecules, or other elements of which it is made up, while rendering difficult the passage of



the much larger sugar molecules; and when the membrane is semi-permeable it renders this passage impossible. This explanation, it is true, is a conventional rather than a strictly physical one; but the elaborate physical study of the process is out of place in this course.

### XVI. The Ecology of Flowers

62. Study the various flowers accessible, and note their features of form, size, color, shape, and special mechanical arrangements, in relation to probable or possible methods of cross pollination.

63. Study the flower clusters, and determine, —

- (1) In what positions do the younger flowers stand, relatively to the older?

*Invent suitable diagrams for representing these arrangements.*

- (2) Can you trace any connection between the size of a cluster, and the size or number of blossoms composing it?

- (3) What probable adaptations to cross pollination can you find in the construction of the clusters?

64. A study of plant growth.

General phenomena of growth in plants: two phases, — increase in size, and formation of new parts; position of most active growth in roots, stems, and leaves. Known fluctuations in growth; these pre-

sumably connected with alterations of external conditions, which may be tested by observation of a continuous record obtainable by experiment (Experiment 12).

Formation of a growth graph: effects upon growth of fluctuations of temperature, humidity, light; growth movements, including circumnutation.

**Materials.** — These, of course, can consist usually of such flowers as are available in greenhouses (including those used for study in the two preceding sections), supplemented by some museum material and the abundant good pictures available in books. The important works on the subject are mentioned in an earlier chapter (p. 190).

**Suggestions on Teaching.** — In principle this work on cross pollination belongs to summer field studies and is of little profit when made only upon greenhouse plants, which are removed wholly from their natural surroundings and from their pollinating insects. Yet in fact, because of practical difficulties, even extensive field work yields a very limited knowledge of the subject, and in any case a comprehensive view thereof must be chiefly theoretical. Hence it is well worth while to consider the subject in a general way from greenhouse materials, supplemented by museum material and especially by good pictures. Moreover, with some flowers, a good deal of simple but illuminating experiment is possible in proving the operation of the mechanisms, by imitating the action of the insect through use of pencils, brushes, etc. The subject should be broadened to include a study of cross pollination by the agency of wind, water,

birds, and other animals. The entire subject is one of very great interest to most students, and well worth a good deal of attention.

As to the facts of the transport of pollen by insects and other agencies, and the necessity thereof to many plants in securing fertilization, there is, of course, no question; but we are not at present so sure as we were as to its ecological significance. The older, or conventional, argument ran somewhat thus: Experiments and observation have shown that better seed is produced when pollen and ovule come from different plants; this requires the transport, by some external moving agency, of pollen from one plant to another; this is often brought about by wind, but that is a very wasteful method; a much more economical method would consist in the utilization of some agency which could be made to move in a definite path from one flower to another; small animals, particularly insects, form such an agency, but some inducement must be provided to make them visit the flowers; this is generally effected by the provision of nectar, on which they feed; but the place where nectar occurs must be shown the insects so they may find it; this is accomplished either by strong odors, or else by color, usually developed in a special part, the corolla. Then the argument may be continued thus: not only must the insect be brought to the vicinity of the nectar, and therefore of the pollen, but it must be made to approach the nectar in such a way as to leave upon the stigma the pollen it has brought, and to take a new supply; hence the different shapes and sizes of flowers — shape being an adaptation to oblige the insect to enter the flower in a position suitable to insure the pollination, and size being in general related to the size and form of the visiting insect.

This mode of reasoning must be used with great caution, and not allowed by the pupils without the accompaniment of a full statement of its purely theoretical nature.

The work on flower clusters should include some terminology, as well as the simple diagramming of the more prominent kinds of clusters. The subject is admirably treated in the works of ASA GRAY. Ecologically it includes nothing of special interest, the massing of flowers in clusters being apparently an accessory adaptation to making them more conspicuous to insects.

**Physiology.** — The physiological study of growth could logically well come earlier, *e.g.* in connection with the study of the developing plant, or with respiration, but there is a great practical advantage in postponing it to this time, *viz.* it brings the study in the early spring when all conditions for growth itself, and for a supply of the best materials for its demonstration, are far more favorable than they can be earlier in the year. It is particularly difficult to demonstrate it before the "turn of the year" (in autumn and early winter), because most plants are then passing into a resting condition. Growth is one of the most important but most complicated of physiological processes. The teacher should as usual lead up to the subject along some discussion of familiar facts, perhaps somewhat as indicated under Exercise 64. The place of most active growth in roots, stems, and leaves is easily determined experimentally as follows: Germinate some Beans or Corn in Sphagnum moss, until the roots are 2 cm. long; withdraw a seed, lay the root flat on the moss and mark it, by waterproof India ink, with regularly-spaced marks 2 mm. apart from the tip backward; then place it in a clean thistle tube, the seed in the bulb

packed with moss and the marked root in the tube; stand the tube in a dark warm place, tipped slightly away from the marked side of the root, which will then exhibit the place of its growth by the new spacing of the marks. Young stems and petioles may be marked in the same way, but need no special treatment; while leaves for the same purposes may be marked into regular small squares, the spread of which will indicate the place of principal growth. The marking can be done by small brushes or inked threads, but special space markers, adjusted to mark roots, stems, and leaves very rapidly and efficiently, are supplied with directions for use among my normal apparatus (mentioned on p. 135). These experiments can well be shown in demonstration, though I have not included them in the regular series for student study.

Preparatory to the further experimental study of growth, the teacher should recall some of the familiar facts about the fluctuations of plant growth, and especially the well-known facts that its rate is greatly affected by warmth, cold, dampness, light, and darkness, etc., and he should lead the students to desire some more exact study of the subject. This necessitates some kind of continuous record of growth which will permit its fluctuations to be compared with those of external conditions. Such a record can be obtained only by some form of recording auxanometer or auxograph, of which a good many forms have been described, all summarized in my book on Plant Physiology. A very efficient form, adapted especially to demonstration work, has recently been added to my normal apparatus, and is shown in the accompanying figure (Fig. 37). In setting up this instrument for use, the two support rods are first to be screwed

firmly into the support stand in the positions shown by the figure. The wheel arm is then placed on top of the longer



FIG. 37.—Demonstration Auxograph;  $\times \frac{1}{2}$ .

rod and tightened in place by the screw, the wheels are dropped into position, and the guide wire for the pen carrier is stretched from its ring on the clockwork to its screw clamp on the wheel arm. A paper, preferably a smooth millimeter

cross-section paper, is then placed on the recording cylinder. The paper clings closely if simply tightly appressed with one edge slightly overlapping and tightly gummed on, the overlapping being so managed that the pen cannot catch on the projecting margin. The cylinder is then placed on the clockwork, which is adjusted at such height that the cylinder is held at the top by the screw there provided. The glass pen is then filled with chronograph (slow-drying) ink, which is drawn in through its point by suction on a slender rubber tube; and it is slipped into the flexible carrier which is guided on the slender guide wire. From the pen carrier a very slender, carefully but flexibly waxed thread is carried over the pulley wheel and the outer groove of the quadruple magnifying wheel, where it is passed out through a tiny hole provided for the purpose and fastened by a knot, this thread being just long enough to allow the pen carrier to reach the bottom of the cylinder while leaving a centimeter or two still on the rim of the large wheel. This wheel is then turned to draw up the pen carrier to the top of the cylinder, and is then held fixed in that position by the special clamp provided for the purpose. A potted plant, preferably one with a main stem just beginning active growth, is then placed on the plant support, which is attached to the shorter support rod and adjusted at such height that the tip of the growing stem is about 4 cm. under the larger wheel. A thread, treated as in the former case, is then tied in a loose-fitting loop just under the terminal bud, and is carried up a little way, over the smallest of the quadruple wheels (for great magnification of the record, — over one of the others for a lesser) and is pushed out through a hole and knotted as in the other case. Then the support stand should be leveled

by the screws provided for the purpose and the clock should be wound; then the clamp is released from the large wheel, when the tensions of the threads will adjust themselves, and the record will begin. The weight of the pen and carrier is such that it just suffices to turn the wheels smoothly as the growth of the plant permits this to be done; and the pen descends steadily and traces on the turning cylinder a spiral line which crosses the vertical line through the starting point once an hour. Thus the growth of the plant is automatically marked off on this line every hour, magnified of course exactly in the proportion of the diameters of the two wheels concerned (*e.g.* 8 times when the smallest wheel is used). The diameter of this cylinder is such that if a millimeter paper be used, each millimeter space answers to a minute of turning. Once daily, preferably always at the same hour, the clock should be wound (which of course is done from beneath without disturbing the record), and the plant should be watered, while, as often as needed, a new paper should be placed on the cylinder and the plant readjusted. This is effected by, *first*, turning the large wheel until the pen carrier is drawn to the top of the cylinder; *second*, clamping it in that position; *third*, cautiously lowering the entire plant support until the thread from the tip of the plant becomes just taut once more; *fourth*, releasing the clamp to allow the tensions to adjust themselves and the record once more to begin. One should by no means draw up the pen carrier by simply lowering the plant support, for, although this perfectly and accurately effects that end, it brings a severe and injurious strain to bear upon the slender growing tissues of the tip. By the use of the movable plant support, it is never necessary to touch the threads themselves during the entire course



of the experiment. The spiral line of the record should be fine (though plain enough to be seen from a considerable distance) and should be quite smooth: if jerks appear, it means either that the axles of the wheels are not moving freely (when they should be cleaned and oiled), or else that the thread is too stiff and tends to set on the small wheel, or else that the pen carrier is not quite heavy enough to turn the wheels freely, in which case a little loop of wire can be hung upon it, though no more such weight should be used than just suffices to turn the wheels.

Some emphasis has been given above to keeping the threads as short as will suffice for their work. The reason is that all known threads, no matter how carefully waterproofed, will absorb moisture from the air and alter their lengths, thus introducing into the records an error which obviously is the less the shorter the threads. The greatest error is introduced by the short thread, because any alteration in its length becomes magnified eight times in the record; and it is possible that the greater part of its length could be replaced by a fine glass filament, leaving only the loop around the plant, and the part around the wheel, to remain of thread. This error from the thread can also be relatively reduced by using plants of the most rapid growth, which, for demonstration purposes, is obviously desirable for other reasons also. Best of all plant parts for the purpose, and available at the time of the year this work is most likely to come, are the developing flower stalks of bulbous plants forced in spring in a greenhouse, and of these Grape Hyacinth is one of the best. From the flower stalk of this plant one can obtain, on such an auxograph as here described, a continuous record which will be completed within two weeks, and will

show the grand period of growth, with fluctuations due to temperature and other causes. Contemporaneous observation of the external conditions, especially of temperature, will show the effects of these upon growth; or, the entire instrument can be exposed for a time in places where these conditions are especially high or low.

If the papers, removed from the cylinders, are opened and attached end to end on a board, they will present an admirable record of growth, suitable for permanent preservation. But the record may also be expressed by a graph, in which the horizontal line is marked off into divisions to correspond to the time, and vertical lines represent the amount of growth per hour, when the joining of the tops of these vertical lines will give a "curve," very expressive, in its rise and fall, of the fluctuations of the rate of growth.

The subject of growth movements is a large one, and probably the only movement which the teacher will care to emphasize is circumnutation, which should be described, if not demonstrated, because of its interest as a piece of knowledge about plants. The experimental demonstration is not difficult, following Darwin's classical method, which has not yet been improved upon, — viz. the use of glass filaments attached to the tips of the circumnutating parts and sighted through sheets of glass upon which record marks are made.

Some consideration should of course be given to the subject of the effects of light and moisture, as well as temperature, upon growth, with comments upon their economic correlations. Upon these matters some simple experiments are possible, directions for which are given in BERGEN'S or OSTERHOUT'S books, or in my own work on Plant Physiology. The subject of differentiation, or formation of new

parts, is also of much interest, but in detail is too special for introduction here.

### **XVII. The Morphology and Ecology of Fruits**

65. Study the structure and morphological composition of six important dry fruits.

- (1) What has become of each of the parts of the original flower, *i.e.* sepals, petals, stamens, receptacle, ovary, style, and stigma?
- (2) How are the carpels or receptacle modified and arranged to form this fruit?
- (3) What is the morphological origin of the new or accessory parts not present in the flower?
- (4) In what places, morphologically, is the dehiscence?
- (5) How are the seeds probably scattered?

*Answer as far as possible by diagrams and drawings. Under (2) express the leaf or stem homology in each case.*

66. Study the structure and morphological composition of six important fleshy fruits, and determine the matters of importance as in the preceding exercise.

67. A study of the adjustment of individual plants to their immediate surroundings (Irritability).

The characteristic inherited forms of plants, and the ways in which these may be altered in individuals (*a*) by mechanical accidents, (*b*) by more or less favorable general influences, (*c*) by self-adjustments to irregularities in the surroundings. The best-known examples of the latter are found in responses to direction of light, gravitation, and soil moisture, all of which may be tested experimentally (Experiments 13, 14, 15).

**Materials.** — The dry fruits must be collected the year before, or taken from the museum collection. Typical follicles are Columbine and Larkspur or Monkshood; legumes are Beans or Peas or Locust pods; winged fruits are Maple and Elm; other good forms are Poppy, Sunflower or other composite, Shepherd's Purse. The fleshy fruits can mostly be bought at small cost in the markets. Good kinds are Grape, Tomato, and Orange (especially navel), Apple, Banana, Cherry (canned are good), Strawberry, Cranberry. Many others can be used, but these are particularly typical and easily obtainable. This subject as regards both materials and matter has connection with the earlier study of Ecology of Seeds.

**Suggestions on Teaching.** — The morphological part of this work is rendered difficult by the impracticability of providing the intermediate stages between flower and fruit, without which it is impossible to trace most morphological features with any certainty. It would be a great advantage if some one kind, *e.g.* Apple, could thus be shown in all stages in actual material; and in any case the teacher must

give much aid in this part of the work. Pictures of the flowers from which the fruits develop should be very helpful. The subject will also be simplified if the fruits are studied in order of their increasing complexity. Even though students cannot attain to certainty in the morphology, it will be a most valuable exercise for them to form their hypotheses, and then have these confirmed or otherwise by the teacher, who will supply missing data. Such theorizing, under rigid control, is a truly scientific procedure, — indeed the greatest help of the investigator. There is a particularly good treatment of this entire subject of fruits in GRAY'S Text-books.

It is not worth while to give students unusual terms, such as sarcocarp, etc., but follicle, legume, drupe, etc., should, of course, be supplied as they are needed.

The true morphology of the fruit should be taught; *e.g.* in the Apple, the flesh is mainly receptacle, with a little of it from carpel; in the Cranberry, it is receptacle, etc. It is particularly important for the student to obtain a clear idea of those fruits in which the ripened parts do not follow exactly the morphological boundaries of the floral parts. Thus in the Cherry a part of the carpel forms stone and the other part pulp. Something similar to this separation occurs in the Orange, where the skin is separable; it is a part of the carpels. The pulp of the Orange is a growth of hairs from the inner (upper) faces of the carpellary leaves, though these hairs are not unicellular. The whole subject of the morphology of the pulp, which originates in a variety of ways, is of great interest.

So far as the ecology of fruits is concerned, that is bound up with seed dissemination, a subject which has already been considered but which should here be reviewed with

more detail. Here also the teacher should discuss the economics of fruits, especially in relation to their use as food by man.

**Physiology.** — The study of the adjustments of individual plants to their surroundings by aid of movements which they make for themselves (known as Irritability) is one of the most important parts of Plant Physiology and should receive some attention, although only its more obvious phases are in place in a general course. There are different places in the course where it can advantageously be introduced (*e.g.* phototropism with leaves, geotropism with roots and stems, hydrotropism with roots); but it is also a suitable subject with which to close the physiological work. Of all the responses, the most common and easy to study is that to light (phototropism or heliotropism). It is familiar to everybody in the turning of house plants towards windows. It is worth while, however, to experiment with this power, partly in order to give more exact knowledge thereof, and partly because it is so typical an example of irritability. It can be very effectively demonstrated thus. Provide a phototropic demonstration chamber made from a box divided by a partition into two chambers, each 20 cm. square and 40 cm. high, but both open in the same direction on the same side. It should be painted white outside and black inside, and be provided with a convenient handle on top. Into one chamber is placed a young actively growing plant of slender parts (such as Garden Nasturtium), while in the other a similar plant is placed on a clinostat constantly revolving. If the chamber is then stood in a good light, after some twenty-four hours the plant which is fixed (and which should be stood on a block to bring it to the height of the other on

the clinostat) will be found turned over strongly to the light, while that on the clinostat remains upright and symmetrical, the contrast between the two being very striking. This method also permits, by suitable experimenting, the time needed for the bending towards light to be determined. If no clinostat is available, I presume the same result could be obtained by frequently turning one of the plants during the day time. A clinostat is a very useful instrument, not only for the study of this, but also of other forms of irritability as well. A good form, manufactured for this purpose, is shown by the accompanying figure (Fig. 38); it is supplied among the new normal apparatus mentioned on an earlier page (135). It may also be used in horizontal or



FIG. 38. — Demonstration Clinostat;  $\times \frac{1}{2}$ .

other positions, and to this end is supplied with the needful accessories. Much other easy experimentation upon phototropism, of which the details are all given in books devoted

to the subject, is possible, including the demonstration of the turning of roots from light; but presumably there is not time or need for more of such work in this course.

The adjustment of plants to gravitation (geotropism) is one of the most important of the physiological phenomena they exhibit, and one of the easiest for study, though its very existence is not generally recognized. The students have already come into contact therewith, and in a way which is the easiest of all for its experimental demonstration, in Exercise 14, which shows that all primary roots turn vertically downward no matter in what position the seed first sends them forth. The teacher can also recall to the students another manifestation of geotropism which will be known to some of them at least, viz. the way in which young spruces or firs, standing on hillsides, send their stems vertically upward and their branches horizontally outwards, no matter how steep the slopes may be, thus showing that these positions are determined not by relation to the surface of the ground, but to an up-and-down line which is established solely by gravitation. Geotropism is easily demonstrated in a variety of ways, one of the simplest being that already mentioned, viz. the planting of seeds in as many different positions as possible against the glass of a germination box. The demonstration is still more striking if the seeds are placed in a moist-chamber of glass through which their growth can be observed in all parts. They will grow well if pinned to corks arranged upon the rim of a tumbler, the seeds being kept wet by wicks from the water, as shown by the accompanying figure (Fig. 39). The chamber should be kept darkened except during observation, and the plants will grow better if the old air is occasionally puffed gently out.



Very striking and satisfactory, also, is the correlative experiment of revolving a similar set of seeds upon a clinostat; this is readily accomplished by placing the corks upon the rim of the disk supplied with the instrument. The clinostat is then placed horizontally, with the vertically-revolving disk in a moist-chamber (readily made from a large flower pot bored to receive the rod which carries the disk), just over a dish of water

into which the bits of wicking dip at each revolution. In such case there is no constant position taken by the new roots, but, unless disturbed by some extraneous cause, these continue to grow on straight in the directions in which they start out. Suggestions for performing this experiment in other ways suitable for demonstration, including a method for keeping both

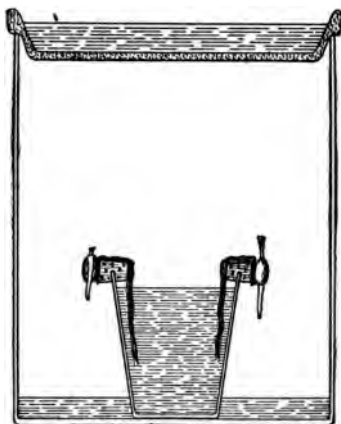

FIG. 39. — Glass moist-chamber for study of Geotropism;  $\times \frac{1}{2}$ .

sets of seeds under conditions almost exactly identical while upon a single support, are given in my work on Plant Physiology, together with experiments showing many other phases of this interesting subject. Among the most important of these accessory experiments would be one which proves that the movement in geotropism as in phototropism is not a movement of already formed parts, like the movement of a muscle, but is the result of a more rapid growth upon one side than the other of a growing structure; and this is the nature of the

machinery which produces most irritable responses. A point in this process needing emphasis is the fact that responses to gravitation take place not simply towards it, but with equal ease away from it, or horizontally, or at any intermediate angle. This shows that it is not necessary to suppose that roots are pulled by gravitation into their positions, because gravity obviously cannot push the main stems and side branches into their positions. In fact gravitation, in the latter cases at least, and hence presumably in the former, can act only as a pointer or guide to direction, so to speak, the special plant growth being the physical power which sends the part into the new position. This illustration shows well the real nature of irritability — the external influence, whatever it is, acts simply as a signal, but does not supply any power to cause the response. The responding is done by the plant, from its own power, and is made in directions which carry the parts into those positions where they can carry on their distinctive functions to best advantage.

The responses of roots to moisture (hydrotropism) constitute one of their most important peculiarities, though a corresponding power is lacking in stems. A familiar example is found in the well-known fact that the roots of trees often enter and block up drains long distances from the tree itself. The power of roots to follow moisture is readily demonstrated by attaching small seeds (*e.g.* Mustard) against the outside of flower pots stoppered in the bottom and filled with water. The geotropism of the developing roots would naturally tend to make them grow straight downwards, and therefore away from the pots; and this they actually do if the pot is kept tightly inclosed in a chamber in which the air becomes saturated with moisture. But if the pot be

only partially inclosed (it must be covered somewhat or the roots will dry up), the roots will keep close against the moist pot even if this be tilted a good way over from its natural position. There are other ways of demonstrating the same thing, but none that are simpler than this.

The three forms of irritability, here recommended for study, viz. phototropism, geotropism, and hydrotropism, are the most important of its forms, and serve well to illustrate its nature. On this basis, however, the teacher can advantageously give some account of the other prominent forms, especially thigmotropism, with its remarkable manifestations in the curling of tendrils and the movements of sensitive plants, and chemotropism, with its guidance of pollen tubes and antherozoids. Then the characteristics of all forms of irritability in common should be considered, involving the facts that the responses are all accomplished by the plant itself (the external influence or force acting simply as a signal or stimulus) and that they are all adaptive, bringing the parts into positions for better performance of their functions. Thus they all represent methods by which individual plants can fit themselves better to the irregularly distributed conditions of their own individual environments. Of course, the extent to which they can do this is limited. Each plant has its principal features and its ground form imposed upon it by heredity, but in all of its parts it has a certain margin of power of individual adjustment of details. Animals have also some of this power, but in much less degree than plants.

## DIVISION II

### THE NATURAL HISTORY AND CLASSIFICATION OF THE GROUPS OF PLANTS

#### I. The Algæ

##### A. *The Green Algæ, or Chlorophyceæ*

68. Study the *Pleurococcus* (*P. viridis*).

- (1) Describe its appearance, habitat, and mode of nutrition.
- (2) What is the anatomy of its vegetative structure? Is the chlorophyl in distinct plastids?
- (3) What are the stages concerned in its mode of reproduction by fission? What connection can you trace between this and the mode of grouping of the cells?

*Answer, as earlier, by drawings or words as may be most expressive.*

69. Study the *Vaucheria* (*V. sessilis*).

- (1) Describe its appearance, habitat, and mode of nutrition.
- (2) What is the anatomy of its vegetative structure? Are the filaments divided off

by cell walls? What shapes and positions have the chloroplasts?

- (3) What are the structures and stages concerned in its modes of reproduction:—
  - (a) Asexually by motile zoöspores formed in swollen ends of the filaments?
  - (b) Sexually, by fusion of male and female gametes developed in oögonia and antheridia formed as branches from the filaments?

#### B. *The Brown Algæ, or Phæophyceæ*

##### 70. Study the Rockweed (*Fucus vesiculosus*).

- (1) Describe its appearance, habitat, and mode of nutrition, noting especially its mode of attachment to rocks, the use of the bladders, and the way in which it obtains air.
- (2) What is the structure and anatomy of the vegetative body (thallus)? Are the cells differentiated into distinct tissues? Is the brown color in plastids?
- (3) What are the structures and stages concerned in its mode of reproduction by formation of eggs in oögonia and spermatozoids in antheridia, both in conceptacles, and their subsequent fusion outside?

C. *The Red Alga, or Rhodophyceæ*71. Study the Polysiphonia (*P. fastigiata*).

- (1) Describe its appearance, habitat, and mode of nutrition, noting especially the nature of its peculiar relation to Ascophyllum.
- (2) What is the general structure and anatomy of the thallus? Do you find chlorophyll or other color-carrying bodies (chromatophores)? Can you think of a reason for the characteristic color?
- (3) What are the structures and stages concerned in its mode of reproduction:—
  - (a) Asexually by tetraspores developed in the tissue of the thallus?
  - (b) Sexually, by union of spermatia, formed in antheridial branches, with the contents of a procarp seated on the thallus, through a projecting thread (trichogyne), resulting in formation of a many-spored cystocarp?

**Materials.** — Algæ, although amply abundant, are not always easy to collect in condition for study, especially in winter, and those here recommended seem to embody the optimum between importance and availability. It is, of course, desirable that any forms selected shall represent the three great leading subdivisions of the Algæ. For a unicellular form *Pleurococcus* is good and easily obtainable.

It may be found on the bark of trees, on the damp, shaded side, where, forming a green film, it is sufficiently familiar. *Vaucheria* is a particularly good form for study. It occurs on the damp soil of the pots in all greenhouses, but in especial abundance, I am told, in Carnation houses. If some of the soil showing traces of a dark green growth be taken from these pots and placed in shallow seed pans (a kind of low flower pots); and if these are then kept covered by glass plates or bell-jars while well watered and well lighted (though not by direct sunlight), the *Vaucheria* will develop in abundance, and within three or four weeks is in good vegetative condition. In order, however, to make it form oögonia and antheridia, as well as the zoöspores, it is necessary to partially dry out the living material, which is usually accomplished by gradually removing the plate through three or four days. *Spirogyra* is a classic object, and in many respects is good, though it is less typical than *Vaucheria*. Conjugating and zygosporic material must be secured the autumn before (or may be bought from a botanical supply company), and, with vegetative material, may be preserved in formaline. But it can be kept alive all winter in a dish or tank in a greenhouse, and can then be studied in its natural color and appearance, though under these conditions it will not fruit. *Fucus* may be collected on the coast in summer and preserved in formaline, or may be obtained alive and fresh at any time of year from the CAMBRIDGE BOTANICAL SUPPLY COMPANY on a few days' notice. For its proper study sections through the conceptacles are needful, and these may be made by the students themselves with a sharp scalpel, the end of the frond being held between two flat pieces of pith. The sections should be cut dry and placed

under the cover glass before water is added, as otherwise they will curl badly. There is no typical Red Alga which is easily obtainable alive in quantity and in condition to show its reproductive parts to students, but the Polysiphonia, which may be obtained alive with the Fucus, is the most available. Herbarium specimens of various species are most valuable for the vegetative structure, and the reproductive structures of a typical form may be shown from diagrams, the KNY series being especially good. The students may copy particular stages from such diagrams to fill gaps in their own studies; it is not a good practice if used often, but it is better than nothing when material is absent.

**Suggestions on Teaching.** — Up to the present this course has been concerned chiefly with training in fundamental botanical facts and phenomena, using the higher plants as a basis; information has been subordinate to the cultivation of eye and hand, and to the formation of scientific habits of mind and methods of work. From this time on, the object is to lead the student to make a close and sympathetic personal acquaintance, based on a good preliminary knowledge of general anatomy, morphology, and physiology, with the chief kinds of living plants and their habits. It is true that but few kinds of plants can be studied in the time usually available, but this difficulty can be minimized by the selection of forms as representative as possible of the great leading groups, and by the use of much accessory illustration. The aim should be to use a thorough study of certain forms as centers, and then, by aid of collections, pictures, and modeling, to secure the impression upon the minds of the student of a clear, sharply lined idea of the place in nature of principal members of each group, — what kinds of situa-



tions they inhabit, how they obtain their nourishment and reproduce, the meaning of the most constant characters of form, color, etc., and how each is related to the other groups.

There are so many excellent books, referred to in Chapter VIII, upon the natural history of the different groups, and, moreover, local conditions must determine so largely the exact materials to be used, that extended directions for the laboratory study are here inadvisable; and the outlines do little more than indicate the important points for study in any forms which may be selected under each group. Particularly clear and full outlines for the detailed study of all of these forms are given in CALDWELL'S *Handbook of Plant Morphology*, in BERGEN and DAVIS'S *Laboratory and Field Manual of Botany*, and in others of the laboratory manuals, mentioned at p. 206, earlier in this book.

It is of first importance that students see the forms they study as these appear when alive and growing in their native places. But when that is impossible, then the teacher should describe, as vividly as possible and with all available illustrations from museum specimens, photographs, etc., just where and under what conditions they grow; and such discussion of the forms in relation to their habits should be regarded as an indispensable preliminary to their study. For the same reason I think it is desirable to require a "character-drawing" of each plant studied, as an integral part of the description of its appearance and habitat. Even in *Pleurococcus*, where a single plant cannot be distinguished with the naked eye at all, the student gains far more accurate knowledge of the exact place of the organism in nature if he has to draw and describe the appearance of the colonies or masses of it, as they appear on a piece of bark from a tree,

than if, after a hasty glance at the living form, he confines his studies to magnified images. For these character-drawings, colored pictures are the best, and the fullest scope should be given the artistic talents of students; but a black and white drawing, leaving the colors to be explained in notes, is better than a coarsely or badly colored picture.

In the study of the various forms the teacher will, of course, keep prominent the adaptational, or ecological, phases of the subject. For *Pleurococcus*, obviously this is most simple, as the plant is unicellular and all functions are performed by one cell; substances are absorbed anywhere over the surface. *Vaucheria*, *Spirogyra*, and other floating forms are but little more complex; such forms have a very simple ecology. In the more complex forms, however, adaptations become more pronounced; special attention should be given to such matters as the thinness and fineness of division of the forms always immersed, in adaptation to the difficulty of obtaining a sufficiency of dissolved carbon dioxide, and especially of oxygen, from water: the toughness, elasticity, and powerful holdfasts of the kinds dwelling between tide marks, and therefore exposed to the full force of the waves: the bladders serving as floats: and the red and brown colors which are present, disguising the green, in adaptation to the peculiar light conditions. Consideration should also be given to the economic bearings of the forms, the subject not being ignored even when the uses are insignificant or wanting.

In this kind of study I think collecting is of great value. The collecting instinct is one of the chief attributes of the successful naturalist, especially of him who studies whole  
ms. The taking, the preparing, the keeping of speci-  
I have value in increasing acquaintance therewith,

and the reference to them from time to time afterward is a pleasure and a profit. But as most people lack this inclination, it is better to make the collecting voluntary. Algæ are easy to preserve. Of *Pleurococcus*, a little should be scraped carefully off, put on a small piece of paper, moistened, well spread out, and then placed between driers, with a bit of cotton cloth over the alga to keep it from sticking to the upper paper. *Spirogyra* should be floated out well in water, then paper should be slipped under it, and the whole lifted from the water, to be dried afterward as in the *Pleurococcus*. These may then be mounted in the book herbarium described elsewhere (see p. 163). A most valuable series may be made by mounting specimens of all the plants studied in this Part II, and thus would result a very instructive collection of types representing the groups from Algæ to Spermatophytes. This would accord with one division of the plan earlier recommended (p. 156).

Finally, the teacher should use all devices at his command to extend the limited laboratory knowledge of the few types to a more comprehensive conception of the Algæ in general. He should give some brief account of the other leading divisions of the group, including the Blue-greens, which are hardly practicable for study in this general course. If the teacher should desire a scientific term for this group, comparable with those ending in *-phytes* for the higher groups, the word "Phycophytes" would be entirely suitable.

## II. The Fungi

### A. *The Fission Fungi, or Schizomycetes*

72. Study representative forms of Bacteria.

- (1) Describe their appearance, habitat, and mode of nutrition.

- (2) What anatomical structure do they exhibit?  
What forms? Do they make colonies?  
Do they show movement?
- (3) What are the stages in their mode of reproduction by fission?  
What conditions and structures are involved in spore formation?
- (4) In what ways do Bacteria affect the interests of man?

B. *The Sugar-using Fungi, or Saccharomycetes*

73. Study the Yeast (*Saccharomyces cerevisiæ*).

- (1) Describe its appearance, habitat, and mode of nutrition.
- (2) What anatomical structure does it exhibit?
- (3) What are the structures and stages involved in its mode of reproduction:—
  - (a) by budding from the older cells?
  - (b) by spore formation?
- (4) In what ways does Yeast affect the interests of man?

C. *The Alga-like Fungi, or Phycomycetes*

74. Study the Bread Mold (*Rhizopus nigricans*).

- (1) Describe its appearance, habitat, and mode of nutrition.

- (2) What anatomical structure does it exhibit?  
Are the filaments (hyphæ) branched?  
Are they many-celled?
- (3) What structures and stages are concerned  
in its mode of reproduction:—
  - (a) Asexually, by spores from sporangia on  
long stalks from the hyphæ? How  
are these spores probably scattered?
  - (b) Sexually, by formation of zygospores  
from two uniting filaments? Is this  
process related to anything earlier  
studied?
- (4) In what ways do molds and their near  
relatives affect the interests of man?

**D. *The Sac Fungi, or Ascomycetes* (including the Lichens)**

**75. Study the common Lichen (*Parmelia*).**

- (1) Describe its appearance, habitat, and mode  
of nutrition.
- (2) What anatomical structure does it exhibit,  
both as to the mycelium of the Fungus,  
and the contained Alge?
- (3) What structures and stages are concerned  
in its mode of reproduction:—
  - (a) by its separate constituents, *i.e.* asco-  
spores from cups (*apothecia*) of the  
Fungus, and fission of the green Alge?

- (b) by its constituents collectively, through fragments of the thallus (*soredia*)?
- (4) What relation is believed to exist between the Fungi and Algæ making up the Lichen? Can the two live apart from the union?
76. What other prominent forms of Ascomycetes exist, and in what ways do they affect the interests of man?

E. *The Basidial Fungi, or Basidiomycetes*

77. Study the Mushroom (*Agaricus campestris*).
- (1) Describe its appearance (in its mycelium as well as its pileus stages), habitat, and mode of nutrition.
- (2) What is its anatomical structure? Is there any resemblance between the anatomical structure of the mycelium and that of the pileus?
- (3) What structures and stages are concerned in its mode of reproduction, asexually, by spores developed from basidia on the faces of the gills?
- (4) In what ways do Mushrooms and their relatives affect the interests of man?
78. What other prominent forms of Basidiomycetes exist, and in what ways do they affect the interests of man?

**Materials.** — The kinds of Fungi here recommended are easily obtained. Bacteria of several sorts, in good condition for study, may be procured abundantly from hay infusion, *i.e.* water in which hay has been placed and kept standing two or three days in a warm place, or from the water in which Lima Beans have been left standing two or three days, or from many other sources described in the several good books devoted to bacteriological methods and mentioned on an earlier page (p. 200). Yeast is easily prepared in perfect condition for study by placing a cake of compressed yeast in a solution of sugar (1 ordinary yeast cake to 150 cc. of water and 25 grams of sugar), which is then to be stood for an hour or less in a temperature approximating 28° C. It does not form spores in such a solution, but may be made to do so by cultivation, with somewhat special precautions, on plaster-of-paris plates. Bread mold develops usually, though not always, on bread kept for several days in a moist, warm, dark place; and the surest way to have it when wanted is to make cultures from dry material saved for the purpose. Mushrooms can be bought from the markets, or canned ones are almost equal y good. Lichens are available everywhere, especially upon old tree trunks.

**Suggestions on Teaching.** — In general the remarks under *Algæ* are applicable to this section also. It may seem that the range of material recommended is somewhat limited, and it is; but in fact, material for study of the Mildews, Rusts, and Smuts, etc., is difficult to provide for practicable detailed study by large classes, though it would be advantageous to introduce them. They can, however, be illustrated very well by museum specimens and pictures. The Bacteria and Yeasts are rendered somewhat difficult of study because of

their small size, but their great economic interest amply justifies their inclusion, and they should by no means be omitted.

Of course the teacher will lay much stress upon the economic matters so prominent in connection with this group, and will include under Bacteria not only some account of their part in causing diseases in man, but also their rôle in decay, cheese making, nitrification of soils, etc. And he will also, as under the Algæ, utilize all devices of illustration to give as comprehensive an exposition of the Fungi as possible.

As to the Lichens, they are sometimes treated, for practical reasons, as if they were a separate group, though this is not true of them scientifically. The former opinion, that they represented a symbiotic union involving mutual advantage between their fungal and algal constituents, appears no longer fully tenable; and the view seems to be growing in favor that they are simply Ascomycetous Fungi which have enslaved, as it were, certain Algæ.

The relationships of these different Fungi to one another and to other groups are important. It is generally believed that Fungi are descended, with degeneration due to parasitism, from Algæ, not, however, from one group of the latter but from several, while some of the Fungi have become much specialized into subgroups since their departure from the Algæ. But there is great difference of opinion as to the details of the relationships between the different subgroups. The facts, — in a very general way, however, and so far as they should be known to students in a general course, — are intended to be brought out in the diagrammatic tree of relationships given a few pages later in this book.

If the teacher should desire a scientific term for this group,



comparable with those ending in *-phytes* for the higher groups, the word "Mycophytes" would be entirely suitable.

### III. The Moss Plants, or Bryophytes

#### A. *The Liverworts, or Hepaticæ*

79. Study the *Marchantia* (*M. polymorpha*).

- (1) Describe its appearance, habitat, and mode of nutrition.
- (2) What is the anatomical structure of the thallus, inclusive especially of the peculiar stomata and their relation to the air chambers?
- (3) What structures and stages are involved in its reproduction:—
  - (a) Vegetatively by gemmæ, formed in cups on the thallus?
  - (b) Sexually through the fertilization of egg cells, borne in archegonia on the smaller receptacles, by spermatozoids formed in antheridia on the larger receptacles? What structure results from the growth of the fertilized egg?
  - (c) Asexually by spores formed in a sporogonium?

Consider comparatively the general structure and mode of reproduction of other forms of Liverworts, in-

cluding Riccia at one extreme and Anthracium at the other, especially with reference to the alternation of generation viz. the asexual sporophyte and the sexual gametophyte).

### B. *The True Mosses, or Musci*

#### 8c. Study the Funaria.

- (1) Describe its appearance, habitat, and mode of nutrition.
- (2) What is the general structure and anatomy of the plant, including its relation to its protonema?
- (3) What structures and processes are concerned in its reproduction:—
  - (a) Sexually, by the fertilization of egg cells, in the archegonia at the tips of some stems, by spermatozoids formed in antheridia at the tips of others?
  - (b) Asexually, by spores formed in a capsule?
- (4) Do you recognize the two generations in the Moss, and the correspondence thereof with those of the Liverworts?

**Materials.** — *Marchantia*, although not very typical, is certainly the most available Liverwort for study in a general course, especially as concerns the ease of acquisition and study of the archegonia and antheridia. It may be collected

in summer, when the receptacles are ripe, and preserved in formaline, but it may also be kept alive over winter, in greenhouses, where indeed it occurs naturally in neglected places. If such material, which rarely is found in fruit, be placed, in autumn, in shallow boxes of soil, which are then brought into a very brightly lighted and moderately warm place, the plants can be forced to produce the receptacles in the spring. At a pinch the fruiting material can be bought from botanical supply companies. The leafy *Jungermannia* forms can readily be found in damp woods by persons who know them.

As to mosses, *Funaria*, which is common everywhere, is one of the best, especially since it allows the capsules to be sectioned easily. It is difficult to find and study the archegonia of mosses, of which prepared sections should be provided.

**Suggestions on Teaching.** — Of course, as before, the teacher will broaden the students' conceptions of these groups by suitable exposition and illustration, and he will find it worth while to call their attention to such facts as the probable derivation of the Liverworts from Algæ through the floating forms: the transition they mark from the water to the land habit: the position of the mosses as a side and barren branch: and the existence of distinct alternation of generations in the Bryophytes, even though the full significance thereof will not become apparent until after they have studied the Pteridophytes.

#### IV. The Fern Plants, or Pteridophytes

##### A. *The true Ferns, or Filicineæ*

##### 81. Study a representative Fern.

The inconspicuous sexual generation (prothallium),  
or Gametophyte.

- (1) Describe its appearance, habitat, and mode of nutrition.
- (2) What anatomical structure does it exhibit? Do you find the growing point? The rhizoids?
- (3) What are the structures and stages concerned in its mode of reproduction through the fertilization of egg cells, contained in archegonia, by spermatozoids developed in antheridia?

Through what stages does the fertilized egg cell pass in development to a sporophyte?

The prominent asexual generation, or Sporophyte.

- (1) Describe its general appearance, habitat, and mode of nutrition.
- (2) What general structure and anatomy does it exhibit?
- (3) What are the structures and stages concerned in its mode of reproduction by the asexual spores formed in the sporangia?

What constant relationship exists between Gametophyte and Sporophyte?

#### B. *The Club Mosses, or Lycopodineæ*

82. Study, from living material if possible, but otherwise from good descriptions, the of the typical Club Moss

83. Study the *Selaginella* (*S. Kraussiana*).

- (1) Describe the appearance, habitat, and mode of nutrition of the sporophyte.
- (2) What general structure and anatomy does it exhibit?
- (3) What structures and stages are concerned in its mode of reproduction from megaspores and microspores, which develop inclosed prothallia (gametophytes), bearing archegonia with egg cells and antheridia with spermatozoids?
- (4) Do you understand the difference between homosporous forms (like *Filices*) and heterosporous forms (here considered), and between a relatively large free-living prothallium and a small inclosed and "parasitic" prothallium?

### C. *The Horsetails, or Equisetineæ*

84. Study, preferably from actual material, but if that be unavailable, from good descriptions, the natural history of representatives of this group.

**Materials.** — As to the true ferns, the sporophyte is always available in all greenhouses. The prothallia are so small and inconspicuous that it is almost impossible to discover them out of doors, but they can be found on neglected flower pots, old brick walls, or earth in greenhouses, although

if such houses are kept as clean and orderly as they should be, no material will be available from this source. The best way is to raise the prothallia on purpose, when they will be available in great abundance and in all stages exactly when needed. They may be raised thus: Shallow pots (seed pans) some four inches in diameter are filled with soil upon which ripe spores are shaken from a mature fern frond. The pan is then stood in a saucer kept well supplied with water, and is covered with a sheet of glass, occasionally lifted and shaken free of adherent water drops. The saucers are stood in a warm place (about 20° C.), moderately lighted (from the north) when the prothallia will develop well, and come into condition for study in about two months (sooner in summer), while later they will show also the stages of development of the young sporophytes. Certain heterosporous Filicineæ, notably *Salvinia* and *Azolla*, can be kept alive in shallow pans in a greenhouse, though they are very eccentric in their fruiting. As to Lycopodineæ, the homosporous forms can be secured only out of doors, but can well be illustrated from herbarium materials. Various species of *Selaginella* (of which *S. Kraussiana* is most common) grow readily in greenhouses, and are always kept in stock by florists; they present the microspores and megaspores in good condition in winter and early spring. The germination and the study of the tiny prothallium of these is too difficult for this course, and must be illustrated from good pictures. The Equisetaceæ can be studied in a general course only from materials collected in advance out of doors, since no greenhouse material is available.

**Suggestions on Teaching.** — This group of Pteridophytes, while vastly interesting and important, presents so much

complication of structure and so many practical difficulties in the study of the most essential points, that careful selection of topics and a considerable amount of didactic treatment of the subject is necessary. The teacher here comes actively into contact with alternation of generations at its best, and with the various morphological changes in the transition from one group to another, especially in the formation of the seed habit. The study of these morphological transitions never fails to fascinate the teacher who goes personally into them, but he should remember that their full understanding requires a considerable background of knowledge and some maturity of thought and interest, and that, while students can be made to understand them, it is knowledge of a kind which appeals to them little, and is soon forgotten. Hence, I think no great stress should be laid upon such matters in a general course. It is far more important to give emphasis to the general life conditions, habits, and identities of the striking and attractive plants in this group; nor should the teacher fail to call attention to the beauty of the ferns, and the part they play in appealing to the æsthetic faculties of man. The *Selaginella* is, of course, introduced to give knowledge of the two kinds of spores, which mark the transition to the seed and pollen of the flowering plant; and this subject should be treated in general, even though not in detail.

## V. The Seed Plants, or Spermatophytes

### A. *The Gymnosperms*

85. Study the Pitch Pine (*Pinus rigida*).

- (1) What is its appearance, habitat, and mode of nutrition?

- (2) What is the structure of the sporophyte, especially as to the position and arrangement of leaves, and cones of two kinds?
- (3) What is the structure, and apparent morphology of the staminate cone, including the scales, anthers, and pollen grains?
- (4) What is the structure and apparent morphology of the ovulate cone, including the scales and ovules, with their integuments and micropyle?
- (5) What structures and stages are concerned in sexual reproduction through fusion of an egg cell developed by the prothallium within the megaspore, and a sperm nucleus developed by the prothallium formed by the microspore?

#### B. *The Angiosperms*

86. Review, from the present point of view, and following the general outline of exercise 85 above, the structure and morphology of the Angiosperms, with attention to the structures and stages concerned in fertilization and reproduction, and a consideration of the differences between monocotyledons and dicotyledons.
87. Prepare a diagrammatic representation of the relationships of the groups from Algæ to Angiosperms,



showing how one group is supposed to have been evolved from another.

**Materials.** — The male and female flowers of most pines are in condition for study in May, when this work is reached, though material is also good if collected and preserved in formaline. Pitch pine affords particularly good material, especially as offered by sapling trees. With the younger stages should be collected some of the year-old cones. As to the study of the Angiosperms, the limitations of time may confine that to a review of the earlier studies, but in any case an abundance of good material will be available out of doors at the time when this work will come.

**Suggestions on Teaching.** — While the general structure of Spermatophytes is easy enough for study, the structures within ovule and pollen grain are mostly too difficult for the student of this course to work out for himself, and much use will have to be made of preparations and good pictures. As I have stated on a previous page, I do not think it is desirable to attempt to teach students in a general course the full significance of morphological transitions from group to group, although this should be explained to them in a general way as a matter of much scientific interest which they can go thoroughly into if they pass on to advanced courses. It is well, however, to use the correct morphological terms for the parts, giving megaspore, microspore, etc., along with the older terms. As to the morphology of the scales of the cones in Gymnosperms, the teacher will not, of course, attempt to homologize them with parts of carpels; no such homology is possible, for, as we now know, Gymnosperms and Angiosperms have had independent origins from different groups of Pterid-

ophytes, and cone scales and carpels have had no connection with one another. Of course the teacher will give, along with the Pines, etc., an account of the Cycads, with especial attention to their striking mode of fertilization by free-swimming spermatozoids released from a wind-carried pollen grain,—a condition beautifully intermediate between the arrangements prevailing in the lower and higher plants. He can also make clear, at this point, the importance of the pollen grain (easily transportable by external moving agencies, and with its growing tube independent of water fertilization) in enabling plants to free themselves from dependence upon water in fertilization, and hence to grow to a great size upon land. It is possible in this way to give students some vivid idea of the great facts on which our belief in evolution is based, though the attempt to teach anything about the subject in detail is out of place in a general course, especially in a high school.

As to the construction of diagrams to exhibit relationships of the groups to one another, the students cannot do much by themselves, but with aid of the teacher they can work out a scheme something like that which is shown in the figure herewith (Fig. 40). The mode of branching indicates the supposed mode of origin of the groups from one another; thus the Algæ were once the dominant and principal group in the main line of evolutionary advance; from these the Bryophytes came off as a side branch, soon, however, as a result of better adaptation to new physical conditions, themselves assuming the main line of advance and thus forcing the Algæ aside to a minor evolutionary position. Later the Pteridophytes, arising as a branch from Bryophytes, became the principal group, displacing the latter, while in turn they

gave origin to the Angiosperms. In a general way we know the features which enabled each group to climb to a higher

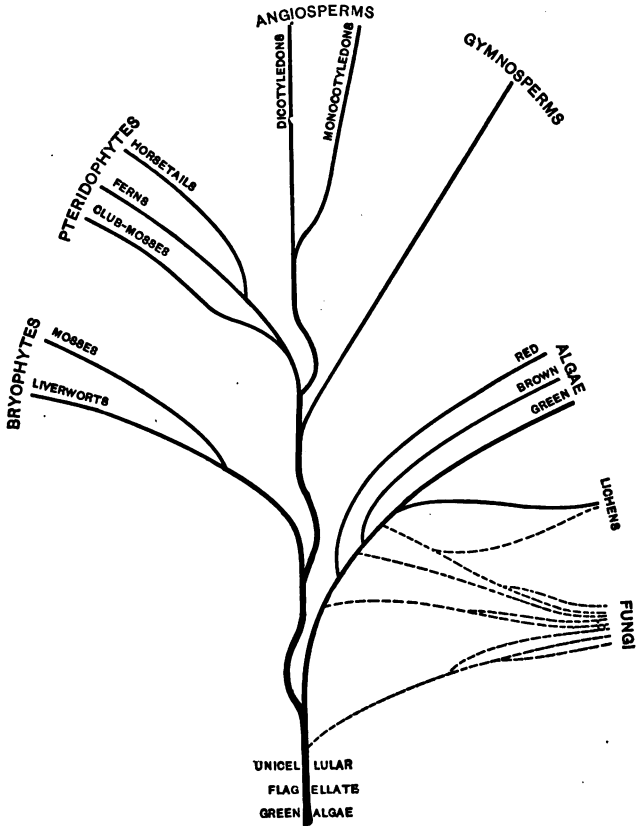
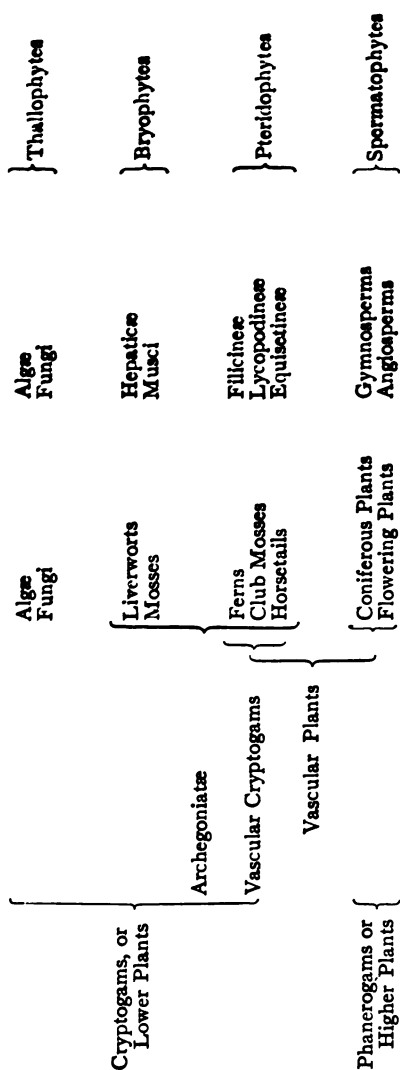

FIG. 40.—Hypothetical tree of relationship and descent of the leading Groups of Plants.

plane than its predecessors, the general line leading along increasing adaptation to the land habit. Certain groups, on



the other hand, appear never to have occupied the main line, but are side branches from the other groups; the same seems true of Fungi, which are side branches from several origins in Algæ; of Mosses, a side branch from the Liverworts; of Gymnosperms and Monocotyledons as shown by the diagram. There is still very much doubt as to the details of the relationships, but I think the diagram is in conformity, so far as it goes, with existent knowledge.

The students, in consulting different books, may be somewhat confused by the various names applied to the same groups. Hence the teacher may find it advantageous to give them some such scheme as is outlined herewith.

These outlines, ob-

viously, only lead up to an understanding of the general features of the higher plants, but do not attempt to guide the student to the very desirable further study of them. Custom and opportunity impose very different usage in this matter in different places. In case the plan is followed of giving a whole year to the study of the groups, there is then ample time for much more study of these higher plants, and it becomes desirable to follow them into their subgroups, families, etc., down to the species. This involves the use of manuals for identification, and field work, with collecting, on which I have already offered such suggestions as I can upon earlier pages (pp. 45-48). Certainly such knowledge of plants is indispensable to every person seriously concerned with Botany, but its study does not seem to me appropriate for general classes working under usual conditions. We need to set our investigating ingenuity at work upon this, as upon so many others of our still unsolved educational problems. But in these very problems there lies open to every teacher a field for investigation which is not only extremely attractive but much needed as well. He who gives us a new device for the more logical proof of a fundamental principle, better materials, appliances, or experiments for the more illuminating illustration of a difficult topic, or more effective methods for treating a recondite subject, renders to education a service like his to humanity who makes two blades of grass grow where one grew before.



## APPENDIX

### THE PRINCIPAL STANDARD OR UNIT COURSES IN GENERAL BOTANY FORMULATED BY REPRESENTATIVE COMMITTEES IN AMERICA

OF these there have been four, of which the two earlier, formulated by Committees of the National Educational Association, viz. those in the "Report of the Committee of Ten" (Washington, 1893), and the Report on College Entrance Requirements (Chicago, 1899) have been superseded by the two which follow.

#### *I. The Course of the Botanical Society of America and the College Entrance Examination Board.*

This course is that used by the College Entrance Examination Board as a basis for its examinations held annually in June in all the States of the Union and several foreign countries. The examinations admit students to most of the colleges and universities of this country, as particularized in a note on a later page (421). It was formulated in 1901, after extensive consultation with botanical teachers throughout the country, by a committee of botanical teachers, now the Committee on Education of the Botanical Society of America (consisting of W. F. Ganong, of Smith College, F. E. Lloyd, of the Alabama Polytechnic Institute, and H. C. Cowles, of the University of Chicago), which committee is directed by the Society to recommend such changes as shall keep the

course in touch with changing educational conditions and advancing educational opinion. It has been rewritten, with minor changes and improvements, four times, and is here rewritten with some omission of preface and historical material from the fourth edition, published in *The School Journal* for November, 1923, the specifications being identical with those published by the College Entrance Examination Board in its official documents.

#### PRINCIPLES UPON WHICH THE COURSE IS FOUNDED

1. It is founded upon the two important Reports of the National Educational Association — the *Report of the Committee of Ten* (Washington, 1918), and the *Report of the College Entrance Requirements* (Chicago, 1919). These have been modified in accord with the results of more recent surveys and the action of leading teachers.

2. While intended primarily as an outline for teachers to follow, it is designed equally for the education of the high school in the general student who can follow the subject in detail. There are a variety of advantages in having the course prepared and the general educational courses adjusted so that none has to be in any way connected with the material which has to be done in school.

3. It is assumed that a student desiring only a general education should not be required to take courses in any other subject which are not part of the course.

4. It is assumed that a student who is interested in a course should not be required to take other courses which are not part of the course. It is assumed that a student who is interested in a course should not be required to take other courses which are not part of the course. It is assumed that a student who is interested in a course should not be required to take other courses which are not part of the course.

5. It is assumed that a student who is interested in a course should not be required to take other courses which are not part of the course. It is assumed that a student who is interested in a course should not be required to take other courses which are not part of the course.



whether for their value in scientific training, or as knowledge; but the individual teacher is left free to follow his own judgment as to sequence of topics, text and other books, and special methods. Advice is occasionally offered, however, upon important points in which most teachers are now known to agree.

6. It recognizes the existence of, and provides for, two modes of procedure in the sequence of topics. In one, which is that strongly advised by the committee, the general facts of plant structure and function, permitting a beginning with large and familiar objects and phenomena, are first studied, to be followed later by a study of representatives of the groups of plants from the lower to the higher; in the other the study of the groups is the backbone, as it were, of the course, which begins with the lowest forms and introduces the physiological and morphological topics at appropriate places in the ascending series. The two modes, however, lead to substantially the same result, and a common examination is practicable for both.

7. The amount of work in the course is designed to occupy a year of five periods a week under good conditions. Where special circumstances, such as exceptional difficulty of obtaining material, etc., prevent the completion of the entire amount while allowing its equivalent in thoroughness, it is recommended that some of the minor topics here and there be omitted rather than that the attempt be made to cover all superficially. To provide for this possibility the examination papers should always include a number of alternative questions.

8. The time per week, inclusive of recitation, preparation, and laboratory should be the same as for any other subject. Where five periods a week, with an hour of preparation for each, are demanded for other studies, this course should receive the equivalent of two recitation periods with their preparation, together with three double (not six separated) periods in the laboratory. Variation from this should be towards a greater, not a lesser proportion of laboratory work. The preparation of records of the laboratory work, in which stress is laid upon diagrammatically accurate drawing and precise and expressive description, should be regarded as an

integral part of the course; and these records, preferably in a notebook, should be counted at least one third towards the students' standing.

9. The course is arranged in two parts, each occupying a half year and complete in itself. This is in part to accord with principle 6, preceding, and in part to allow either a combination of a half year of botany with a half year of zoölogy to form a year's course in biology, or else to provide a shorter course as needed in some schools. In any case a half-year course in botany should consist of Part I or Part II, never of a combination of both, a recommendation based partially upon educational principle and partly upon the practical difficulty of providing examinations and articulating later college courses with such diverse combinations.

10. The course is intended to be relatively permanent, yet is modifiable in adaptation to changing educational conditions and the approved results of experience. Changes will not, however, be made for some time, and not until announced in a fifth edition of this report. The committee will welcome all suggestions and criticisms.

### SPECIFICATIONS OF THE TOPICS TO BE STUDIED

#### PART I. THE GENERAL PRINCIPLES OF (A) ANATOMY AND MORPHOLOGY, (B) PHYSIOLOGY AND ECOLOGY

##### A. ANATOMY AND MORPHOLOGY.

The Seed. Four types (dicotyledon without and with endosperm, a monocotyledon, and a gymnosperm); structure and homologous parts. Food supply; experimental determination of its nature and value. Phenomena of germination and growth of embryo into a seedling (including bursting from the seed, assumption of position, and unfolding of parts).

The Shoot. Gross anatomy of a typical shoot; including the relationships of position of leaf, stem (and root), the arrangement of leaves and buds on the stem, and the

deviations (through light adjustment, etc.) from symmetry. Buds, and the mode of origin of new leaf and stem; winter buds in particular. Specialized and metamorphosed shoots (stems and leaves). General structure and distribution of the leading tissues of the shoot; annual growth; shedding of bark and leaves.

**The Root.** Gross anatomy of a typical root; position and origin of secondary roots; hair zone, cap, and growing point. Specialized and metamorphosed roots. General structure and distribution of the leading tissues of the root.

**The Flower.** Structure of a typical flower, especially of ovule and pollen; functions of the parts. Comparative morphological study of four or more different marked types, with the construction of transverse and longitudinal diagrams.

**The Fruit.** Structure of a typical fruit. Comparative morphological study of four or more marked types with diagrams.

This comparative morphological study of flowers and fruits may advantageously be postponed to the end of II, and then taken up in connection with classification of the Angiosperms.

**The Cell.** Cytoplasm, nucleus, sap cavity, wall.

As to the study of the cell, it is by no means to be postponed for consideration by itself after the other topics, as its position in the above outline may seem to imply, but it is to be brought in earlier, along with the study of the shoot or root, and continued from topic to topic. Although enough study of the individual cell is to be made to give an idea of its structure (a study which may very advantageously be associated with the physiological topics

mentioned first under B), the principal microscopical work should consist in the recognition and study of the distribution of the leading tissues.

#### B. PHYSIOLOGY AND ECOLOGY.

Rôle of water in the plant; *absorption (osmosis), path of transfer, transpiration, turgidity and its mechanical value, plasmolysis.*

Photosynthesis; *Dependence of starch formation upon chlorophyl, light, and carbon dioxide; evolution of oxygen, observation of starch grains.*

Respiration; *need of oxygen in growth, evolution of carbon dioxide.*

Digestion; *Digestion of starch with diastase, and its rôle in translocation of foods.*

Irritability; *Geotropism, heliotropism, and hydrotropism.*

Growth; *localization in higher plants; amount in elongating stems; relationships to temperature.*

Fertilization; sexual and vegetative reproduction.

Although for convenience of reference the physiological topics are here grouped together, they should by no means be studied by themselves and apart from anatomy and morphology. On the contrary, they should be taken up along with the study of the structures in which the processes occur, and which they help to explain; thus, — photosynthesis should be studied with the leaf, as should also transpiration, while digestion may best come with germination, osmotic absorption with the root, and so on. The student should either try, or at least aid in trying, experiments to demonstrate the fundamental processes indicated above in italics.

Modifications (metamorphoses) of parts for special functions.

Dissemination. Cross pollination.

Light relations of green tissues; leaf mosaics.

• Special habitats; Mesophytes, Hydrophytes, Halophytes, Xerophytes; Climbers, Epiphytes, Parasites (and Saprophytes), Insectivora.

The topics in ecology (particularly the first four and in part the fifth), like those in physiology, are to be studied not by themselves, but along with the structures with which they are most closely associated, as cross pollination with the flower, dissemination with the seed, etc. The fifth may most advantageously be studied with G in Part II.

In this connection field work is of great importance, and, for some topics, is indispensable, though much may be done also with potted plants in greenhouses, photographs, and museum specimens. It is strongly recommended that some systematic field work be considered as an integral part of the course, coördinate in definiteness and value as far as it goes with the laboratory work. The temptations to haziness and guessing in ecology must be combated.

## PART II. THE NATURAL HISTORY OF THE PLANT GROUPS, AND CLASSIFICATION

A comprehensive summary of the great natural groups of plants, based upon the thorough study of the structure, reproduction, and adaptations to habitat of one or two types from each group, supplemented and extended by more rapid study of other forms in those groups. Where living material is wanting for the latter, preserved material and even good pictures may be used, and a standard text-book should be thoroughly read. The general homologies from group to group should be understood, though it is not expected that these will be known in detail.

In general, in this part of the course, it is recommended that much less attention be given to the lower and incon-

splendour groups, and progressively more to the higher and conspicuous forms.

Following is a list of recommended types from which, or their equivalents, selection may be made: —

A. ALGÆ. Pleurococcus, Sphærella, Spirogyra, Vaucheria, Fucus, Nematium (or Polysiphonia or Coleochæte).

B. FUNGI. Bacteria, Rhizopus or Mucor, Yeast, Puccinia (or a powdery mildew), Corn Smut, Mushroom.

Bacteria and Yeast have obvious disadvantages in such a course, but their great economic prominence may justify their introduction.

C. LICHENS. Physcia (or Parmelia, or Usnea).

D. BRYOPHYTES. In Hepaticæ, Radula (or Porella or Marchantia). In Musci, Mnium (or Polytrichum or Funaria).

E. PTERIDIOPHYTES. In Filicineæ, Aspidium or equivalent, including, of course, the prothallus.  
In Equisetineæ, Equisetum.  
In Lycopodiineæ, Lycopodium, and Selaginella (or Isoetes).

F. GYMNOSPERMS. Pinus or equivalent.

G. ANGIOSPERMS. A monocotyledon and a dicotyledon, to be studied with reference to the homologies of their parts with those in the above groups; together with representative plants of the leading subdivisions and principal families of Angiosperms.

Classification should include a study of the primary subdivisions of the above groups, based on the comparison of the ~~with other living~~ <sup>with other living</sup> ~~preferably~~ <sup>preferably</sup> or preserved material.

The principal subdivisions of the Angiosperms, grouped on the Engler and Prantl system, should be understood.

The ability to use manuals for the determination of the species of flowering plants is not considered essential in this course, though it is most desirable. It should not be introduced to the exclusion of any part of the course, but should be made voluntary work for those showing a taste for it. It should not be limited to learning names of plants, but should be made a study in the plan of classification as well.

The preparation of an herbarium is not required nor recommended except as voluntary work for those with a taste for collecting. If made, it should not represent so much a simple accumulation of species as some distinct idea of plant associations, or of morphology, or of representation of the groups, etc.

[The examinations in Botany of the College Entrance Examination Board, held upon the foregoing course, are now accepted by the principal universities and colleges of the country, especially in the eastern states. Those which make statement to this effect in their official publications, so far as I happen to know them, are, — *Bryn Mawr, California, Cincinnati, Columbia, Cornell, Dartmouth, Harvard* (although it can count for only a half year), *Illinois, Leland Stanford, Maine, Massachusetts Institute of Technology, Massachusetts Agricultural College, Mount Holyoke, Nebraska, Northwestern, Ohio, Pennsylvania, Rochester, Simmons, Smith, Syracuse, Washington (St. Louis), Wellesley, Wells, Vermont, Woman's College of Baltimore, Yale Scientific School*. And there are doubtless others which I have not noticed. Furthermore, I am told that certain others, although making no official statement thereof, will also accept the Board's examinations, and these include *Chicago, Haverford, Kansas, Minnesota, Missouri, North Carolina, Oberlin, Wabash, Williams*. The number and importance of the institutions accepting the Board's examinations, in conjunction with the widening appreciation of the Board's work, indicate that the acceptance of these examinations in Botany is now nearly, and soon will be entirely universal.

The present importance of this fact consists in this, that high schools can now give this course in the assurance that it can be counted at full value for admission to the principal higher institutions. *Note by the author of this book.*]

*II. The Unit Course in Botany Formulated by a Committee of the Association of Colleges and Secondary Schools of the North Central States.*

This unit course has been formulated by a representative committee of twenty-two teachers of colleges and secondary schools, of which Professor O. W. CALDWELL, of the University of Chicago is chairman.<sup>1</sup> The personnel of the Committee, together with some account of its work, is published in *School Science and Mathematics* for October, 1909. The unit was formally adopted by the Association on March 25, 1910.

*Definition (1 unit)*

It has been the intent of the committee to prepare a statement that is sufficiently elastic to give adequate recognition to all good courses in high school botany, rather than to present a set line of procedure that must be followed by all. The work that is done should meet the needs of the pupils, regardless of whether any work is to be done in any higher institution. Emphasis is placed upon the quality and quantity of the work done, and upon the preparation of the teacher, rather than upon the particular things that are to be done. To this end the report considers the following:—

I. The purpose and content of the course and the time to be given to it.

<sup>1</sup> For the opportunity to publish the unit in this book I am very much indebted to the kind interest and aid of Professor CALDWELL.



II. Suggested plan of the course.

III. The preparation that should be had by the teacher of botany.

The committee wishes to express its appreciation of the work done by the committee on education of the Botanical Society of America. This committee, previously working as the committee of the Society for Plant Morphology and Physiology, of the College Entrance Examination Board, and later of the Botanical Society of America, has published four reports, the latest in the *School Review* for November, 1908. These reports have been most potent in giving purpose and organization to the teaching of botany in secondary schools. The unit statement here presented is in agreement in many respects with the last report of the above-mentioned committee, but differs from it in flexibility, recognition of the practical aspects of plant life, in definition of the preparation of the teacher, and in some other points. It is hoped that sometime there may be a single statement of the unit issued by the two committees.

*I. The purpose and content of the course, and the time that should be given to it.*

1. The ends to be sought through an elementary study of plant life include training in the scientific method of thinking, particularly as relates to plant life, information and a more intelligent and a more active interest in natural phenomena in general, an elementary knowledge of fundamentals of plant life and a better understanding of those features and activities of plants that relate to everyday affairs.

2. In determining the content, order, and treatment of topics in any individual course, the needs and opportunities of the teacher and class should be dominant. To this end this statement includes the general features of the course, the teacher being left at liberty to adopt such details as best meet the needs

of any particular class of pupils. The quality and quantity of work done by the pupil, evidence of his ability to do accurate and reliable work, and adequate preparation by the teacher, rather than the specific content of the course, are emphasized.

3. There is presented a general plan of the "synthetic course," which the majority of the committee believes to be the best type, though it is not intended to restrict teachers to this type of course. This course embodies the elements of morphology of the great groups including the "lower forms" as well as the seed plants, of physiology with experiments upon plant activities, of ecology with emphasis upon class and individual field trips, including some acquaintance with local plants, of the relation of plants to their habitat and to men, of food and timber supply, parasitism, disease, decay, soil replenishment, etc. It is recommended, however, that plants be studied in an elementary way, leading into any or all of the above aspects, rather than that the differentiated divisions of the subject be taken up at one time.

An elementary consideration of the relations of plants to men, as shown in plant and animal diseases, hygiene, agriculture, horticulture, erosion, decay, foods, fibers, etc., should be presented as an organic part of the study of botany. The inclusion of these practical matters as an organic part of the course rather than as a number of sections upon the applied aspects of plants, gives appreciable meaning and fuller significance to the study. An adequate consideration of such separate applied sciences as agriculture, forestry, bacteriology, and horticulture should follow the general study of plants and animals.

4. The time requirement of the course should be the equivalent of 180 periods of at least 40 minutes each; there should be

two doubled periods per week for laboratory or field work, each of these doubled periods counting as one period in making up the total 180 periods.

*II. Suggested plan of the Course.* This is a plan for a synthetic course. It suggests more material than any one year's work can present. Some of the topics will receive more emphasis at the hands of teachers who prefer to treat briefly or omit other topics, the ones selected for full or brief treatment varying with different teachers. In order of treatment consideration may first be made of the structure and function of seed plants, or of the characteristics of the great groups of plants.

1. In beginning the course with a study of seed plants, the first work may deal with *any* of the following topics, the one selected for the beginning serving to lead directly to others of the group:—

The structures of a typical seed plant — roots, stem, leaves, flowers, and seeds — and the kinds of work done by these parts.

How the plant lives — elementary physiological experiments, absorption, root pressure, conduction, transpiration, photosynthesis, relation of functions to the structures by means of which they are performed.

The work of leaves.

The storage of food, its relation to the plant; its relation to men and other animals.

Seeds and seedlings; seed distribution; the establishment of new plants.

Acquaintance with some of the plants of the locality.

2. In addition to the topics just named, due to seasonal advantage, preferences of the teacher, or needs of the pupils,

the following will at times be found best in this connection, while in other cases it will be found best to take up these topics after the consideration of the great groups:—

Relation of plants to light, soil, water, atmosphere, gravity, contact, seasons.

Growth and reproduction.

Responses to different regions.

Artificial control and methods of improving agricultural and horticultural plants.

Forests, their uses, distribution, dangers, and preservation.

3. The Great Groups. In the following outline, what plants are and what they are doing in the locality are to be kept prominent, although these matters cannot be studied apart from plant structures.

It is recommended that detailed anatomical work be reduced to the minimum, and that gross structures and life habits be given correspondingly larger attention. By means of demonstrations many of the details may be made of more value than would be true if pupils were to try to study out these details by means of the compound microscope. When compound microscopes are available, some of the structures may be determined by the pupils, but often it is better to use demonstration microscopes. A full study of gross structures will give a good basis for understanding demonstrations through microscopes, and pictures of the important details.

a. ALGÆ. General appearance and distribution; local types studied with reference to their places of living, their nutritive and reproductive structures and habits, conditions controlling their growth and reproduction. Two or three blue-green forms as *Nostoc* and *Oscillatoria*, and such green forms as *Pleurococcus*, *Cladophora*, *Spirogyra*, *Vaucheria*,

and the desmids. The gradations in complexity in nutritive and reproductive structures should be understood, but no attempt at establishing a detailed evolutionary series should be made. The characteristics of these forms should be studied out-of-doors and in the aquarium. Their distribution and abundance in the locality, and their relation to water supplies, should receive attention.

General appearance and regional distribution of the red and brown algæ, but no detailed work with them, is recommended. Gross characteristics of diatoms in fresh water should be noted.

*b. FUNGI.* Some of the following common forms as types of dependent plants — toadstools and mushrooms, mildews, water mold, wheat rust, corn smut, cedar apples, etc.

Parasitic method of living and its helpful and harmful economic significance; regulation and elimination of injurious fungi.

Yeasts and fermentation.

Bacteria studied chiefly with reference to life habits and effects. Relation of the bacteria to decay, to soils, to leguminous plants, to rotation of crops, and to sanitation. Bacteria as instruments of disease. Sterilization as shown in a study of milk. Purity of milk and water supply. Relation of knowledge of bacteria to public hygiene.

*c. LICHENS.* A type used to illustrate the interrelation of algæ and fungi. Distribution of the lichens of the locality and their influence upon their supporting structures.

*d. LIVERWORTS.* Life habits, distribution, and life cycle.

*e. MOSSES.* Life habits, distribution, and life cycle.

*f. FERNS.* Life cycle of a true fern, stem and leaf in relation to chlorophyl work; perennial nature; distribution; acquaintance with a few local types.

General characteristics of the horsetails and club mosses.

*g.* GYMNOSPERMS. Pine or spruce as a type; habit of tree, perennial nature, twigs and stems of different ages, age of tree, leaves and the evergreen habit, nature of the timber and its uses; two kinds of cones and the processes, time, and structures involved in seed formation, nature of the seed, seed distribution, seedlings, and the establishment of the new tree.

Names of other kinds of gymnosperms.

Gymnosperms as source of much of the world's lumber supply, chief regions of gymnosperm forests, preservation and extension of gymnosperm forests.

*h.* ANGIOSPERMS.

Life cycle as compared with the gymnosperms.

Types of stem, root, leaf, and flower structure, with consideration of the special work, habits, and uses of each of these.

Nutritive and reproductive processes arranged so as to extend whatever work was done with seed plants at the beginning of the course. Work suggested at the outset that was not done in that connection may be included here.

Pollination and seed formation, number of seeds, seed distribution, seedlings, vitality of seeds, struggle for existence.

Structures and habits of plants of different regions.

Acquaintance with plants of the leading families in the local region.

Angiospermous forests (possibly delay the consideration of gymnospermous forests until this point), the local timber supply either from local forests or from others, enemies of the forests, elementary forestry problems, United States, State, and local private work in forestry.

Relation of plants to soil, water, light, temperature, gravity, and other environmental factors. Productive and unproductive soils and climates in relation to agricultural plants.

Diseases of plants and their significance. Artificial improvement of plants through cultivation, pruning, grafting, selection, and breeding.

*III. The Qualifications of the Teacher of Botany.*

It is believed that the teacher of botany in the high school should have a minimum preparation in botany equivalent to two years of college work. This work should include the general morphology of the lower and higher groups, elementary plant physiology and ecology; zoölogy, physiography, and a course in general bacteriology are desirable. The teacher should also have some knowledge of the purpose of botany in high school education and of current and desirable practice in teaching botany.

Since the teacher of botany usually teaches other sciences each demanding somewhat similar quantity of preparation, obviously to maintain this standard more general and more extensive preparation needs to be urged. This standard of preparation is deemed highly desirable in order to give botany its proper place in secondary education, but it may not always be practicable. It is the standard that should be met by those who are now preparing to teach the subject.

1

2



## INDEX

- Absorption of water, 40, 342, 344, 418.  
 Aération system, 328, 330, 336.  
 Aërial roots, 305.  
 AGASSIZ, L., 176.  
 Agriculture, 44.  
 Albuminous, 267, 269.  
 Alcohol, for specimens, 153.  
 Algæ, 41; natural history, 386; materials, 388, 420, 426.  
 Alternation of generations, 400, 401, 405.  
 Aluminum shells, 332.  
 American Association for the Advancement of Science, 56.  
*American Botanist*, 183, 214.  
 Analysis of flowers, 46.  
 Anatomy, 37, 310.  
 ANDREWS, E. F., 208, 214.  
 Angiosperms, study, 406, 420, 428.  
 Annual rings, 338.  
 Anthers, 352.  
 Anthoceros, 400.  
 APGAR, 209.  
 Apparatus for physiology, 134; types, 134; firms supplying, 134.  
 Aquaria, 125.  
 ARTHUR and MACDOUGAL, 180, 214.  
 ARTHUR, BARNES, and COULTER, 205, 206, 214.  
 Ascomycetes, 395.  
 Ascophyllum, 388.  
 Assimilation, 40.  
 Association of Colleges and Schools of the North Central States, 422.  
 ATKINSON, G. F., 189, 199, 208, 211, 212, 214.  
 Autumn coloration, 288.  
 Auxanometer, 371.  
 Auxograph, 371.  
 AUZOUX, Dr., 166.  
 Azolla, 404.  
 Bacteria, 42; action, 323; study, 393, 420, 427; material, 397, 398.  
 BAILEY, L. H., 57, 150, 180, 202, 204, 206, 208, 214, 215.  
 BAILEY, W. W., 161, 215.  
 BAILEY and COLEMAN, 209, 215.  
 Balopticon, 169.  
 BALTHIS, F. K., 145.  
 BARNES, C. R., 99, 132, 208, 211, 215.  
 Basidiomycetes, 396.  
 BATES, *Naturalist*, 180.  
 BATESON, 179.  
 BAUSCH & LOMB OPTICAL Co., vi, 129, 132, 133, 134, 139, 169.  
 BEAL, W. J., 191, 215.  
 BELT, *Naturalist*, 181.  
 BERGEN, J. Y., 209, 211, 215, 270, 376.  
 BERGEN and DAVIS, 194, 208, 212, 215, 391.  
 BESSEY, C. E., 110, 117, 173, 207, 208, 212, 216.  
 Bibliography, 214.  
 BIGELOW, M. I., 209.  
 Biology, 28, 36.  
 BLASCHKA models, 151.  
 Bleeding, 350, 356.  
 Blue-green Algæ, 393.  
 BODWELL, BERTHA, 260.  
 Books, their use, 176; botanical, 176; reading, 177; for self-improvement, 57, 178; biography and travels, 179; essays, 179; history, 180; in libraries, 184; for reference, 184; obsolete, 185; on morphology, 186; on physiology, 188; on ecology, 190; on plant geography, 191; English only, 192; on classification, 196; on natural history, 193; popular, 195; manuals, 196; floras, 197; on lower plants, 198; on Fungi, 199; on Algæ, 200; on cultivated plants,

- Books — *continued*  
 201; sundry, 202; on teaching, 204;  
 on Nature-study, 204; text-books,  
 204; laboratory manuals, 205;  
 notebooks, 209.
- Botanical Gardens, 142; principal  
 ones in America, 143; labeling, 148.
- Botanical Gazette*, 182, 216.
- Botanical journals, 181.
- Botanical Society of America, 413, 423.
- Botany, distinctive features, 27, 29;  
 as training, 34; as knowledge, 39.
- Bottles for reagents, 136.
- BOWER and VINES, 211.
- BRENDEL, R., 166.
- BRITTON, N. L., 144, 194, 196, 197, 216,  
 245.
- BRITTON, W. E., 115.
- Brooklyn Institute, 55.
- BROOKS, S. D., 110.
- BROWN, A., 196, 197, 216.
- BROWN, E. E., 34.
- Brown Algæ, 387.
- Bryophytes, study, 399, 420, 427.
- Buds, ecology, 300; morphology, 297.
- BURBANK, L., 203.
- BUSHEE, GRACE, 84, 324.
- CALDWELL, O. W., vi, 69, 115, 206, 216,  
 391, 422.
- California University, 56.
- CAMBRIDGE BOTANICAL SUPPLY CO.,  
 107, 135, 139, 140, 162, 389.
- CAMPBELL, D., 194, 198, 211, 212, 216.
- Cambium cylinder, 243, 312, 336, 339.
- CANNING, E. J., vii, 145.
- Carbon dioxide, in air, 301; absorp-  
 tion, 302; in respiration, 316.
- Caulicle, 262.
- Cells, study, 321, 417.
- Cellular structure, 39.
- CENTRAL SCIENTIFIC CO., 139.
- Chalaza, 262.
- CHAMBERLAIN, C. J., 187, 217.
- CHAPMAN, A. W., 197, 217.
- Chicago University, 55.
- Chlorophyceæ, 386.
- Chlorophyl, solutions, 84; spectra, 84;  
 study of, 284, 286, 418; extraction  
 of, 287; distribution, 294; grains, 323.
- CHOATE, HELEN A., vii.
- Circumnutation, 376.
- CLAPP, GRACE, 84, 335.
- CLAPP, H. L., 150.
- CLARK, C. H., 206, 217.
- Clark Hall, 110.
- Class-room methods, 86.
- CLEMENTS, F. E., 189, 192, 199, 217.
- CLEMENTS and CUTTER, 206, 217.
- Climbers, 307, 419.
- Clinostat, 380.
- Club Mosses, 401.
- CLUTE, W. N., 198, 206, 214, 217.
- Cold Spring Harbor, 56.
- Collecting instinct, 392.
- Collections, 141.
- College entrance, 255.
- College Entrance Examination Board,  
 organization, 33, 44, 413, 414; col-  
 leges accepting, 421, 423.
- College entrance requirements, 12, 24.
- COLLENS, A. E., 152.
- COLLINS, F. S., 165, 200, 217.
- Companion cells, 338.
- Comparison, 36, 259.
- CONN, H. W., 200, 217.
- Correspondence courses, 57.
- Cortex, 311, 339.
- Cotyledons, 262, 275.
- COULTER, J. G., 204.
- COULTER, J. M., 197, 204, 208, 211, 213,  
 217.
- COWLES, H. C., 413.
- CRONBERGER, B., 150.
- Cross fertilization, 243.
- Cross pollination, 361; study of, 367,  
 368, 418; significance of, 369.
- Cultural value of science, 13.
- Culture, 8; value, 9; definition, 10, 23.
- CURTIS, C. C., 187, 212, 218.
- Curves, 104.
- Cycads, 408.
- Cytoplasm, 323, 336, 417.
- DAME and BROOKS, 194, 218.
- DARWIN, C., 178, 180, 190, 191, 218, 376.
- DARWIN, F., 179, 218.
- DARWIN and ACTON, 189, 218.
- DAWKINS, BOYD, 166.
- DEANE, W., 152, 160.
- DE BARY, A., 186, 199, 218.
- Decay, 323.

- Department of Agriculture, 203.  
 DETMER, W., 189, 219.  
 Development of seedlings, 283.  
 DE VRIES, 179, 203, 219.  
 DEWEY, J., 71.  
 DEWING, A. S., 209.  
 DEYROLLE, 166.  
 Diagrams of flowers, 353.  
 Diastase, 278, 282.  
 Dicotyledons, 406.  
 Differentiation in growth, 376.  
 Diffusion shell, 346.  
 Digestion, 278, 281, 418.  
 Discipline, value of, 20.  
 Diseases of plants, 200, 429.  
 Dissecting microscope, 131.  
 Dissemination of seeds, 243, 272, 274, 276, 418.  
 DIXON and JOLY, 340.  
 DODEL-PORT wall charts, 170.  
 DODGE, C. W., 117, 206, 219.  
 Dogma, 70.  
 Drawing, 89; pedagogical value, 89, 103; essential nature, 90; student's attitude towards, 91, 97; diagrammatic kind, 92; free hand, 93; paper and pencils, 94; numbers, 94; scale, 95; labeling, 96; perspective, 98; use of India ink, 99; modes of reproducing, 99; shading, 100; different kinds, 100; with microscope, 101; copying, 102; generalized, 102; preservation of, 106, 260.  
 Drill, value of, 21.  
 Drupe, 379.  
 Ducts, 336, 339.  
 DUGGAR, B. M., 200, 219.  
 EATON, D. C., 198, 219.  
 ECKERSON, SOPHIA, 84, 296, 330, 358.  
 Ecological groups, 307, 419.  
 Ecology, definition, 41; of seeds, 272; of flowers, 367; of fruits, 377.  
 Economics, 44.  
 Education, aim, 7, 11; cosmic basis, 7; problems, 3, 8; luxurizing of, 20, 21; standardization, 34.  
 Effort, value of, 20, 21.  
 EGGLING, O., 125.  
 EHRENBERG, F., 125.  
 EICHLER, 361.  
 EIMER & AMEND, 139.  
 Elective system, basis, 17; defects, 19.  
 Elimination, 40.  
 ELIOT, President, 13, 14, 22, 178, 219.  
 ELLIOTT, L. B., 110, 121.  
 ELROD, M. J., 115, 117.  
 Embryo, 262, 276.  
 Embryo sac, 349.  
 Endosperm, 266, 269.  
 ENGLER, A., 193, 219.  
 ENGLER and PRANTL, 193, 219.  
 Epicotyl, 277, 281.  
 Epidermis, 310, 329.  
 Epiphytes, 307, 419.  
 Equality of knowledge, 10, 22.  
 Equisetineæ, 403, 404.  
 ERRERA & LAURENT wall charts, 171.  
 Errors, prejudicial to teaching, 227; as to use of Botany, 228; as to untried exercises, 229; as to morphology, 230; as to phytomera, 232; as to inferior ovaries, 234; as to monstrosities, 234; as to relationships of members, 233; as to physiology, 236; as to plant food, 237; as to plant intelligence, 238; as to photosynthesis, 238; as to root pressure, 241; in use of terms, 242; as to scientific names, 244; as to respiration, 236.  
 Erythrophyl, 288.  
 Essays, 105.  
 Examinations, 87, 105.  
 Excursions, *see* Field work.  
 Exudation of water, 356.  
 FARLOW, W. G., 200, 219.  
 FARMER, J. B., 211.  
 Fermentation, 323, 326.  
 FERNALD, M. L., 196, 223.  
 FERNOW, B. E., 202, 219.  
 Fern Plants, 42, 401, 403.  
 Fertilization, 418.  
 Fibrovascular bundles, 300, 336, 337.  
 Fibrovascular system, 311, 328.  
 Field work, value of, 49, 87.  
 Filicineæ, 401.  
 FISCHER, A., 200, 219.  
 FISH, P. A., 115, 117.  
 Flowers, clusters, 367, 370; diagrams, 351, 353; ecology, 361; material,

- Flowers—continued  
 350: morphology, 359, 360; structure, 345, 417.
- Follicle, 379.
- Foods of plants, 170, 297, 310.
- Food substance of seeds, 265, 268.
- FORBES, H. O., 181.
- Formaline, 152.
- Formation of food, 296, 300.
- Form in life, 72.
- FRANK & TSCHECH wall charts, 171.
- FRONT, W. D., 117, 118.
- Fruits, morphology, 377, 379, 417; ecology, 377, 379; materials, 378.
- FUNGI, 387, 389, 390.
- Funaria, 400, 401.
- Fungi, 41: study, 393, 430, 437.
- Gametophyte, 400, 402.
- GAUSMAN, W. F., 219, 413.
- Gas table, 179.
- Gauges for root pressures, 357.
- GEORGE, P., 180, 219.
- Generalizations, 72.
- Geotropism, 380; study, 382.
- Germination, 179.
- Germination box, 179.
- GERMINATORS, 342.
- GIBSON, W. H., 101, 200, 219.
- GOEBEL, K., 181, 219.
- GOODALE, G. L., 154, 188, 220.
- GOODE, G. B., 155.
- Graphs, 104.
- GRATANF, L. P., 153.
- Gravitation, 354.
- GRAY, ASA, 171, 21, 176, 181, 180, 100, 101, 102, 201, 205, 208, 220, 245, 200, 205, 270, 272.
- GREEN, J. K., 188, 205, 220.
- Green Alga, 381.
- Greenhouses, 140.
- GRUBER, P. H., 111.
- Groups, relationships, 41, 430, 437, 438, 436.
- Groups of studies, 25.
- Group system, 76.
- GROTT, A. J., 108, 100, 120.
- Growing of seedlings, 278.
- Growing points, 344.
- Growth, 40, 377, 418; study of, 377, graphs, 376.
- Guard cells, 329, 330.
- Gymnosperms, 405; homologous, 407, 420, 428.
- HABERLANDT, 181.
- Halophytes, 307, 419.
- HARPOWELL, 56.
- HARSHBARGER, J. W., 145, 173.
- HARWOOD, W. S., 205, 221.
- HASSACK wall charts, 171.
- HEALD, F. D., 173.
- Heliotropism, 350.
- HENNINGWAY, H. D., 145, 150.
- HENNINGK, 162.
- HENRY HEIL CHEMICAL Co., 139, 140, 160, 162.
- Hepaticae, 399.
- Herbarium-making, 46, 158; methods, 100; sheets, 163.
- HERRICK, F. H., 110.
- Heterospory, 403.
- HILLARD, E. W., 202, 221.
- Hilum, 202, 275.
- HOBBS, C. F., 50, 204.
- HOLTE, F. L., 204.
- HOLSTEIN, 403.
- HOLTON, R. B., 164, 194, 221.
- HOWARD, O., 173.
- HOWES, E. G., 204.
- HUDSON, W. H., 181.
- Humanistic spirit, 65, 69.
- Humidities in Sciences, 11, 15, 23.
- HUNTER, G. W., 27, 208, 221.
- HUXLEY, L., 179, 221.
- HUXLEY, T. H., 15, 22, 178, 221.
- HUXLEY and MARTIN, 205, 211, 221.
- Hydrophytes, 307, 419.
- Hydrotopism, 350; study, 354.
- Hypocotyl, 202, 275, 380.
- Ideals in education, 2, 7.
- Identification courses, 40; place of, 48.
- Imagination in science, 14, 71.
- Intractable exercises, 29.
- Interior cavity, morphology, 360.
- Information, value of, 22.
- Insectivora, 307, 419.
- Instruments and cases, 133.
- Intelligence in plants, 238.
- Interest, as pedagogical method, 68, 72.
- International Congress, 196, 245.

- Interpretation of knowledge, 60.  
 Investigation spirit, 77; by teachers, 53, discussion, 58, 177.  
 Iodine solution, 296.  
 Irritability, 40, 238, 377, 380; nature, 385, 418.
- JACKSON, B. D., 203, 221.  
 JORDAN, E. O., 200, 221.  
 JOST, L., 188, 221.  
*Journal of Applied Microscopy*, 221.  
 Journals, botanical, 181.  
 Jungermannia, 401.  
 JUNG wall charts, 171.
- KARSTEN and SCHENCK, 167, 192, 194, 221.  
 KARSTEN, G., 194.  
 KELLERMAN, W. A., 162.  
 KERNER von MARILAUN, A., 191, 221.  
 KERNER and OLIVER, 305.  
 Klinostat, *see* Clinostat.  
 KNOTT SCIENTIFIC APPARATUS CO., 139, 209.  
 KNUTH, K., 190, 221.  
 KNY wall charts, 170, 390.  
 KNY-SCHEERER CO., 140, 166, 172.  
 KOHL wall charts, 171.  
 KRAEMER, H., 203, 213, 221.
- Labels, for gardens, 148; for museums, 157; for bottles, 157.  
 Laboratory, administration, 54; attractiveness, 66; value, 73; place, 74; periods, 74, 415, 424; divisions, 74; management, 75; neatness, 75; spirit, 77; examine work, 79, 107; drawing in, 89; notes, 104; materials, 137; equipment, 109; room, 110; unit system, 111; sizes, 111; furniture, 115; tables, 115; chairs, 118; arrangement, 120; equipment, 124; materials, 137; glassware, 137; fees, 138; cost of equipment, 138; supply companies, 139; use, 174; manuals or guides, 205.
- LAMARCK, 179.  
 Lanterns, 168.  
 Lantern slides, 168.  
 Leaves, anatomy, 328, 416; morphology, 303, 416.
- LEAVITT, R. G., 208, 222.  
 Lectures, 87.  
 Legume, 379.  
 LEITZ, ERNST, 129, 169.  
 Leland Stanford, 56.  
 LEMAOUT and DECAISNE, 193, 222, 361.  
 Lenticels, 299, 313.  
 LESQUEREUX and JAMES, 198, 222.  
 Lichens, 42, 395, 397, 420, 427; nature, 398.  
 Light screens, 294.  
 Liverworts, 42; Study, 399.  
 Living plants, 251.  
 LLOYD, F. E., vi, 29, 117, 122, 153, 160, 204, 413.  
 LLOYD and BIGELOW, 29, 204, 222.  
 Lockers, 119.  
 Locomotion of seeds, 243.  
 LOCY, W. A., 180, 222.  
 LOWSON, 211.  
 LUBBOCK, J., 180, 190, 222.  
 Lycopodineæ, 402, 404.  
 Lyman Plant Houses, vii, 143.
- MACBRIDE, T. H., 200, 206, 222.  
 MacDonald College, 151.  
 MACDOUGAL, D. T., 180, 188, 189, 222.  
 MACFARLANE, J. M., 155.  
 MACILVAINE and MACADAM, 199, 222.  
 Manuals, 196; use of, 46, 411, 421; more useful, 49.  
 Marchantia, 399, 400.  
 Marine Biological Laboratory, 55.  
 MARSH, C. D., 110.  
 MASSEE, G., 199, 222.  
 Medullary rays, 338, 339.  
 Megaspore, 352, 407.  
 MEIER, W. H. D., 209.  
 MENDEL, 179.  
 Mesophytes, 307, 419.  
 Method in science, 71.  
 Micropyle, 262, 275.  
 Microscope, 40; use of, 321, 324; standardization, 126; optimum standard, 126; specifications, 127; manufacturers, 129; number needed, 129; storage of, 130; dissecting, 131.  
 Microspore, 352, 407.

- MIGULA wall charts, 171.  
 Mildews, 397.  
 Minnesota University, 56.  
 MINOT, C. S., 111, 113.  
 Models, 166.  
 Molds, 394, 397.  
 Monocotyledons, 406.  
 Monstrosities, 235.  
 Morphology, nature, 37, 293; illustrations, 267; of seeds, 264; of buds, 297; of leaves, stems, and roots, 303; of flowers, 359; of fruits, 377.  
 Mosses, 42; study, 400.  
 MÜLLER, H., 190, 222.  
 MURBACH, L., 110, 125.  
 MURRAY, G., 200, 222.  
 Musci, study, 400.  
 Museums, 152; methods, 152; preservatives, 152; bottles, 153; containers, 154; labels, 155, 157; plan, 156; herbaria, 158; anatomical preparations, 164.  
 Mushrooms, 396.  
 Mycophytes, 398.  
 Myrmecophila, 307.  
  
 National Education Association, 20.  
 Natural History, study, 390.  
*Nature*, 182, 222.  
 Nature, love for, 70; faking, 70.  
*Nature-Study Review*, 183, 204, 223.  
 Nature-study, status, 4; value, 16, 414.  
 Nectar glands, 361.  
 NELSON, A., 197, 223.  
 NEWELL, JANE H., 206, 223.  
*New Phytologist*, 183, 223.  
 Nodes, 292.  
 NOLL, F., 188.  
 Nomenclature, of plants, 196; schools of, 245.  
 Normal apparatus, 134, 135.  
 Nucellus, 262.  
 Nucleus, 2, 323, 336.  
  
 Observation, 34; nature, 34; training, 35, 258.  
 Ecology, *see* Ecology.  
 Optimum course, nature, 30; desirability, 32; content, 34, 249.  
  
*Origin of Species*, 178.  
 ORTH wall charts, 171.  
 OSBORN, H. F., 179.  
 OSBORN, H. L., 154.  
 Osmoscopes, 344.  
 Osmosis, 340.  
 Osmotic phenomena, 359, 364.  
 Osmotic pressure, 366.  
 OSTERHOUT, W. J. V., 189, 223, 270, 376.  
 OSTERLOH, P., 166.  
 Outlines, construction of, 252; value of, 253.  
 Ovary, morphology, 233, 361.  
 Ovules, morphology, 230, 349, 351, 352.  
 Oxygen, needed for growth, 317; release, 304, 307.  
  
 PACKARD, A. S., 179.  
 Parasites, 286, 307, 419.  
 Parmelia, 395.  
 PATTERSON, ALICE J., 204.  
 PEARSON, K., 179.  
 Pedagogical methods, 64, 108.  
 PEIRCE, G. J., 140, 188, 223.  
 Pencils, 94.  
 PENHALLOW, D. P., 195, 223.  
 PEPOON, MITCHELL and MAXWELL, 207, 223.  
 Perianth, 351; morphology, 353.  
 Petals, 351.  
 PETER wall charts, 171.  
 PFEFFER, W., 169, 188, 223.  
 Phæophyceæ, 387.  
 Phloem, 339.  
 Photographs, value of, 167.  
 Photosynthesis, 40; study of, 286, 294, 418; light in, 309.  
 Photosynthetic equation, 307; quantities, 309.  
 Photosynthometer, 309.  
 Phototropism, 380.  
 Phycomycetes, study of, 394.  
 Phycophytes, 393.  
 Phyllotaxy, 285, 291, 292, 293.  
 Phytomera, 232, 292.  
 Plant physiology, experimenting, 37; processes, 40; teaching to large classes, 80; logical quality, 81; control experimenting, 81; fallacious

- experiments, 82; logical exposition, 83; studies on better materials, 83; neatness in experimenting, 85; make-shift tools, 85; projection of experiments, 169.
- PINCHOT, G., 202, 223.
- Pines, 405, 407.
- Pistil, homologies, 352.
- Pitchers, 305, 306.
- Plant food, 237.
- Plant World*, 183, 223.
- Plasmolysis, 366.
- Plastids, 326.
- Pleurococcus, 386, 388, 391, 392, 393.
- Plumule, 262, 275, 280.
- Poetry in laboratories, 70.
- Pollen, 351.
- Polysiphonia, 388, 390.
- Practical training, 8.
- Pressure gauges, 357.
- Prothallia, material, 404.
- Protoplasm, 39, 322.
- Protoplasmic streaming, 84, 324.
- Psychology, 54.
- Pteridophytes, study, 401, 420, 427.
- Racks for diagrams, 118.
- Radicle, 262.
- RANDOLPH, HARRIET, 206, 223.
- Raphe, 262, 275.
- Records of work, preservation, 106.
- Red Algae, 388.
- REED, H. S., 153.
- Reflectoscope, 169.
- REICHERT, C., 129.
- Religion, 70.
- Reproduction, 40.
- Requirements in study, 18.
- Respiration, 40, 312, 314, 418; quantities, 320.
- Respiratory equation, 320.
- Respiroscopes, 317.
- Responsibility, value of, 21.
- Rhodophyceæ, 388.
- Rhodora*, 182, 223.
- Riccia, 400.
- RIKER, mounts, 160; press, 162.
- ROBINSON, B. L., 161, 196, 197, 223.
- ROMANES, G. J., 179.
- Root absorption, 349, 356.
- Root-cap, 344.
- Root, pressures, 84; exudation, 84.
- Roots, anatomy, 341, 417; morphology, 303, 417.
- ROSTOWZEW, S., 117, 162.
- Rusts, 397.
- Saccharomycetes, 394.
- SACHS, 179, 203, 211, 223.
- ST. LOUIS BIOLOGICAL LABORATORY, 140, 165, 168.
- Salvinia, 404.
- Sap ascent, 340.
- Saprophytes, 307.
- SARGENT, C. S., 194, 224.
- SARGENT, F. L., 202, 224.
- SCHENCK, H., 194.
- SCHIMPER, A. F. W., 167, 191, 224, 305.
- Schizomycetes, 393.
- SCHNEIDER, A., 199, 224.
- School Gardens, 150.
- School Science*, 183, 224.
- Science*, 182, 224.
- Science, definition, 13; knowledge value, 14.
- Sciences, classification, 26; vs. humanities, 11, 23.
- Scientific conventions, 56, 63.
- Scientific method, definition, 34.
- Sclerenchyma, 338.
- SCOTT, D. H., 203, 224.
- Scutellum, 269.
- SEDGWICK and WILSON, 205, 224.
- Seed coat, 262, 275.
- Seed Plants, 42; study, 405.
- Seedlings, 276.
- Seeds, structure, 257; collecting, 263; ecology, 272; morphology, 264, 416, 425; adaptations, 275; essay on, 275.
- Selaginella, 402, 404, 405.
- Semi-permeable membranes, 347, 367.
- Sepals, 351.
- SETCHELL, W. A., 206, 224.
- SEWARD, A. C., 179.
- Sex organs, 244.
- Shoot, 233, 416.
- Sieve tubes, 336, 338, 339.
- SMALL, J. K., 197, 224.
- SMITH, J., 202, 224.
- Smuts, 397.

- SOLEREDER, H.**, 186, 224.  
**SOLMS-LAUBACH**, 203, 224.  
**SORACER, P.**, 188, 225.  
 Space markers, 371.  
**SPALDING, V. M.**, 206, 225.  
 Spectroscope, 310.  
**SPENCER LENS CO.**, 129.  
 Spermatophytes, 405, 407.  
 Spines, 305.  
**SPIROGYRA**, 389, 392, 393.  
 Sporophyte, morphology, 230.  
 Sporophyte, 400, 401.  
**SPOTTON, H. B.**, 208, 225.  
**SPRICE, R.**, 181.  
 Stamen hairs, 323.  
 Stamens, morphology, 352.  
 Standard course, 250, 413.  
 Starch formation, 84, 290.  
 Stems, anatomy, 335, 416; morphology, 305, 410.  
 Stereopticons, 108.  
**STEVENS, W. C.**, 187, 211, 225.  
**STOELTING CO.**, 135, 139.  
 Stomata, 243, 313, 331, 335; numbers and sizes, 84, 330.  
**STONE, G. E.**, 111, 152.  
**STONEMAN, BERTHA**, 211.  
**STRASBURGER, E.**, 57, 187, 188, 194, 225.  
**STRASBURGER, NOLL, SCHEENCK, and KARSTEN**, 213, 225.  
 Strophole, 202.  
 Students, dull and bright, 76.  
 Summer schools, value, 54, 55.  
 Supply Companies, 130.  
 Symbionta, 307.  
 Synthate, 200.  
 Synthetic course, 43, 424.  
 Teacher, training, 25, 52; qualities, 26; progress, no. 62, 170; characteristics, 61, 65, 66; qualifications, 420.  
 Teaching, of sciences, 24; attributes, 65; simplicity, 67; interest, 68, 72; methods, 75; devices, 78.  
 Technical schools, efficiency, 20.  
 Tendrils, 305.  
 Testing of probabilities, 57.  
 Text-books, 204.  
 Thallus, 387.  
 Theorizing in Biology, 273.  
**THOMAS**, 211.  
**THOMPSON, A. T., Co.**, 169.  
 Tissues diagram, 314.  
 Tissue systems, 310, 312, 337, 338; table of, 339.  
*Toveys*, 182, 225.  
*Tovey Club Bulletin*, 182, 216.  
**TOWER** microphotographs, 171.  
**TRACY, MARTHA**, 173.  
 Transfer of water, 337, 340, 418.  
 Transpiration, 329; quantities, 84, 334, 418; study, 331, 335.  
 Transpirograph, 334.  
 Transport, 40.  
**TRIASWELL, A. L.**, 110.  
 Tree of relationship, 409.  
 Tubers, 305.  
**TUBEUF, VON**, 200, 225; wall charts, 170.  
 Tufts College, 56.  
 Turgidity, 364, 418.  
 Twigs, 297.  
**UNDERWOOD, L. M.**, 198, 199, 225.  
 Unit courses, 44.  
 Vacuoles, 323.  
*Vaucheria*, 386, 389, 392.  
**VERWORN, M.**, 188, 225.  
**VINES, S. H.**, 211, 213, 225.  
 Vocational education, 9.  
**VORCHTLÄNDER**, 129.  
**WAEL, M.**, 226.  
 Wall charts, or diagrams, sets for sale, 170; home made, 172; storage of, 173.  
**WALLACE, A. R.**, 180, 226.  
**WARD, H. M.**, 203, 226.  
 Wardian cases, 122.  
 Ware collection of models, 151, 156.  
**WARING, E.**, 192, 194, 226.  
**WARREN, G. F.**, 202, 226.  
 Washington University, 56.  
 Water transport, 357, 340.  
**WATERS, C. E.**, 198, 226.  
**WATSON, S.**, 197.  
**WEED, C. M.**, 191, 226.  
**WEISMANN**, 179.  
**WHITALL TATUM CO.**, 139, 154.  
**WILDER, H. H.**, 117.  
**WILLIAMS BROWN & EAMES**, 199, 269.



- WILLIS, J. C., 202, 226.  
Window gardens, 122, 145.  
Winter buds, 297.  
WOODS, A. F., 152.  
Woods Hole Biological Laboratory, 140.  
Wood sections, 164.  
WRIGHT, F. R., 117.  
WYLIE R. B., 110.
- Xanthophyl, 288.  
Xerophytes, 307, 419.  
Xylem, 339.
- Yeasts, 42, 323, 420, 427; study, 394; material, 397.
- ZEISS, CARL, 129, 169.  
Zoölogy, 27, 29.



